

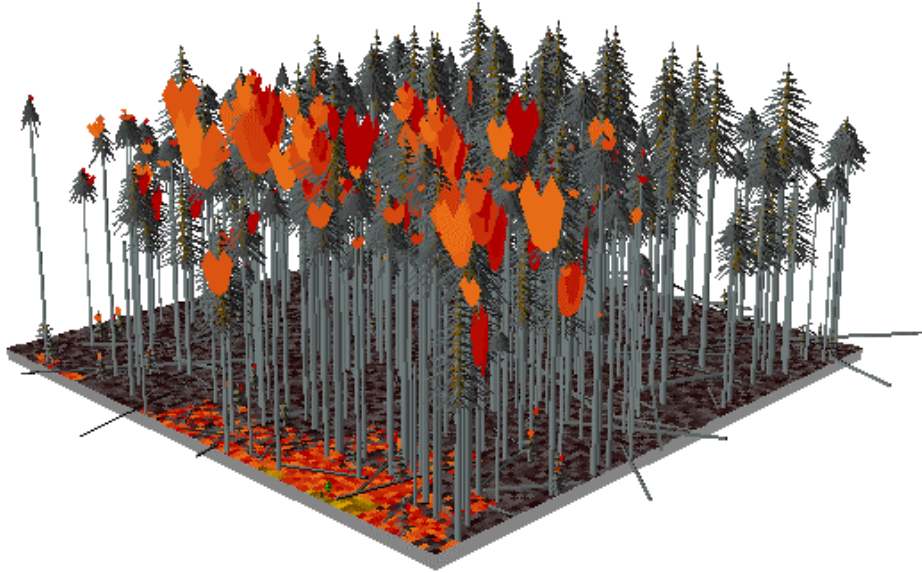

The Fire and Fuels Extension to the Forest Vegetation Simulator

Technical Editors:
Elizabeth D. Reinhardt
Nicholas L. Crookston



Wildfire only

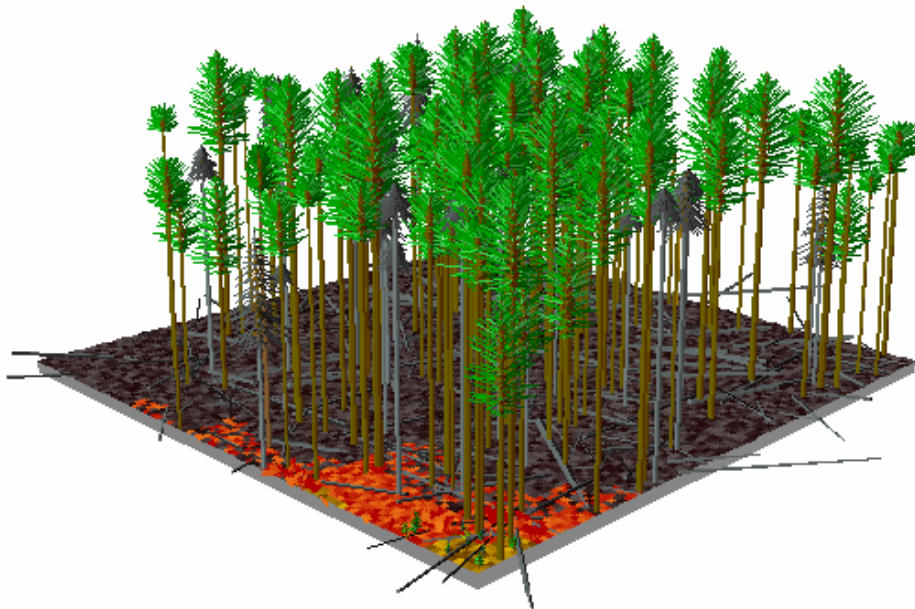

With prescribed fire

Abstract

Reinhardt, Elizabeth; Crookston, Nicholas L. (Technical Editors). 2003. **The Fire and Fuels Extension to the Forest Vegetation Simulator**. Gen. Tech. Rep. RMRS-GTR-116. Ogden, UT: U.S. Department of Agriculture, Forest Service, Rocky Mountain Research Station. 209 p.

The Fire and Fuels Extension (FFE) to the Forest Vegetation Simulator (FVS) simulates fuel dynamics and potential fire behaviour over time, in the context of stand development and management. Existing models of fire behavior and fire effects were added to FVS to form this extension. New submodels representing snag and fuel dynamics were created to complete the linkages.

This report contains four chapters. Chapter 1 states the purpose and chronicles some applications of the model. Chapter 2 details the model's content, documents links to the supporting science, and provides annotated examples of the outputs. Chapter 3 is a user's guide that presents options and examples of command usage. Chapter 4 describes how the model was customized for use in different regions.

Fuel managers and silviculturists charged with managing fire-prone forests can use the FFE-FVS and this document to better understand and display the consequences of alternative management actions.

Keywords: FVS, FFE, forest fire, stand dynamics, FOFEM, BEHAVE, NEXUS, snags, coarse woody debris

The Authors

Elizabeth D. Reinhardt is a Research Forester in the Prescribed Fire and Fire Effects Project at the Rocky Mountain Research Station, Missoula Fire Sciences Laboratory, Missoula, MT. She has degrees in English (A.B., Harvard University), and forestry (M.S. 1982, and Ph.D., 1991, University of Montana). Her research has included studies of tree mortality, fuel consumption, modeling fire effects, and canopy fuels. For this publication, she was both an author and technical editor of the entire volume.

Nicholas L. Crookston is an Operations Research Analyst at the Forest Service Rocky Mountain Research Station, Forestry Sciences Laboratory, Moscow, ID. His work involves development and applications of the Forest Vegetation Simulator, its extensions, and user interface. For this publication, he was both an author and lead project manager and technical editor.

Sarah J. Beukema is Senior Systems Ecologist at ESSA Technologies, Vancouver, Canada. Some of her research interests include modeling fire dynamics, the simulation of pest and disease dynamics, and successional dynamics. She is also the principal developer of the Vegetation Dynamics Tool (VDDT) and a codeveloper of the Tool for Exploratory Landscape Scenario Analyses (TELSA). Ms. Beukema obtained a M.Sc. degree in Zoology and Applied Mathematics from the University of British Columbia.

Werner A. Kurz is a Senior Research Scientist with Natural Resources Canada at the Canadian Forest Service in Victoria, BC, Canada. His research interests are stand, landscape, and regional models of ecosystem carbon dynamics. With a group of scientists, he is currently developing a National Forest Carbon Accounting Framework for Canada. Dr. Kurz obtained his Ph.D. degree in forest ecology from the University of British Columbia in 1989 and worked for a research and consulting company until joining the Canadian Forest Service in 2001. He is an adjunct professor at the University of British Columbia and at Simon Fraser University.

Julee A. Greenough is Systems Ecologist at ESSA Technologies, Vancouver, Canada. Her research interests include the integration of timber and nontimber values into the landscape planning process. She is the principal developer of the Prognosis Environmental Indicators model; a habitat model that integrates customized Geographic Information System (GIS) components, the FVS Parallel Processing Extension, the Fuel and Fire Effects extension, the Western Root Disease extension, and habitat-projection models for a number of animal species. Dr. Greenough received her Ph.D. degree in theoretical biology from the University of Oxford.

Donald C.E. Robinson is Systems Ecologist at ESSA Technologies, Vancouver, Canada. His research interests include modeling fire dynamics, the simulation of pest and disease dynamics, and modeling forest dynamics at the individual, stand, and landscape level. He is principal developer of a spatial statistical model for the spread of dwarf mistletoe. He also continues to assist in the introduction of FVS as a forest management tool in Canada. Mr. Robinson obtained his M.Sc. degree in Zoology from the University of British Columbia.

Duncan C. Lutes is a Research Forester with Systems for Environmental Management, stationed at the Missoula Fire Sciences Lab in Missoula, MT. He has a B.S. and M.S. in Forestry from the University of Montana. His background is in fuels, principally coarse woody debris, primarily studying spatial and temporal distributions. He has been involved in the development of the FOFEM model and is currently program lead for the FIREMON fire effects monitoring project. He has been involved in the development of several Fire and Fuels Extension variants.

The use of trade or firm names in this publication is for reader information and does not imply endorsement by the U.S. Department of Agriculture of any product or service

You may order additional copies of this publication by sending your mailing information in label form through one of the following media. Please specify the publication title and number.

Telephone (970) 498-1392

FAX (970) 498-1396

E-mail rschneider@fs.fed.us

Web site <http://www.fs.fed.us/rm>

Mailing Address Publications Distribution
Rocky Mountain Research Station
240 West Prospect Road
Fort Collins, CO 80526

The Fire and Fuels Extension to the Forest Vegetation Simulator

Technical Editors:

Elizabeth D. Reinhardt
Nicholas L. Crookston

Model Availability and Support

USDA Forest Service, Forest Management Service Center, Fort Collins, CO, provides technical support and software distribution for the Fire and Fuels Extension to the Forest Vegetation Simulator (FFE-FVS). The Center may be reached through: Web site <http://www.fs.fed.us/fmsc>; phone (970) 295-5770; e-mail wo_ftcol_fvs@fs.fed.us; or address Forest Management Service Center, Natural Resources Research Center, 2150A Center Avenue, Suite 341A, Fort Collins, CO 80526-1891 USA.

Acknowledgments

This work was a collaborative effort between the Fire Effects Research Work Unit of the USDA Forest Service, Rocky Mountain Research Station, Fire Sciences Laboratory in Missoula, MT, and of the Forest Ecosystem Processes Research Work Unit, Forestry Sciences Laboratory, Moscow, ID. ESSA Technologies, Ltd, of Vancouver British Columbia, provided crucial professional services. National Forest Systems and the Joint Fire Sciences Program of the Departments of the Interior and Agriculture supported the work.

Collectively, the authors of the papers published in this volume thank the following people. Albert R. Stage encouraged the project team members throughout the project, attended workshops, and reviewed manuscripts. Jim Brown and Stage co-led this work at the beginning, found resources, and mentored our work. To a large degree the lifetime of work from Brown and Stage is merged in this project. The team received extremely helpful reviews on the *Model Description* from Jane Kappler-Smith, Paul Langowski, and Al Stage. David Atkins, Jamie Barbour, and Paul Stancheff reviewed the *Preface*. The *User's Guide* was reviewed by Renee Lundberg and Glenn Christensen, and the *FFE Variants* chapter was reviewed by Stephanie Rebain, Elizabeth Reinhardt and Nick Crookston. Casey Teske evaluated the model behavior. Stephanie Rebain found and fixed many problems, and greatly improved the model's performance.

The following people participated in one or more workshops, held to specify the components of the FFE, to calibrate it for specific regions, or both. The free flow of information and ideas at these workshops was key to the success and adaptation of this model.

Asherin, Lance	Maffei, Helen
Atkins, David	McGaughey, Bob
Bahro, Berni	Mincemoyer, Scott
Barber, Klaus	Newton, Rick
Becker, Rolan	Omi, Phil
Beighley, Mark	Ortega, Aaron
Brown, Jim	Ottmar, Roger
Burgan, Bob	Reeberg, Paul
Bushnell, Wayne	Rich, Tim
Carter, Allen	Russel, Jim
Chappell, Linda	Ryan, Kevin
Close, Kelly	Sandberg, David V. "Sam"
Cutler, Kristi	Sapsis, Dave
Dallison, Dave	Schmidt, Marcus
David, Lance	Schulte, Darrell
Dixon, Gary	Shepperd, Wayne
Ferguson, Dennis	Shoun, Dan
Foran, Joe	Siemers, Roger
Gleason, Paul	Smith, Eric
Greenhalgh, Kevin	Snell, Ken
Greer, Kendrick	Soper, Kim
Gregg, Tommy	Stage, Albert R.
Hardy, Colin C.	Stiller, Elizabeth "Bitsy"
Hermit, Ray	Teck, Richard
Higgins, Bruce	Thompson, Gary
Holthausen, Dick	Till, Ken
Husari, Susan	Tiné, Paul
Kolu, Maxine	Truman, Russ
Krivacek, Janet	van Wagtendonk, Jan
Johnson, William	VanderLinden, Larry
Landram, Michael	Vickery, Chuck
Langowski, Paul	Weltch, Mike
Larsen, Mike	Wiitala, Marc
Lasko, Rich	Wilson, Larry
Laudenslayer, Bill	Wine, Dale
Long, Donald	Winkler, Fred
Lutes, Duncan	Woods, Mark

Contents

	Page
Chapter 1 Purpose and Applications	1
1.1 Introduction	1
1.2 An Example	2
1.3 Applications	8
1.4 Conclusions	9
Chapter 2 Fire and Fuels Extension: Model Description	11
2.1 Introduction	11
2.2 Model Structure	12
2.3 Snag Submodel	15
2.4 Fuel Submodel	24
2.5 Fire Submodel	43
2.6 Discussion	59
Chapter 3 User's Guide	61
3.1 Introduction	61
3.2 Simple Run	62
3.3 Initializing the Model	64
3.4 Fires	65
3.5 Adjusting Snag Parameters	74
3.6 Adjusting Fuel Parameters	78
3.7 Management	80
3.8 Output Keywords	86
3.9 Using the FVS Event Monitor	89
Chapter 4 Variant Descriptions	93
4.1 Introduction	93
4.2 Northern Idaho (NI)	95
4.3 Eastern Montana (EM)	104
4.4 Southern Oregon/Northern California (SO)	114
4.5 Central Rockies (CR)	127
4.6 Utah (UT)	139
4.7 Western Sierras (WS)	149
4.8 Eastern Cascades (EC)	159
4.9 Central Idaho (CI)	174
4.10 Tetons (TT)	185
4.11 Blue Mountains (BM)	193
References	203
Keyword Index	207

Nicholas L. Crookston



Chapter 1

Purpose and Applications

Abstract—The Fire and Fuels Extension (FFE) to the Forest Vegetation Simulator (FVS) simulates fuel dynamics and potential fire behavior over time, in the context of stand development and management. This chapter provides an introduction to the model by illustrating its purpose and chronicling some of the applications it has supported.

Keywords: FVS, FFE, forest fire, stand dynamics, FOFEM, BEHAVE, NEXUS, snags, coarse woody debris

1.1 Introduction

Fire is now represented in the Forest Vegetation Simulator's (FVS) predictions of forest stand dynamics. At long last! Al Stage (1973) recognized the importance of including disturbance agents in stand projections when he included mountain pine beetle-caused mortality of lodgepole pine in the first release of the FVS parent model, the Prognosis Model for Stand Development.

Furthermore, long-term stand dynamics are now included in simulations of fires and fire effects. Fuel managers have a tool, the Fire and Fuels Extension to FVS (FFE-FVS), to evaluate the effectiveness of proposed fire and fuel management treatments in the context of potential fire effects on short- and long-term stand dynamics, important to silviculture, wildlife habitat, and fuel hazard.

Adding fire to FVS was accomplished by programming an extension to FVS largely based on existing models of fire behavior (including crowning) and fire effects. New dynamic models that represent snag dynamics and down

wood decomposition were constructed to complete the system. The details of these components and their scientific support are the subject of chapter 2, "Model Description." Chapter 3 "User's Guide," presents options and examples of command usage. Chapter 4, "FFE Variants," summarizes the changes made to customize the model for different geographic regions.

FFE-FVS is based on a huge legacy of research, generally dating to the middle of the 20th century. Contemporary contributors include many who attended meetings and workshops where there was a free flow of knowledge, data, and inspiration. Their names are listed in the acknowledgments.

Other papers have been published that introduced the model at various meetings and symposia. Beukema and others (1997) reported the first introduction to the FFE-FVS at the FVS conference held in Ft. Collins, CO, in February 1997. An updated introduction was presented at the Joint Fire Science Conference and Workshop held in Boise, ID, in June 1999 (Beukema and others 2000).

The need for this work and the way that this model fits into the fire-modeling toolbox was the subject of a meeting held in Seattle, WA, in February 1999 (Kurz and Beukema 1999). That meeting led to the development of the research program subsequently funded by the interagency Joint Fire Science Program. Crookston and others (1999) presented a summary of the findings from that meeting and highlighted the workshop methods.

What follows in this paper is an example that demonstrates the kinds of outputs the model produces and the dynamic interactions between the fire, fuel, and tree growth components. Following the example is a summary of some of the applications recorded to date. These document the range of the model's applicability from the stand to regional levels and include the use of the model in conjunction with other FVS extensions that represent insects and diseases.

1.2 An Example

The main use of the FFE-FVS is to support fuel management and postfire treatment decisions in the context of other vegetation management concerns, including wildlife habitat, insect and pathogen hazards, and timber production. FFE-FVS displays measures of fire hazard as they change during the course of stand development and in response to management actions and other disturbances.

The following example displays a few of the many FFE-FVS outputs. It is taken from a Forest Inventory Analysis (FIA) plot on the Flathead National Forest in western Montana. The forest type is Douglas-fir, although the potential type is classified as subalpine fir. While there is little species diversity, there is a great deal of variation in tree size, ranging from seedlings to trees over 30 inches in diameter.

Two simulation scenarios are offered. The first, named *Wildfire only*, includes a simulated wildfire in the year 2065 and was run with no other management actions. The second is like the first except that a series of prescribed fires was simulated prior to the wildfire and is therefore named *With prescribed fire*. A series of figures show the results of running these two scenarios. The variables were chosen to illustrate the relevance of the model outputs to various disciplines and to demonstrate the dynamic interactions between fire, fuel, and tree dynamics. There are many more variables that could be displayed, and many more scenarios on many more stands could be run.

1.2.1 Output for Everyone: Stand Visualization

The Stand Visualization System (SVS, McGaughey 1997) can create images like the ones illustrated in figure 1.1. The images (reproduced in color on the cover) show how the fire behavior differs during the wildfire under the two scenarios. In the *Wildfire only* case, the fire is burning in the crown, while the *With prescribed fire* case exhibits some torching. Images like these can be made for each time period of a simulation and viewed on computers as a time-lapse sequence showing the dynamic changes that take place in a stand. The software needed to construct these sequences is freely available and includes linkages to FVS.

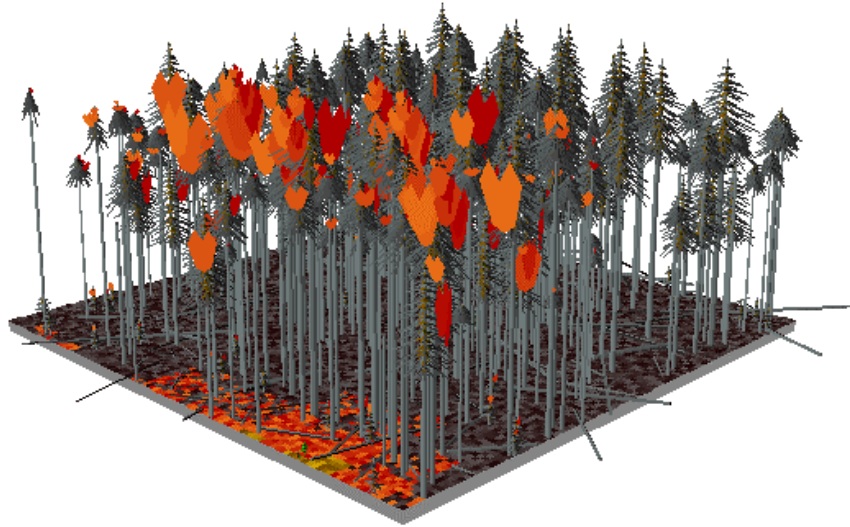

Wildfire only

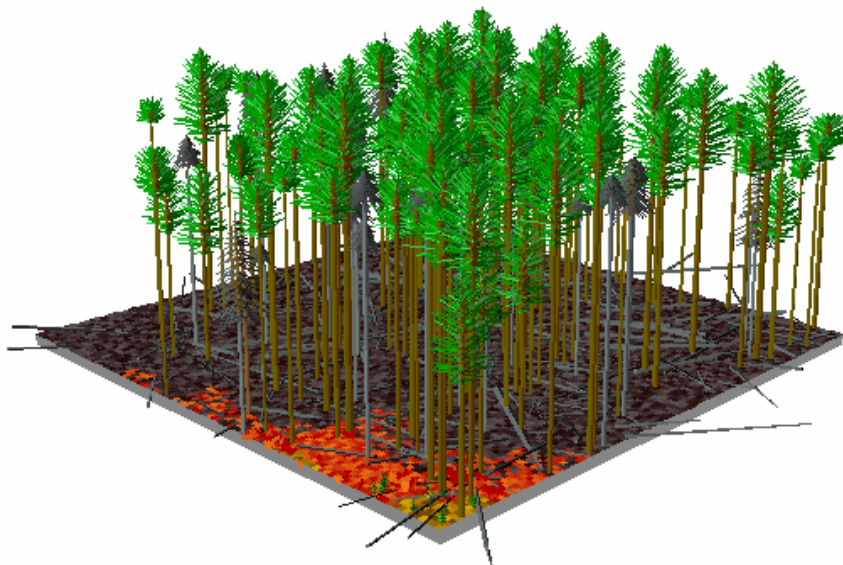

With prescribed fire

Figure 1.1—Stand Visualization System (McGaughey 1997) images show how the fire behavior is different during the 2065 wildfire under the two scenarios. In the *Wildfire only* case (top), the fire is burning in the crown, while in the *With prescribed fire* case only a surface fire is burning (bottom).

1.2.2 Outputs for Fire and Fuel Managers

The potential flame length indicates the expected fire intensity if a fire were to burn. It is computed over the duration of the simulation period using the same logic as used to simulate a fire except that no fire effects are included. Figure 1.2 illustrates that the *Wildfire only* case provides a rather static potential flame length until the year 2060 when it increases dramatically. This is due to a reduction in canopy base height and other factors that result in the FFE predicting that fuels would support an active crown fire. Consequently, the wildfire simulated in year 2065 is classified as a crown fire and results in 100 percent tree mortality. Following the fire, the potential flame length dips sharply due to fuel consumption, and then increases because of the increase of dead surface fuels that accumulate immediately after the fire as a result of fire-caused tree mortality. In the *With prescribed fire* scenario, a pattern of reduction and increase in potential flame length follows the prescribed fires.

Figure 1.3 shows changes in crowning index, the wind speed necessary to sustain crown fire. The series of prescribed fires in the *With prescribed fire* scenario increased the crowning index from 15 to 20 miles per hour until after the severe fire simulated at 2065. The huge increase in the crowning index under the *Wildfire only* scenario is due to the lack of overstory trees in which the fire can burn.

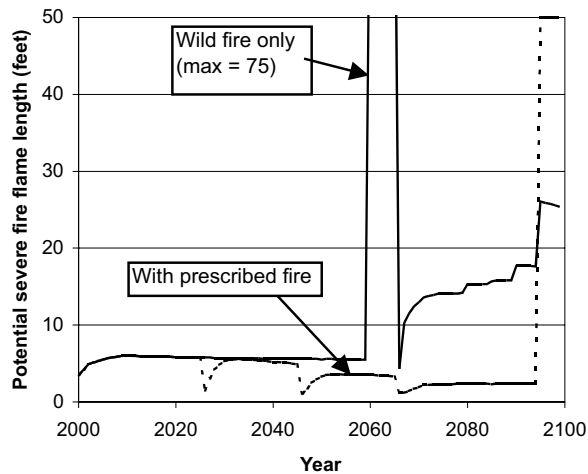

Figure 1.2—The potential fire flame length for severe burning conditions is illustrated for both scenarios. The *With prescribed fire* scenario has a much lower potential flame length in this example until the end of the simulation when it jumps up to 50 feet.

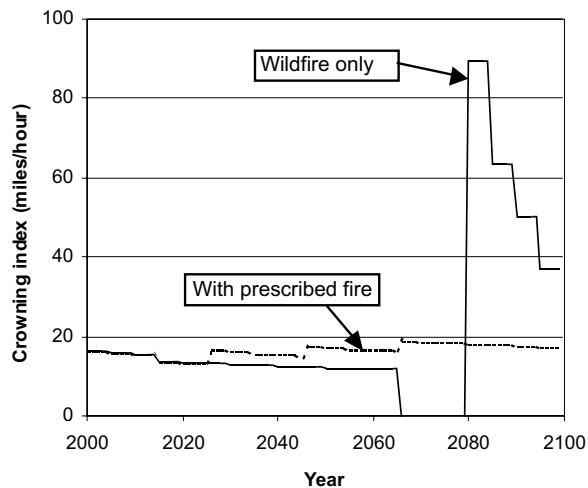

Figure 1.3—Crowning index is the wind speed necessary to cause a fire that is torching trees to become a running crown fire.

1.2.3 Outputs for Silviculturists and Fuel and Wildlife Managers

The surface fuel load in tons per acre is an indicator for fuel managers because generally, the more there is, the greater the fuel hazard. Figure 1.4 shows total weight of woody fuels summed over all size classes. To wildlife and vegetation managers, this fuel is considered coarse woody debris, and that is often a valuable resource. The *Wildfire only* scenario shows consistently high fuel loads while the *With prescribed fire* scenario shows that surface fuels are reduced by the prescribed fires. In general, however, the reductions are short lived as the trees killed by the prescribed fires create surface dead material soon after each prescribed fire.

Snags are less important to fire behavior than down fuel yet can be important to wildlife habitat management (fig. 1.5). The *Wildfire only* scenario shows a slow, steady, increase in snag numbers with a peak after the wild fire. The *With prescribed fire* scenario shows an early increase and a smaller spike after the fires of 2065.

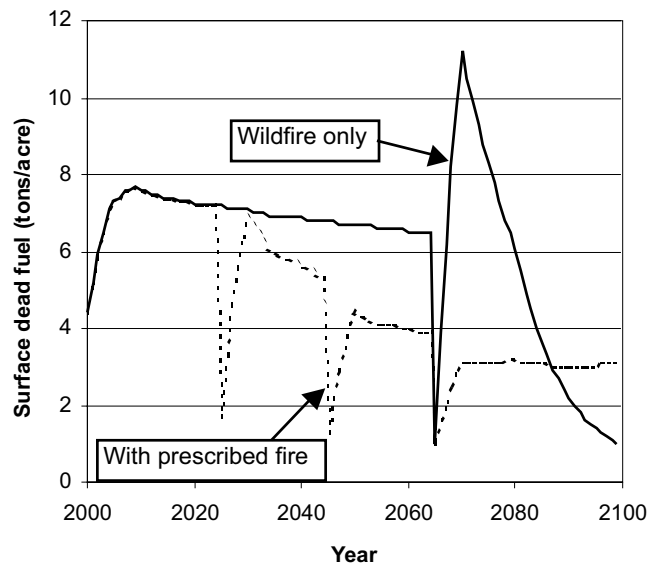

Figure 1.4—Surface fuel loads are of interest to fuel managers. To wildlife and vegetation managers this variable measures coarse woody debris. For the *Wildfire only* scenario, the model predicts surface fuel decomposition exceeds accumulation after the initial accumulation.

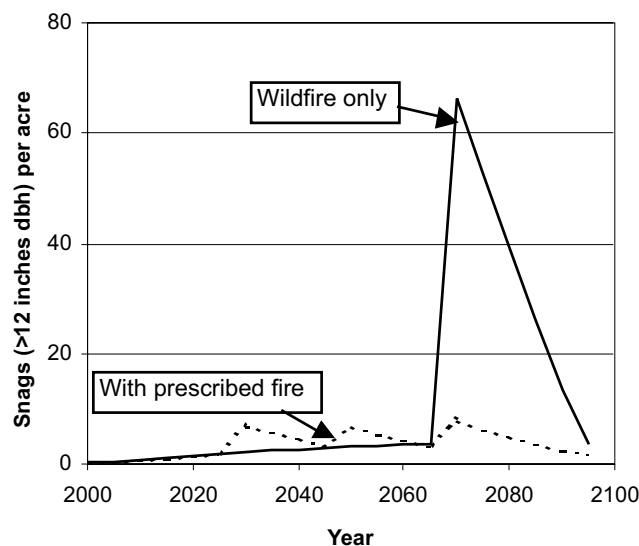

Figure 1.5—The number of large snags per acre for the two scenarios.

1.2.4 Outputs For Wildlife Managers and Silviculturists

Percent canopy cover for each of the scenarios is shown in figure 1.6. Wildlife habitat managers and silviculturists use this variable to evaluate management alternatives. Thomas and others (1979) say that 70 percent canopy cover is an important level with respect to deer and elk habitat needs. While neither of the scenarios demonstrate 70 percent cover, it is clear that the *Wildfire only* scenario shows high cover values for the simulated period up to the wildfire of 2065. In contrast, the *With prescribed fire* scenario shows reduced canopy cover, leaving the stand relatively open for most of the simulation period.

Fire is a major disturbance agent and can change the successional pathways of forest stands. FVS classifies the successional stage at each time step into one of the classes shown in figure 1.7 (O'Hara and others 1998, Crookston and Stage 1999). In both scenarios, fire acted to modify succession on this stand. A third scenario, without any fire, showed that the stand would be classified an old forest in 250 years.

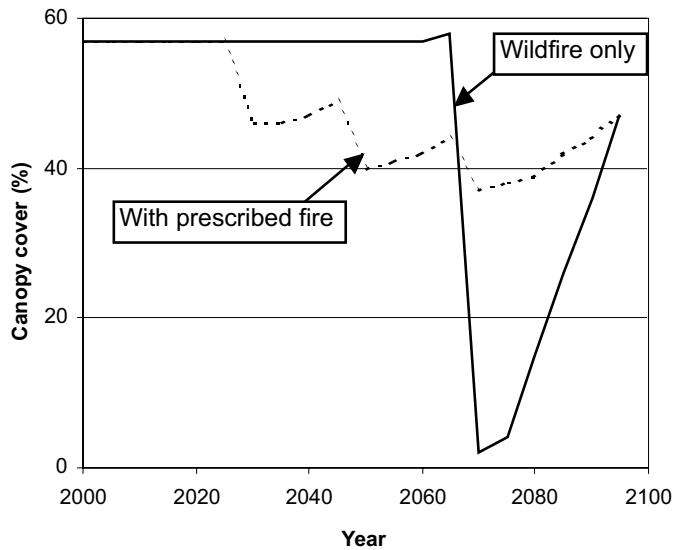

Figure 1.6—Canopy cover is a key variable used in habitat assessments. The prescribed fires caused a steady reduction of this variable while the *Wildfire only* scenario provided significant cover until the wildfire of 2065.

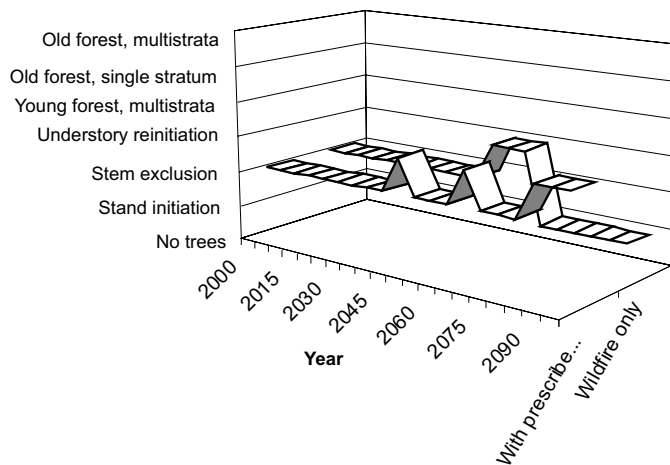

Figure 1.7—Stand structure is classified by FVS (Crookston and Stage 1999) and plotted here for each scenario. After the 2065 wildfire, the *With prescribed fire* scenario maintains later successional stages compared to *Wildfire only*.

1.2.5 Outputs for Silviculturists, Wildlife Managers, and Foresters

Top height (fig. 1.8) and volume (fig. 1.9) are key indicators for silviculturists and foresters. The simulations show that the average height of the largest trees is not greatly affected under the *With prescribed fire* scenario. The sequence of prescribed fires protects this vertical component of the stand from destruction by the wildfire of 2065. On the other hand, the prescribed fires cause a great deal of mortality and reduction in stocking resulting in a great loss in timber production. A plot of cubic volume over time (fig. 1.9) shows the model's ability to integrate growth, mortality, and fire processes showing how these processes affect productivity. There is no doubt that the *Wildfire only* scenario leads to the destruction of the timber in this stand in the 2065 wildfire while the *With prescribed fire* scenario left the stand capable of escaping the complete loss of timber.

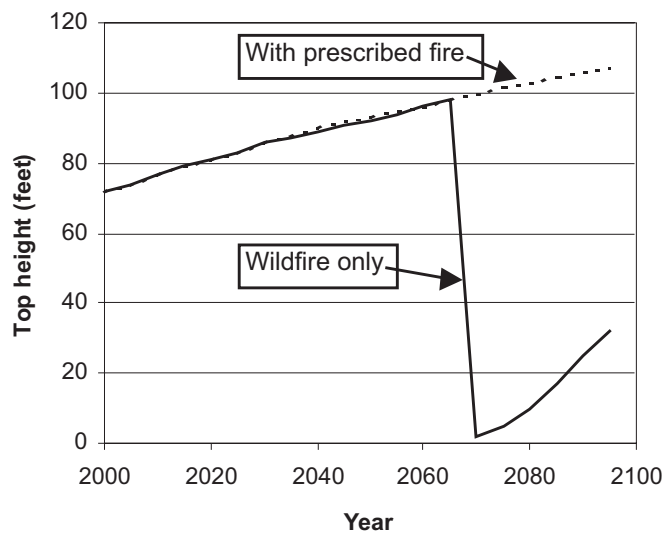

Figure 1.8—Top height is the average height of the largest 40 trees per acre. The scenarios provide similar top heights until the wildfire.

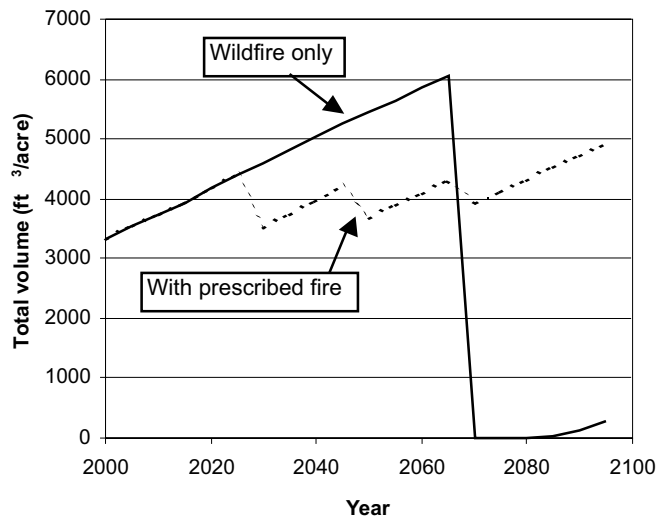

Figure 1.9—The series of prescribed fires seriously reduced timber production as seen by this graph of cubic volume over time; this trend is similar when board foot volume over time is plotted.

1.2.6 Summary of the Example

Structure, function, and composition of forest stands can be assessed for each management alternative using FFE-FVS. The base FVS model and the FFE calculate many variables besides those shown in figures 1.1 through 1.9. The dynamic interactions between the model components are evident.

Different, perhaps better, management options could be run as well. The FFE-FVS system provides several options to manage the trees, snags, and simulate fuel treatments. The “User’s Guide” (chapter 3) lists them all.

1.3 Applications

The FFE-FVS has proven useful in several situations. The first involved the evaluation of fuel treatments in an urban forest interface zone near Coeur D’Alene, ID. Simulations demonstrated to the National Forest managers and interested members of the public that post thinning fuel treatments were needed in addition to proposed thinning to meet fire hazard reduction goals. The simulation period was a few decades, and the analysis was done at the stand level.

Later, FFE-FVS was used to evaluate alternatives for managing forests and fuels in the wake of a Douglas-fir beetle outbreak on the Idaho Panhandle National Forests. The model was used to show the changes in potential flame length (using such figures as fig. 1.2) given different infestation and management scenarios, over a 150-year simulation period. The analysis was done in support of an environmental impact statement prepared while deciding what actions should be taken in response to the outbreak (IPNF 1999). How the outbreak affected long-term fuel loading and subsequent fire intensity was a key question. The results of the analysis were used to support a related environmental assessment (IPNF 2001).

During the summer 2000 fire season, FFE-FVS was used to confirm satellite-based data to predict future fire perimeter. Fire managers were using the spatially explicit model, FARSITE (Finney 1998), to predict fire spread. The FFE-FVS choice of fire behavior fuel model and estimates of canopy base height and bulk density were used to provide inputs to FARSITE. This application had a large spatial scope and 1-year time horizon. Since 2000, FFE-FVS has often been used as a step in generating fuel maps for use in FARSITE and, more recently, FlamMap (Hayes and others, in review).

The Northern Region of the Forest Service (Atkins and Lundberg 2002) used FFE-FVS to characterize forest structure, fuel loads, potential fire hazard, and forest health conditions in Montana. The analysis units are the Forest Inventory Analysis (FIA) plots on public and private lands. The work will be extended to Utah.

Christensen and others (2002) used the FFE-FVS to determine the effectiveness of several stand treatment options designed to reduce fire hazard both now and into the future. Long-term effects are reported in terms of the stocking, size, and species mix of stands and the size and species mix of trees and logs that might be removed for wood products.

FFE-FVS, coupled with SVS, was used to build the “Living with Fire” educational computer game intended for use by the general public. The game Web site is: http://www.fs.fed.us/rm/fire_game.

FFE-FVS is part of Prognosis EI (Greenough and others 1999), a detailed watershed-level environmental indicators model developed and used in

British Columbia. It is capable of representing several disturbance agents besides fire, represents the dynamic interactions of agents in space within the landscape, and directly outputs or links to scores of indicators measuring stand structural attributes, species-specific wildlife habitat quality for birds, bats, ungulates, and bears, patch size, old growth, 23 measures of water quality, visual quality, and timber. It is based on the Parallel Processing Extension of FVS (Crookston and Stage 1991), western root disease model (Frankel 1998), and is linked to a geographic information system. Its spatial scope is several thousand stands, and its time scope is over one generation of trees, about 300 years.

1.4 Conclusions

FFE-FVS is a rich model that provides outputs of interest to several disciplines, has been successfully used in a number of applications, and can be linked to other models and tools. The science on which it is based and its limitations are the subjects of the next paper in this volume. A user's guide follows outlining how to apply it to your needs. Differences between regional variants are outlined in the fourth paper.

Sarah J. Beukema
Elizabeth D. Reinhardt
Julee A. Greenough
Donald C. E. Robinson
Werner A. Kurz



Chapter 2

Fire and Fuels

Extension: Model Description

Abstract—The Fire and Fuels Extension to the Forest Vegetation Simulator is a model that simulates fuel dynamics and potential fire behavior over time, in the context of stand development and management. Existing models are used to represent forest stand development (the Forest Vegetation Simulator, Wykoff and others 1982), fire behavior (Rothermel 1972, Van Wagner 1977, and Scott and Reinhardt 2001), and fire effects (Reinhardt and others 1997). These models are linked together with newly developed models of snag and fuel dynamics. Users can simulate fuel treatments including prescribed fire, thinning, and mechanical treatments. Wildland fires can also be modeled. Model output includes predicted fuel loadings over time, and measures of fire hazard including potential flame length, canopy base height and canopy bulk density, torching and crowning indices and potential stand mortality over the simulation period. If a prescribed fire or wildland fire is simulated, output also includes predicted fire behavior, fuel consumption, smoke production, and tree mortality.

Keywords: fire behavior, fire effects, stand dynamics, silviculture, fuel treatment, prescribed fire, potential wildfire behavior, fuel dynamics

2.1 Introduction

The Forest Vegetation Simulator (FVS) (Stage 1973; Wykoff and others 1982) is used by forest managers throughout the United States and Canada to predict stand dynamics and the effects of various management actions on future forest conditions. It is an individual tree, distance-independent growth and yield model. The role of fire in ecosystem dynamics has not previously been explicitly represented in FVS. Other models have been

developed to represent fuel dynamics with and without fire (Keane and others 1989), fire behavior (Albini 1976a,b; Rothermel 1972), and fire effects (Reinhardt and others 1997). These models, however, do not address the dynamics of vegetation management.

We developed the Fire and Fuels Extension to FVS (FFE-FVS) by integrating FVS with elements from existing models of fire behavior and fire effects. FFE-FVS predicts changes in stand and fuel characteristics over time and the behavior and impacts of fire. The model is not intended to predict the probability of fire or the spread of fire between stands.

The FVS simulates tree growth, tree mortality and regeneration, and the impacts of a wide range of silvicultural treatments. The Fire and Fuels Extension simulates fuel accumulation from stand dynamics and management activities, and the removal of fuel through decay, mechanical treatments and prescribed or wildfires. Various types of fuel are represented, including canopy fuel and surface fuel in several diameter classes. Fire behavior and fire effects such as fuel consumption, tree mortality, and smoke production are modeled. Model output describes fuel characteristics, stand structure, snags, and potential fire behavior over time and provides a basis for comparing proposed fuel treatments.

Where possible, FFE-FVS uses existing models and algorithms to simulate fires. To predict fire intensity, it uses Rothermel's fire behavior model as implemented by Albini (1976a) in FIREMOD and subsequently by Andrews (1986) in Behave. The onset of crowning is predicted using approaches developed by Van Wagner (1977) and Scott and Reinhardt (2001). The model uses methods from FOFEM (Reinhardt and others 1997) for predicting tree mortality, fuel consumption and smoke production. Methods for simulating fuel accumulation and decay and snag dynamics were developed for FFE-FVS using information described in detail in sections 2.3 and 2.4 of this chapter.

The model does not simulate fire spread or the probability of fire. It calculates *potential* fire intensity over time, under user-defined conditions, as a measure of the fire hazard of stand and fuel conditions. It also allows the user to schedule or simulate a fire or series of fires at given points in time or when certain stand conditions are reached. When a fire is simulated, the model computes its intensity, its effects on different stand components, and the associated emissions.

This chapter describes the model processes and assumptions in detail for the northern Idaho variant. Details about other variants are given in chapter 4.

Examples of FFE-FVS output in this chapter use the same example stand as does chapter 1: a Douglas-fir stand in western Montana that is burned with a wildfire in 2065.

2.2 Model Structure

The Fire and Fuels Extension includes three major submodels:

1. A snag model for tracking and simulating decay and fall down of standing dead trees.
2. A fuel model that simulates the accumulation (through litterfall and other sources) and decomposition of surface fuel, tracks canopy fuel characteristics, and selects fire behavior fuel models.
3. A fire model that simulates fire intensity and fire effects on trees, snags, and fuel as well as smoke production and mineral soil exposure.

As with all of FVS, users interact with the FFE using keywords specific to FVS and to FFE. Once the FFE is invoked, the snag and fuel components are automatically present. Users can simulate fires or request fuel treatments using keywords. Many FFE-specific characteristics are linked to the Event Monitor (Crookston 1990). This allows users to request the simulation of events or management actions, such as fuel treatment, if certain stand or fuel conditions are predicted by the model.

FVS passes control to the FFE in every growth cycle (fig. 2.1). The FFE operates on an annual time step within the FVS cycle (normally representing 5- or 10-year time steps). All simulation results relevant to FVS, such as fire effects on tree mortality, are passed back to FVS at the end of the cycle. Figure 2.2 illustrates the general scheme of the FFE-FVS. FVS uses a tree list to represent a stand. For each tree in the list, FVS stores several attributes including dbh, height, crown length, and the number of trees per acre represented by the sample tree. Similarly, the FFE tracks snags using a snag list, which carries attributes specific to snags (see section 2.3.1). Snags are created through mortality and gradually break apart and fall, thus contributing to the surface fuel.

Fuel is tracked in a number of fuel pools (section 2.4.1) representing the quantity of fuel in different size classes. Fuel pools can be initialized by the user, or the FFE will estimate initial loadings from the tree list and habitat

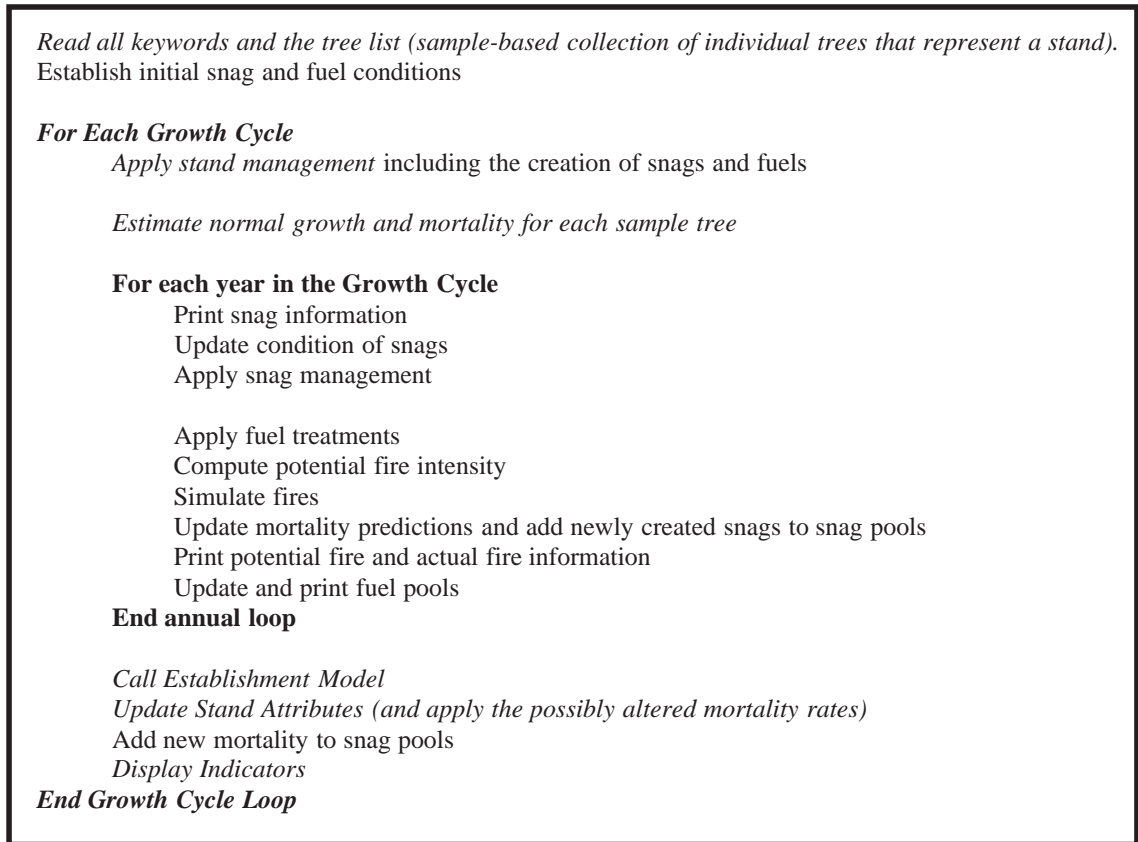

Figure 2.1—Order of calculations in the FFE, including sections of FVS. Italicized activities are part of FVS.

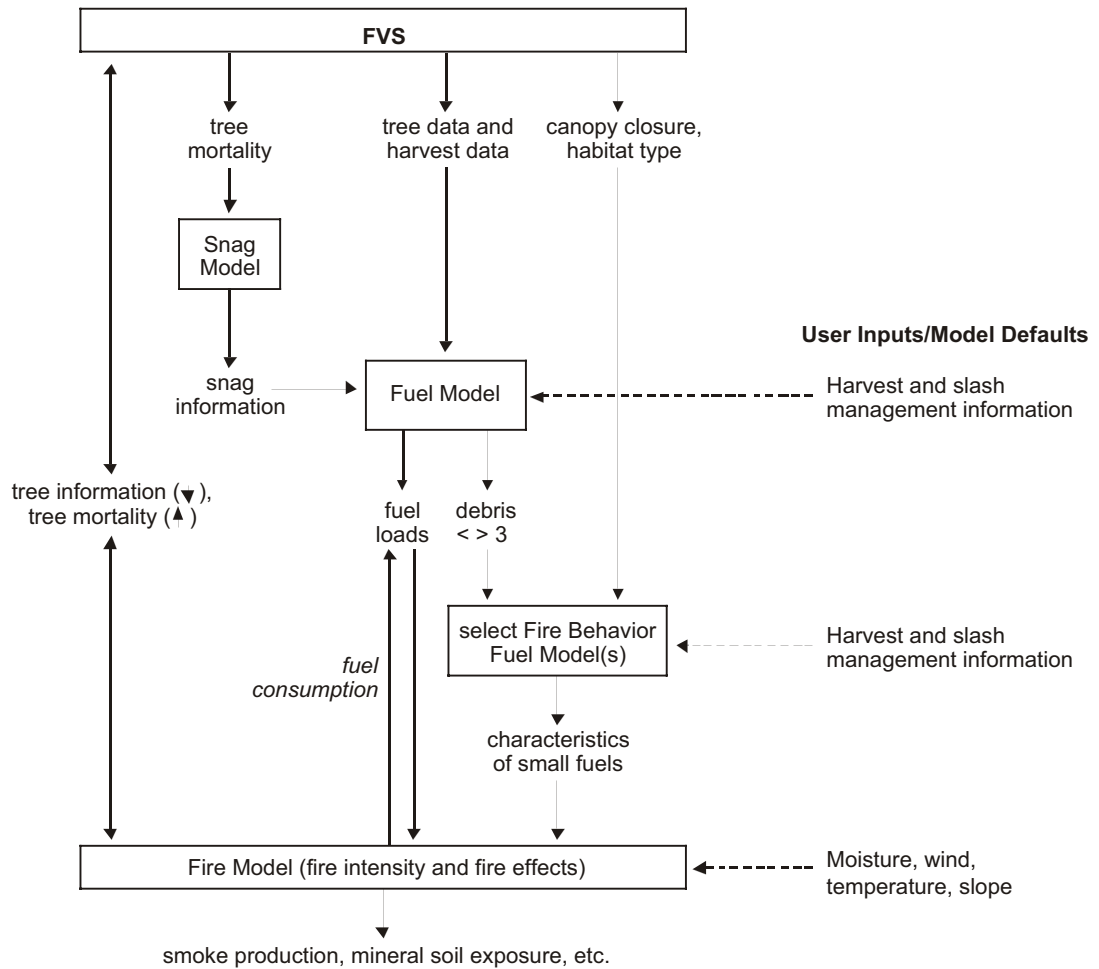

Figure 2.2—Scheme of the FFE-FVS Model. The boxes in this figure show the major submodels of the FFE. Arrows indicate the flow of information between submodels. See text for further explanation.

type. The fuel pools are updated on an annual timestep by simulating input and decomposition, as well as movement from one pool to another. The simulated fuel loadings, along with the habitat type and management history of the stand, are used to select one or more fire behavior fuel models (Anderson 1982) that most closely represent fuel conditions (section 2.4.8). These fire behavior fuel models are used to predict fire behavior rather than the simulated fuel loadings because of the extreme sensitivity of the fire behavior model to fuel parameters we cannot easily track in the FFE, in particular surface area to volume ratio and fuel bed depth.

Surface fire intensity is predicted using Rothermel’s model (Rothermel 1972; Albini 1976a) for each of the selected fire behavior fuel models. The predicted fire behavior for the models is then combined in a weighted average (section 2.5.4). The weighted average and canopy fuel characteristics are used to determine whether crown fire occurs. Fire intensity, expressed as flame length, and degree of crowning (surface, passive or active) are used as indicators of the fire hazard of the fuel and stand conditions. They are also used to calculate the effects of a simulated fire (that is, fuel consumption, smoke production, tree mortality, mineral soil exposure, and so forth; see section 2.5.5).

2.3 Snag Submodel

2.3.1 Overview

The snag submodel tracks the breakage, decay and fall-down of the boles of standing dead trees. The term “snag” throughout is used only to refer to *standing* dead trees; once they have fallen, they are modeled as surface fuel. The foliage and branches of snags also fall and contribute to surface fuel, as described in section 2.4.4.

Snags are represented in the model using a snag list. Each list element, called a snag record, represents a group or class of snags. These are snags of the same species, that died in the same simulation cycle or year, and that are in the same diameter and height class. The snags in each record are described by the following characteristics:

- Diameter class—Snags are grouped into 2-inch diameter classes, based on their dbh at the time of death. The largest class represents all snags with a dbh of 36 inches or more.
- Species—Tree species.
- Height at death—Average height of the trees in that record at the time of death (for the initially hard and initially soft snags separately; see item 6 below). If the height of otherwise similar trees differs by more than 20 feet, two records are created (section 2.3.3). This allows the model to follow these height differences in the simulation of snag dynamics.
- Current height—Average current height of the snags in the record, again for initially hard and initially soft snags separately. The height will decrease over time as the snags start to break apart (section 2.3.4).
- Years since death—Number of years since the death of the tree (that is, the time since the snag was created).
- Decay status—Decay status: hard or soft. Soft snags are more decayed and are assumed to have 80 percent of the wood density of hard snags.
- Density—Number of stems per acre represented by this record. This will decrease as snags of this record start to fall down (section 2.3.6).

Only four of the characteristics will change over time (current height, years since death, decay status, and density). The simulated change in height as snags age allows the corresponding reduction in volume to be calculated (using the diameter at time of death).

2.3.2 Initialization

Snags can be initialized in the model using two options. Snags can be included in the input FVS tree list along with live trees by recording the species, dbh, and height information and a code indicating that the tree is dead. At present, all trees initialized in this manner are assumed to have died 5 years before the inventory year. The model does not use the FVS tree list codes that describe snag age. By default, these snags are hard, but the **SNAGPSFT** keyword can be used to change this assumption.

Snag records can also be created using the **SNAGINIT** keyword. Each of the snag characteristics described above, except decay status, can be defined using this keyword. These snags are also assumed to be hard, unless the user has changed the default using the **SNAGPSFT** keyword.

During a model simulation, snags may be created through FVS-predicted natural mortality (every simulation cycle), fire-caused mortality (in the year of fire) (see section 2.5.5), and some management actions (see section 2.3.7).

2.3.3 Creation and Maintenance of Snag Records

The model uses snag records to represent groups of snags that die in the same simulation cycle or year, belong to the same species, dbh class, and are within a 20-foot height range. When new snags are created, the model determines the height range of snags of the same species and dbh class. If height varies by more than 20 feet, two records are created for snags of that species and dbh class. Thus, some of the variability in initial snag heights is maintained in the model. In all cases, the density-weighted average height and average dbh of all the snags in each record are used as the attributes.

Snag records are eliminated once all snags in the record have fallen (section 2.3.6), when the record contains fewer than 0.0002 snags per acre (equivalent to 1/100th of one snag in a 50 acre stand), or when the current height of the snags in the record is less than 1.5 feet. Any remaining snag material in these records is added to the surface fuel with the other fallen snags.

Currently the number of snag records in the FFE is limited to 2,000. If a new snag record is needed and all of the snag records are already in use, then the model must search for a snag record to overwrite. The model first searches the snag records created in all previous years to determine which contains the fewest snags. If this record contains fewer snags than the new record would have if all the new snags were in the same height group, then the existing snags are knocked over and the record is used by the new snags. If not, then the model determines which snag record already created this year has the fewest snags. Again, if this record contains fewer snags than the new record would have, the snags are felled and the new snags are used instead. If at this point no record has been found for the new snags, then these snags are placed on the ground. The activity summary will report whenever snags are moved to the surface fuel pools in this manner.

2.3.4 Height Loss

As snags age, their tops break off and fall to the ground, decreasing the snag height. In the model, this process slows with time, as the remaining top of the tree becomes wider at each successive breakpoint. We assume breakage occurs at a faster rate until half of the initial height has been lost, then occurs at a slower rate. All species use the same pattern of breakage, but the rates differ between them (fig. 2.3). In addition, initially soft snags lose height twice as quickly as initially hard snags. This difference in height loss is under user control.

The basic equations for snag breakage are:

$$HT_t = HT_0(1 - 0.0228mx)^t \quad \text{if}(1-0.0228mx)^t > 0.5$$

$$HT_t = 0.5HT_0(1 - 0.01mx)^{t-y} \quad \text{if}(1-0.0228mx)^t \leq 0.5$$

where:

- t = number of years since death;
- y = number of years after death when half of the initial height has been lost;

HT_t = height of the snag at t years after death;
 HT_0 = height of the snag at death;
 m = multiplier used to change the base rate for different species; and
 x = multiplier used to accelerate the rate of breakage of initially soft snags (default values are $x=1$ for initially hard snags, and $x=2$ for initially soft snags).

These equations are defined such that, with $m=1$, snags lose 2.28 percent of their current height each year until they have lost 50 percent of their original height in about 30 years. After that, the remaining breakage occurs at a rate of 1 percent per year. The switch from the faster rate to the slower rate occurs when 50 percent of the initial height of the snag has been lost (table 2.1).

Snags are considered surface fuel if they are less than 1.5 feet in height. At this point, the amount of material represented by the remaining bole is transferred to the appropriate surface fuel pools and the record is eliminated from the snag list.

Using the **SNAGBRK** keyword, users can control the breakage rates for each species by defining the time it takes for a given amount to break. The model translates these times into the parameter m .

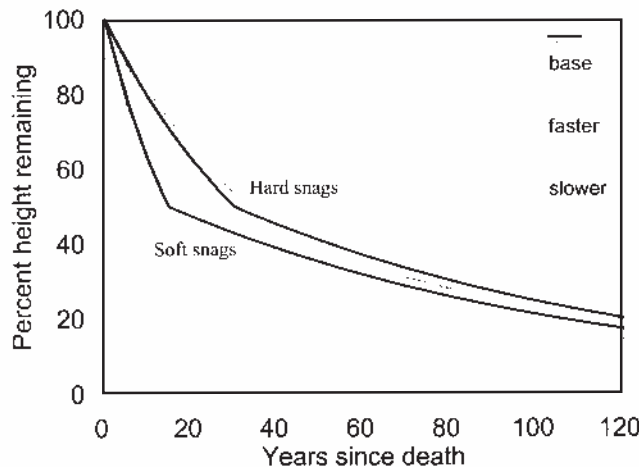

Figure 2.3—Comparison between patterns of height loss for initially hard or soft snags with the three different sets of default rates.

Table 2.1—Comparison between height loss for different species. The “Years to 50 percent height loss” is the number of years after death required for 50 percent of the original height to be lost. This is the time at which the simulated breakage rate switches from the faster rate (for example, 2.28 percent) to the slower rate (for example, 1 percent). The “Multiplier” is the value used by default on the initially defined percentages. The “% of height after 100 years” gives the percent of the initial height that is still remaining on standing snags after 100 years.

	Species	Multiplier	Years to 50% height loss		% of Height after 100 years	
			Hard	Soft	Hard	Soft
Base	Ponderosa pine, Other	1.0	30	14	25	21
Faster	Grand fir, Western hemlock, Cedar, Lodgepole pine, Spruce, Subalpine fir	1.1	27	13	22	19
Slower	White pine, Larch, Douglas-fir	0.9	33	16	27	2

2.3.5 Decay

Decay is the process by which snags become softer. In the snag model, there are only two stages of decay: hard and soft. Newly created snags are classified as “hard” in the model, unless otherwise specified by the user. Over time, these snags decay until eventually they are considered “soft”. Soft snags experience more rapid height loss in the model (section 2.3.4). Debris originating from soft snags decays faster than debris from hard snags (section 2.4.5).

All hard snags, assuming that they remain standing, will eventually become soft snags. The rate of this decay depends on the diameter of the tree at the time of death and its species. The basic decay rate is based on a linear approximation of some rates for Douglas-fir (Bruce Marcot, USFS, Portland, OR, unpubl. data, 1995), and has the form:

$$DecayTime = m(1.24dbh + 13.82)$$

where:

DecayTime = number of years it takes for a hard snag to become soft (that is, the time from death to transition to soft);

dbh = dbh (in inches) of the snag at the time of death; and

m = multiplier used to scale the equation to increase or decrease the decay rate for different species.

The default decay rate of each species is assigned using a scaling multiplier of 0.9, 1.0, or 1.1 (fig. 2.4). The scaling value, *m*, used for each species can be changed using the **SNAGDCAY** keyword.

2.3.6 Falldown

Standing snags will eventually fall. In the model, fall rates vary based on species, size, and whether the snag was present during a fire. With one exception, the rates do not depend on snag age or decay status. As with the breakage and decay rates, a basic set of rates is defined. These rates are based

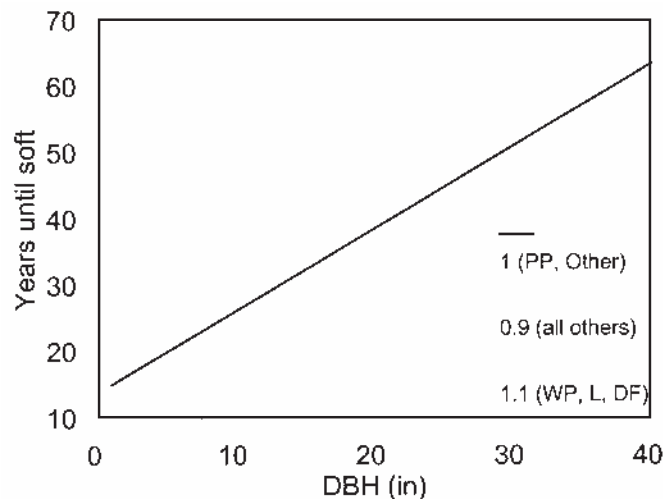

Figure 2.4—Number of years until decay for the different default rates and a range of dbh. A multiplier less than 1 decreases the amount of time until decay (that is, the snag decays faster) while multipliers greater than 1 increase the amount of time before decay (that is, the snag decays slower).

on a linear approximation of data for ponderosa pine snags (Bruce Marcot, USFS, Portland, OR, unpubl. data, 1995), with a modification to ensure that some large snags remain standing for 100 years.

For all snags less than 18 inches, and for all but the last 5 percent of snags over 18 inches, the number of snags in a record that fall each year is calculated as:

$$R = -0.001679d + 0.064311$$

$$F = mRN_0$$

where:

R = rate of fall (fig. 2.5); for records with a dbh greater than 32.3 inches, this rate is set to 0.01;

d = initial dbh of the snag, in inches;

N_0 = initial density (stems/acre) of snags in the record;

m = multiplier that can be used to change the rate of fall; and

F = density of snags (stems/acre) that fall each year from that record.

For the last 5 percent of snags over 18 inches, the number of snags falling each year is:

$$F = \frac{0.05}{A - T} N_0$$

where:

F = density of snags (stems/acre) that fall each year from that record;

A = maximum number of years that snags will remain standing (that is, the time when all snags will have fallen);

T = time when 95 percent of the snags had fallen; and

N_0 = initial density of snags (stems per acre) in the record.

This is the only exception to the rule that the fall rates do not depend on age. This equation ensures that some large snags persist throughout the period of time A , but that none persist beyond this time. By default,

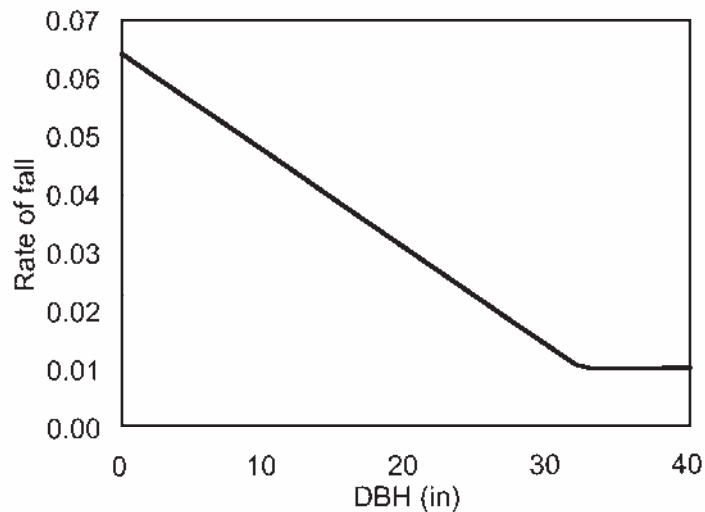

Figure 2.5—The rate of fall of small snags and the first 95 percent of large snags.

ponderosa pine snags fall at the rate calculated with $m=1$ and with a maximum persistence time of 100 years for snags over 18 inches. All other species are assumed to fall either 10 percent faster or 10 percent slower. Similarly, the maximum persistence time for snags over 18 inches is also assumed to be either 10 percent longer, or 10 percent shorter (table 2.2). Figure 2.6 compares the effect of the three fall rates for large and small snags. The user can specify both the normal fall-rate multiplier m and the persistence time A for each species using the keyword **SNAGFALL**.

Fires that exceed a threshold scorch height (by default 0 ft) increase the fall rates of previously existing soft snags and small snags (fig. 2.7). After a fire, all soft snags and 90 percent of hard snags smaller than 12 inches dbh will fall within 7 years. Snags that would already fall in less than 7 years will still fall at their “preburn” rate. Large, hard snags are unaffected by fires. These parameters may all be controlled by the user using the keyword **SNAGPBN**.

Table 2.2—Default snag fall rate modifiers for different species. Ponderosa pine is the base species. Species that are assumed to fall faster have a higher multiplier and a shorter maximum persistence time. The opposite is true for the species with slower falling snags. Species “other” was assigned the base rate values because it is not known which species will be included in “other.”

	Species	Multiplier (m)	Maximum Persistence Time (years, A)
Base	Ponderosa pine, Other	1.0	100
Faster	Grand fir, Western hemlock, Cedar, Lodgepole pine, Spruce, Subalpine fir	1.1	90
Slower	White pine, Larch, Douglas-fir	0.9	110

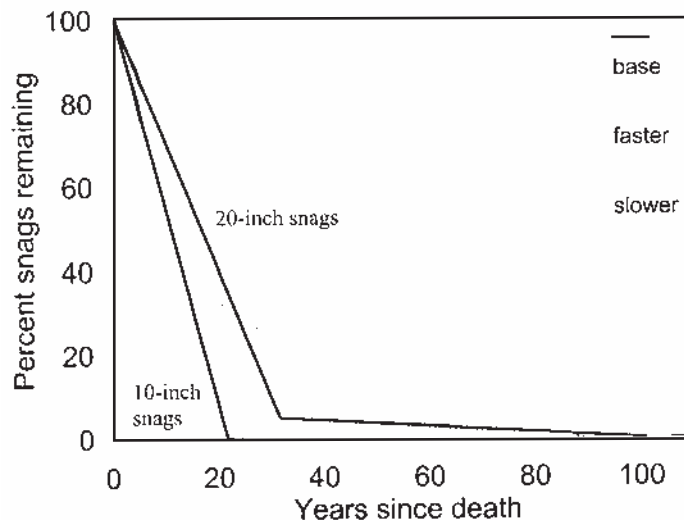

Figure 2.6—Percent of large and small snags standing as a function of years since death. The last 5 percent of large snags, or those greater than 18" dbh, remain for a long period of time, while small snags fall at a constant rate. Fall rates decrease with increasing dbh and differ between species (see table 2.2).

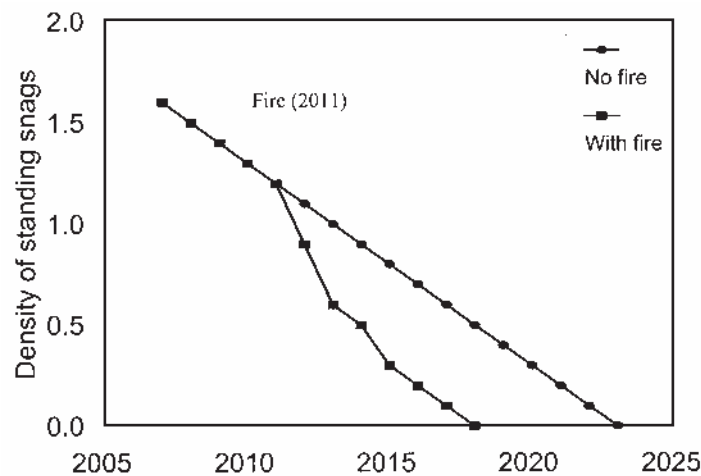

Figure 2.7—Effect of fire on the fall rate of a sample snag record. The example record contains 6.8 inch GF snags that were created in 2006. The graph shows the density of the snags with and without a fire in 2011.

2.3.7 Management

Snags can be created by simulating thinning using base FVS model keywords and requesting that all (or a portion) of the thinned trees be left standing. This request can be specified with the **YARDLOSS** keyword.

Snag removal is simulated using the FFE keyword **SALVAGE**. Users can select snags to salvage based on time since death, size (dbh at death), and decay status (hard/soft). Salvage operates after base model management options and after the snag dynamics (falling, breakage, and so forth) have been applied but before fires are simulated. Thus, if a user specifies that all new snags be removed, any snags created using the **YARDLOSS** keyword in the current year will be eligible for removal, but those created from a fire in the current year have not yet been produced, and cannot be salvaged.

Note that the FFE **SALVAGE** keyword is different from the base model **SALVAGE** keyword. The FFE keyword removes snags from the snag list maintained by the FFE while the base model version acts on the main FVS tree list.

The amount of the salvage is printed in two places: as the last field in the activity summary (volume/acre removed), and in the column “standing removed” in the detailed fuel report (tons removed; section 2.4.10). The size and species distribution of the salvage can also be inferred to some degree through changes in snags reported in the detailed snag output report (section 2.3.8). No more detailed breakdown of salvage amounts is currently available.

2.3.8 Output

Information about snags in the model can be important for determining wildlife values or other nontimber indicators. Two snag output reports – detailed or summary – can be produced by the model.

Detailed Snag Report: The detailed snag report produces information about snags at user-requested intervals or years (**SNAGOUT** keyword). It is printed at the beginning of the year, after base model harvesting (which could create snags) but before any other FFE operations such as snag dynamics, salvage logging, or fires. The report summarizes the snag records by species

into up to six user-defined diameter size classes. The report provides the following information on these summary records (table 2.3):

Year	The simulation year of the report.
Species	The two-letter species code of the species being reported.
DBH cl	A value from 1 to 6, indicating the user defined size class of snags in this record.
Death dbh	The average diameter (inches), at the time of death, of the snags that are aggregated into this record.
Curr height (ft)	
Hard	The average height of currently hard snags aggregated into this record.
Soft	The average height of currently soft snags aggregated into this record.
Curr volume (ft ³ /acre)	This volume is estimated from the original height of the snags, the current height, and the diameter at the time of death.
Hard	The volume of currently hard snags.
Soft	The volume of currently soft snags.
Total	Sum of hard and soft volumes.
Year died	The year the record was created (the year that the tree died).
Density	Number of snags/acre
Hard	
Soft	
Total	

Table 2.3—Example detailed snag report. In this example, snags were only reported for the year 2008. The stand contains hard Douglas-fir (DF), larch (L) and lodgepole pine (LP) snags that had died in 2004 and 1999, as well as some soft lodgepole snags that had died in 1983.

ESTIMATED SNAG CHARACTERISTICS, STAND ID=300290024601

YEAR	SP	CL	DEATH DBH (IN)		CURR HEIGHT (FT)		CURR VOLUME (FT ³)			YEAR DIED	DENSITY (#/ACRE)		
			DBH	CL	HARD	SOFT	HARD	SOFT	TOTAL		HARD	SOFT	TOTAL
2008	L	1	2.0	2.0	22.0	0.0	0	0	0	2004	5.4	0.0	5.4
2008	DF	1	4.8	4.8	35.8	0.0	55	0	55	2004	17.7	0.0	17.7
2008	DF	2	13.5	13.5	72.3	0.0	2	0	2	2004	0.1	0.0	0.1
2008	DF	3	21.0	21.0	79.3	0.0	6	0	6	2004	0.1	0.0	0.1
2008	DF	6	38.1	38.1	92.5	0.0	2	0	2	2004	0.0	0.0	0.0
2008	LP	1	6.4	6.4	64.1	0.0	25	0	25	2004	3.1	0.0	3.1
2008	L	1	1.8	1.8	18.6	0.0	0	0	0	1999	6.4	0.0	6.4
2008	DF	1	4.4	4.4	29.5	0.0	53	0	53	1999	21.4	0.0	21.4
2008	DF	2	13.4	13.4	62.7	0.0	2	0	2	1999	0.1	0.0	0.1
2008	DF	3	20.6	20.6	69.5	0.0	7	0	7	1999	0.1	0.0	0.1
2008	DF	6	37.9	37.9	82.2	0.0	2	0	2	1999	0.0	0.0	0.0
2008	LP	1	6.1	6.1	54.5	0.0	28	0	28	1999	4.1	0.0	4.1
2008	LP	1	6.9	6.9	0.0	41.2	0	257	257	1983	0.0	33.8	33.8

The default size class boundaries for reporting are, in inches, at 12, 18, 24, 30, 36, and greater than 36 inches dbh at death. These values can be changed with the **SNAGCLS** keyword. The report lists only species and size classes that are present in the reporting year. Classes with low densities (less than 0.05 trees/acre) show densities of .0 in this report.

Each line in the report may represent more than one snag record because for reporting purposes snags are grouped into larger diameter size classes. Within each class, all reported values are averages of the characteristics of each snag record. This averaging means that some reported values may change between years in a counterintuitive fashion as records within the class lose height or numbers at different rates. Table 2.4 shows a selection of output for Douglas-fir snags that were created in 1996 and that are in the first dbh class. Although the dbh of a particular snag record does not change during the simulation, the average dbh and height in the reported class increases over time because the smaller snag records included in the class fall faster (and thus contribute less to the average) than the larger snag records in the reporting class.

Snag records can be created at harvesting, after a fire, or from natural mortality applied at cycle boundaries. They can only be removed through falling or salvage. If the detailed snag report is printed every year (and the cycle length is longer than a year), there will be slight regular changes from height-loss and falling. Dramatic changes such as fire mortality or salvage should be relatively easy to distinguish. Any newly created snags should correspond to other reports: the fire mortality information (section 2.5.7) or the distribution of harvested trees from the base model.

Summary Snag Report: The detailed snag report contains a large amount of information typically required only for detailed analyses. A summary snag report can be requested using the keyword **SNAGSUM**. It is printed at the beginning of the last year of every cycle and contains the total density of snags that are larger than the given diameter. In table 2.5 for example, the first column lists all snags, the second column gives the density of all snags greater than 12 inches diameter, and so forth. With the exception of a distinction between hard and soft snags, this table contains no other

Table 2.4—Sample output from the detailed snag report showing a selection of reports about size class 1 Douglas-fir that died in 1996. Death dbh is the average dbh of snags combined in a given record.

Year	Sp.	Dbh cls	Death dbh	Height		Total Volume			Year Dead	Density		
				hard	soft	hard	soft	total		hard	soft	Total
2009	DF	1	0.9	7.2	0.0	4.0	0	4.0	1996	19.51	0.00	19.15
2010	DF	1	1.0	7.2	0.0	3.5	0	3.5	1996	15.33	0.00	15.33
2011	DF	1	1.0	7.3	0.0	2.9	0	2.9	1996	11.15	0.00	11.15
2012	DF	1	1.2	19.1	4.7	2.3	0	2.3	1996	1.48	5.50	6.97
2013	DF	1	1.7	19.5	4.6	1.8	0	1.8	1996	0.97	1.82	2.79
2014	DF	1	4.6	21.3	0.0	1.3	0	1.3	1996	0.46	0.00	0.46
2015	DF	1	7.4	31.4	0.0	0.9	0	0.9	1996	0.12	0.00	0.12
2016	DF	1	10.5	46.2	0.0	0.6	0	0.6	1996	0.05	0.00	0.05

Table 2.5—Example output from the summary snag report. In this example, most snags are hard, but some soft snags appear briefly in 2005 through 2010. These snags were previously hard (note the sharp decline in hard snags between 2000 and 2005). Each column of each snag type also contains the snags in the larger size classes to the right. Thus, in 2070, there are 163.2 snags/acre total (greater than 0"), of which 4.1 snags/acre are $\geq 12"$. Throughout the simulation, most of the snags are small ($< 12"$), however, the 2070 wildfire killed a number of larger trees. These do not show up till 2075 because the snag report is written before fire is simulated.

----- SNAG SUMMARY REPORT -----												
YEAR	HARD SNAGS/ACRE						SOFT SNAGS/ACRE					
	$\geq 0"$	$\geq 12"$	$\geq 18"$	$\geq 24"$	$\geq 30"$	$\geq 36"$	$\geq 0"$	$\geq 12"$	$\geq 18"$	$\geq 24"$	$\geq 30"$	$\geq 36"$
1993	270.0	0.0	0.0	0.0	0.0	0.0	0.0	0.0	0.0	0.0	0.0	0.0
2000	215.5	0.3	0.2	0.0	0.0	0.0	0.0	0.0	0.0	0.0	0.0	0.0
2005	80.4	0.5	0.3	0.0	0.0	0.0	72.8	0.0	0.0	0.0	0.0	0.0
2010	79.2	0.8	0.3	0.0	0.0	0.0	3.4	0.0	0.0	0.0	0.0	0.0
2015	74.9	1.1	0.4	0.0	0.0	0.0	0.0	0.0	0.0	0.0	0.0	0.0
2020	149.3	1.3	0.4	0.0	0.0	0.0	0.0	0.0	0.0	0.0	0.0	0.0
2025	126.2	1.7	0.5	0.0	0.0	0.0	0.0	0.0	0.0	0.0	0.0	0.0
2030	109.5	2.1	0.5	0.1	0.1	0.1	0.0	0.0	0.0	0.0	0.0	0.0
2035	119.5	2.6	0.5	0.1	0.1	0.1	0.0	0.0	0.0	0.0	0.0	0.0
2040	173.1	2.7	0.5	0.1	0.1	0.1	0.0	0.0	0.0	0.0	0.0	0.0
2045	184.2	2.9	0.5	0.1	0.1	0.1	0.0	0.0	0.0	0.0	0.0	0.0
2050	155.8	3.1	0.5	0.2	0.1	0.1	0.0	0.0	0.0	0.0	0.0	0.0
2055	138.4	3.4	0.5	0.2	0.1	0.1	0.0	0.0	0.0	0.0	0.0	0.0
2060	169.0	3.5	0.6	0.2	0.1	0.1	0.0	0.0	0.0	0.0	0.0	0.0
2065	175.5	3.7	0.6	0.3	0.1	0.1	0.0	0.0	0.0	0.0	0.0	0.0
2070	163.2	4.1	0.7	0.3	0.1	0.1	0.0	0.0	0.0	0.0	0.0	0.0
2075	228.5	77.4	10.8	4.9	0.7	0.7	0.0	0.0	0.0	0.0	0.0	0.0
2080	76.1	61.5	9.4	4.4	0.6	0.6	0.0	0.0	0.0	0.0	0.0	0.0
2085	55.1	45.7	8.0	3.9	0.6	0.6	0.0	0.0	0.0	0.0	0.0	0.0
2090	44.3	30.1	6.6	3.5	0.6	0.6	0.0	0.0	0.0	0.0	0.0	0.0
2095	54.1	14.6	5.2	3.0	0.5	0.5	0.0	0.0	0.0	0.0	0.0	0.0

distinguishing information about species, heights, volumes, or age. The table has the format:

- Year
- Density of hard snags
 - diameter size class 1
 - diameter size class 2
 - etc.
- Density of soft snags
 - diameter size class 1
 - diameter size class 2
 - etc.

The sizes classes are the same ones that are used in the detailed snag output report and can be defined by the user with **SNAGCLS** keyword. If the detailed snag report and the summary snag report are both printed in the same year, the total densities reported in both tables should be the same.

2.4 Fuel Submodel

2.4.1 Overview

The fuel submodel accounts for the dynamics of all nonliving biomass derived from aboveground sources in the stand. It receives input from live trees (litterfall, crown lifting, and breakage), snags (either breaking up or

falling over), and harvest activity, (fig. 2.8) and simulates decay over time using a simple constant proportional loss model. Litter and six size classes of woody fuel are modeled (table 2.6). The fuel submodel simulates decay dynamics based on up to four species-dependent decay rates, and accounts for differences attributable to the hard or soft condition of the input from snag boles and snag material (table 2.6).

Some of the decaying material from the above classes moves into a duff pool. Duff does not use different species-dependent decay rates and, like litter, is not stratified as hard or soft. Thus, a single decay rate is used for all duff material.

The fuel submodel also tracks a nominal measure of live herbs and shrubs in the stand (see section 2.4.6).

Canopy fuel characteristics are tracked as indicators and for use in predicting fire behavior (section 2.4.7).

Surface fuel loads are important indicators. They are also used in the FFE to key to predefined fire behavior fuel models used for calculating fire intensity (section 2.4.8).

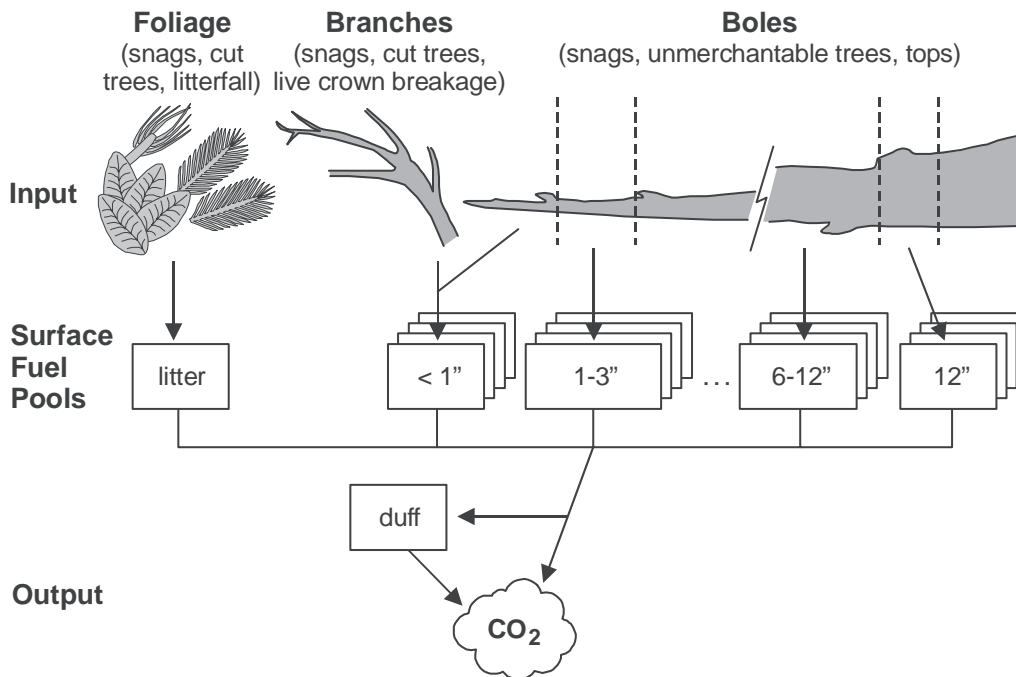

Figure 2.8—Flow of material within the fuel model. Material enters the various size classes, decays and goes either to the duff pool or to air (which is not tracked in this model). Not all size classes are shown in the figure. See table 2.6 for a complete list.

Table 2.6—Fuel pools may be characterized by a combination of the following attributes.

Size class	Fuel characteristics	
	Decay rate	Initial decay status
Litter	Very fast	Hard
diam <0.25"	Fast	Soft
0.25" ≤ diam < 1"	Slow	
1" ≤ diam <3"	Very slow	
3" ≤ diam < 6"		
6" ≤ diam < 12"		
diam ≥ 12"		

2.4.2 Initialization

Fuel loads can be initialized with the keyword **FUELINIT**. If the user does not specify initial fuel loads, the model sets them based on the dominant cover type in the stand and the percent cover (table 2.7; Jim Brown, pers. comm. 1995). When the model simulation is started from a tree list, the cover type is set to the species with the highest total basal area. If there are no trees in the stand, the cover type is defined as the major climax species in the stand's given habitat type (Cooper and others 1991; Pfister and others 1977), because those were likely the tree species that created the existing fuel pools. The rules and values used to determine default initial fuel loads by size class vary greatly between FVS variants.

The amount and distribution of fuel in an actual forest stand is highly dependent on the stand's history. For example, a stand generated after stand-replacing fire will have different fuel than one generated after a clear cut. This variation is not captured by the model's default initial values, so we recommend initializing fuel loadings to appropriate values rather than using model defaults whenever possible.

During a simulation, woody debris from each tree is assigned a fuel decay rate class based on species (table 2.8). At initialization, once the total amount of fuel in each size class has been established, it is apportioned between the various decay rate classes using the relative amounts of basal area of each tree species present in the stand. If there are no trees in the stand, all fuel is placed into the decay class corresponding to the cover type determined above. All initial fuel is assumed hard.

Table 2.7—Default initial fuel loadings (tons/acre), by size class, based on the cover type of the stand. If there are trees present at the time of initialization, values in row “E” (for “Established”) will be used, while if there are no trees (in other words, a bare ground simulation), the canopy cover is less than 10 percent, or all trees are smaller than 1” dbh, the values in row “I” (for “Initiating”) will be used. The 0-1” pool is divided equally between the smallest two classes (0-0.25” and 0.25-1”) (Jim Brown, pers. comm., 1995).

		Surface Fuel Size Class					Litter	Duff
		0-1"	1-3"	3-6"	6-12"	>12"		
Western White pine	E	1.0	0.8	10.0	10.0	10.0	0.8	30.0
	I	0.6	0.4	6.0	6.0	6.0	0.4	12.0
Douglas-fir, Western larch	E	0.9	0.8	3.5	3.5	0.0	0.6	10.0
	I	0.5	0.5	1.4	1.4	0.0	0.3	5.0
Grand fir	E	0.7	1.5	7.0	7.0	0.0	0.6	25.0
	I	0.5	1.0	2.8	2.8	0.0	0.3	12.0
Western hemlock, Western redcedar	E	2.2	2.6	15.0	20.0	15.0	1.0	35.0
	I	1.6	1.8	6.0	8.0	6.0	0.5	12.0
Lodgepole pine	E	0.9	0.6	7.0	8.0	0.0	0.6	15.0
	I	0.6	0.4	2.8	3.2	0.0	0.3	7.0
Englemann spruce, Subalpine fir, Mountain hemlock	E	1.1	1.1	10.0	10.0	0.0	0.6	30.0
	I	0.7	0.8	4.0	4.0	0.0	0.3	12.0
Ponderosa pine	E	0.7	0.8	2.5	2.5	0.0	1.4	5.0
	I	0.1	0.1	0.5	0.5	0.0	0.5	0.8

Table 2.8—Decay class and wood density of the tree species found in the northern Idaho FVS variant. The density values are for oven-dry wood. See section 2.4.5 for the decay rates associated with each decay rate class.

Species	Decay rate class	Density lb/ft ³
White pine	4	24.8
Larch	3	34.3
Douglas-fir	1	31.9
Grand fir	3	24.1
Western hemlock	2	29.5
Cedar	2	21.1
Lodgepole pine	4	26.4
Spruce	2	22.6
Subalpine fir	1	21.1
Ponderosa pine	4	26.4
Mountain hemlock & other	4	29.5

2.4.3 Estimation of Tree Material

The boles and crowns of both live trees and snags contribute to the surface fuel pools in the FFE. Therefore, the estimation of the amount of bole and crown material on each live tree has a large impact on fuel amounts and dynamics. The remaining material in this section describes how these amounts are calculated. Section 2.4.4 describes how the material moves from the standing pools to the surface pools.

Estimation of Bole Material: The FFE uses an FVS routine to determine the volume of wood in each bole. In the case of live trees and hard snags, the resulting bole volumes are converted to biomass using wood density values given by Brown and others (1977) and shown in table 2.8. The boles of soft snags are assumed to have only 80 percent of the density of hard snags. All biomass is tracked and reported as dry weight.

When tree boles become surface fuel (as described below), the bole material is partitioned among the size classes shown in table 2.6. The partitioning is done by approximating bole shape as a cone of the specified total height and diameter at breast height. Using this approximation, the length of the bole at each diameter-class breakpoint is determined. These lengths are then used, together with the base FVS model volume routine, to determine bole volume between each breakpoint. No attempt is made to simulate the physical fragmentation or actual piece lengths of boles. The material in each portion of the bole is simply assigned to the appropriate size class at the time the bole falls.

The material from each bole is also assigned a decay rate based on its tree species, as shown in table 2.8. Model users may change the decay rate assignments for each species with the keyword **FUELPOOL**. The model also classifies the down material from each snag bole according to its decay status at the time it falls (hard or soft).

Estimation of Tree Crown Components: The FFE estimates the amount of crown material on each tree using the equations in Brown and Johnston (1976). These equations estimate the total dry weight of live and

dead material in each crown, as well as the proportions of that material in foliage, 0 to 0.25, 0.25 to 1, 1 to 3, and more than 3 inches diameter branchwood.

According to Brown and Johnston's equations, the total amount of crown material and the partitioning of that material among size classes depends on the following variables: tree species, dbh, height, crown ratio, and the tree's dominance position in the stand. The FFE classifies the dominance of trees based on their height. Trees above the 70th percentile (that is, the tallest 30 percent) are considered dominant or codominant, while trees below the 40th percentile are considered intermediate or suppressed. Between these values a linear interpolation is used for estimating crown weight. The crowns of trees classified as species 11 ("other") are estimated from Brown and Johnston's equations for western hemlock.

When crown material becomes surface fuel in the FFE, all foliage is classified as litter and the other crown components enter the appropriate fuel pools based on size and species. As recommended by Jim Brown (USFS, Missoula, MT, pers. comm., 1995), the branch material over 3 inches is all classified as 3 to 6 inch fuel. Fallen crown material is also classified into different pools based on the decay rate of the tree species from which it originates, and whether it originates from a live tree/hard snag or a soft snag.

Except in the case of fire-scorched trees, the amount of crown material associated with each live tree is calculated in every FVS cycle based on the current attributes of the tree record. For one cycle after a tree has been scorched by fire, the amount of crown material associated with that tree is held static at the level remaining immediately after the fire (as described in section 2.5.5).

2.4.4 Sources of Woody Fuel and Litter

Every year, some material is transferred from the crowns and boles of live trees and snags into the appropriate fuel pools. This transfer is based on tree growth and mortality, snag fall and breakage, fires, and management. The the remaining material in this section describes each of these processes in more detail.

Annual Litterfall: The FFE simulates annual foliage litterfall from each live tree using data from Keane and others (1989) on foliage lifespan. The model assumes that 100 percent of the current foliage will fall during the specified leaf lifespan, so that the average proportion of foliage falling each year can be approximated from the inverse of the leaf lifespan. This gives the following equation for annual litterfall from each tree:

$$Litterfall = \frac{Foliage\ Weight}{Leaf\ Lifespan}$$

where:

Litterfall = weight of litter (lbs/year) to fall from this tree in each year of the current FVS cycle;
Foliage Weight = current weight of foliage on this tree (lbs); and
Leaf Lifespan = expected foliage lifespan (years) for this tree species (table 2.9).

In accounting for litterfall, the amount of foliage remaining on the tree is not reduced as we assume that the dropped material is replaced by new growth each year.

Table 2.9—Leaf lifespan data used in calculating annual litterfall. Data shown are from Keane and others (1989). Where this source did not provide data for a species that occurs in the northern Idaho FVS variant, data from another species were substituted as shown in the table.

Species	Leaf lifespan (years)
White pine	data from ponderosa pine
Larch	1
Douglas-fir	5
Grand fir	7
Western hemlock	data from Douglas-fir
Western redcedar	data from Douglas-fir
Lodgepole pine	3
Spruce	6
Subalpine fir	7
Ponderosa pine	4
Mountain hemlock & other	data from ponderosa pine

Crown Lifting: The FFE simulates the die-back of lower branches as a tree grows and the crown lifts. The model assumes that a portion of the woody crown material that was present in the previous cycle has now died and will fall during the current cycle. The amount is estimated from the ratio of the change in height of the base of the crown to the previous total length of the crown. As shown in figure 2.9, this is equivalent to assuming that the crown is cylindrical in shape with crown material evenly distributed throughout this space. In reality, crowns may be broader across the bottom with crown material less dense in this space. Because these factors tend to cancel each other out, the model's simple approximation should not systematically bias the timing of debris inputs.

The woody crown material that has died as a result of crown lifting is assumed to fall at a constant rate during the current FVS cycle. In reality, some material might not fall until later time periods, but there would also be older material from earlier time periods falling in the current year; the two effects would largely cancel each other out. Mathematically, the amount of

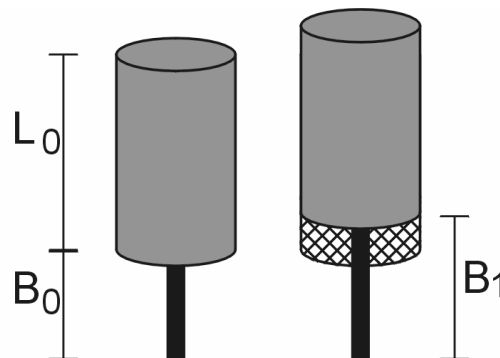

Figure 2.9—Simulation of crown lifting. B_0 is the height of the base of the crown in the previous FVS cycle, B_1 is the height of the base of the crown in the current cycle, and L_0 is the length of the crown in the previous cycle. The FFE assumes that all crown material in the space vacated by the lifting crown – the cross-hatched area in the figure – has died and will fall during the current cycle.

material of each size class (excluding foliage) that will fall due to crown lifting in each year of the cycle is calculated as:

$$Annual\ Fall_i = \frac{B_1 - B_0}{L_0} \left(\frac{W_{oi}}{Cycle\ Length} \right)$$

where:

Annual Fall_i = weight of material (lb/acre/year) in size class *i* to fall from this tree in each year of the current cycle;

B₀ = height of the base of the crown (ft) of this tree in the previous FVS cycle;

B₁ = height of the base of the crown (ft) in the current cycle;

L₀ = length of the crown (ft) in the previous cycle;

W_{oi} = weight of crown material (lb/acre) in size class *i* in the previous cycle; and

Cycle Length = length of the current FVS cycle (years).

The crown material that falls due to crown lifting is assumed to be “hard” when it is added to the surface fuel pools.

The current crown weight is not reduced as a result of these calculations. Current crown weight is a function of the tree characteristics as described above.

Crown lifting calculations also include the material that is removed from the crown during pruning. FVS decreases the length of the crown by the amount that was pruned off. The FFE tracks the change in crown length and simulates the resulting litterfall. In reality, the pruned material would enter the debris pool in 1 year, but in the FFE, since this material is indistinguishable from crown die-back, the material falls throughout the cycle.

Background Crown Breakage: Crown material on live trees may fall as a result of normal background breakage due to snow, wind, disease, or fall-down of adjacent stems. The FFE simulates this breakage by adding a small, constant proportion of each crown component to the debris pools each year. This proportion is set to 1 percent per year and is not under user control. The material is all assumed to be hard when it enters the surface fuel pools. Current crown weight is not reduced as a result of the loss of this material, as it is assumed that new growth replaces it.

Snag Breakage and Crown Loss: The FFE models the breakage and fall-down of snags as described in section 2.3. As each snag breaks or falls naturally, the fallen bole is partitioned into the appropriate size classes and decay rate classes as described in section 2.4.3. The material from each snag is classified as “hard” or “soft” depending on the current decay status of the snag.

Over time, the crowns of snags will also fall and contribute to surface fuel pools. The rate at which this happens is estimated in the model from available data on the amount of foliage, twigs, and limbs remaining 5 years after death (table 2.10). The model uses the estimated time to 100 percent loss to calculate a constant fall-down rate following the death of the snag. For example, 100 percent loss in 10 years means that 10 percent of the material will be scheduled to fall each year for the next 10 years. Two exceptions to this rule occur. First, material will never fall over more than 20 years. Second, the model calculates the time by which a snag will become soft, since soft snags are assumed to have already lost all their branches. The model will cause the

Table 2.10—Rate of crown loss for snags of different species. Data on the amount of each crown component remaining 5 years after death were estimated from a field handbook (Division of Forest Economics 1961). “-” indicates no data were available. The estimated time to 100 percent loss was derived from the available data, with subsequent modifications as requested during model review.

Snag species	Amount remaining 5 years after death (<i>data</i>)				Estimated time to 100% loss (years)			
	Foliage	Twigs	Branches	Large limbs	Foliage	Twigs 0-1”	Branches 1-3”	Large Limbs >3”
White pine	0%	< 75%	—	“numerous” limbs gone	2	5	15	15
Ponderosa pine	0%	< 50%	< 50%	“falling”	2	5	10	10
Spruce	0%	< 30%	< 50%	“falling”	2	5	10	10
Douglas-fir	0%	< 50%	< 75%	“falling”	2	5	15	15
Western hemlock	—	—	—	—	2	5	15	15
True firs	0%	< 50%	< 75%	“falling”	2	5	15	15
Grand fir	—	—	—	—	2	5	15	15
Subalpine fir	—	—	—	—	2	5	15	15
Western larch	—	—	—	—	2	5	15	15
Lodgepole pine	0%	< 75%	< 75%	—	2	5	15	15
Western redcedar	0%	< 60%	—	“some” limbs falling	2	5	20	20
Other	—	—	—	—	2	5	15	15

material to fall over whichever time frame is shorter: the time to 100 percent lost or the time to turn soft.

The fall of snag crown material is scheduled at the time each snag record is created. That is, all of the snag crown material is put into the appropriate pools (based on size and decay-rate class) and scheduled to be added to down fuel pools over succeeding years – pools of “debris-in-waiting”. In this way, the need to store explicit crown data for each snag record is avoided. When snag records are created during model initialization, the FFE schedules only the portion of crown material expected to fall after the start of the simulation. When a salvage operation occurs in the stand, a proportion of the material scheduled to fall in all future years is brought down early and added to fuel pools in the year of the salvage. The proportion brought down is equal to the proportion of total snag volume that was removed by the salvage operation. Similarly, when crown fires occur, a proportion of this material is removed (not added to down fuel) to simulate its consumption in the fire. The proportion removed is set equal to the proportion of the stand in which crown fire occurred, for foliage and one-half the 0 to 0.25 inch branchwood only. Larger branches are not consumed.

All snag crown material is considered hard at the time that it falls because snags are assumed to have lost all their branches by the time they become soft.

Scorched Crowns: As described in section 2.5.5 on fire effects, the FFE simulates the consumption by fire of a portion of small diameter crown material below the scorch height on surviving trees. All crown material below the scorch height that is not consumed in the fire is assumed to have been killed and to fall over the following years in the same manner as is described for snags in the previous section.

Slash: Harvest activity can result in an increase in surface fuel through the creation of slash. Slash is created when crown material from harvested trees is left in the stand, as well as when submerchantable or damaged trees are felled and left in the stand. The **YARDLOSS** keyword allows model users

to specify a proportion of crown material from harvested trees to be left in the stand. The keyword also allows users to specify a proportion of “harvested” live trees to be left in the stand, and whether these stems are left as standing snags or felled. By default, the FFE assumes that all harvested boles are removed from the stand, but that the associated crown material is left in the stand.

2.4.5 Decay Rates

Decay of surface fuel is simulated in annual time steps. By default, 2 percent of the decayed matter from each fuel pool is added to the duff compartment while the remaining biomass is lost as CO₂ and is not tracked by the model. Pools decay according to the equation:

$$Fuel_{t+1} = Fuel_t(1 - r)$$

where:

- Fuel* = weight of fuel in a given pool;
- t* = year (and *t + 1* is the following year); and
- r* = decay rate from table 2.11.

The default decay rates for each size class are based on Abbott and Crossley (1982; table 2.11). Users can change the decay rates using two different keywords: **FUELDCAY** and **FUELMULT**. These change the decay rate for a specific pool, or apply a multiplier to the rates in all pools. The default amount of the lost material that becomes duff is the same for each size class but can be controlled with the **DUFFPROD** keyword.

The FFE can accommodate up to 57 unique decay rates based on size class, decay rate classes, and the hard/soft status of input debris (table 2.6). By default far fewer decay rates are used, decay rate classes are not used, and decay is usually based almost solely on the size class. The one exception is a differential decay rate assigned to debris originating from soft snags. Because this material is less physically cohesive, it is considered more susceptible to decay, and each size class is assigned a rate 10 percent higher than that shown in table 2.11 for the corresponding size class of hard material. The hard/soft attribute applies only to woody fuel; litter and duff are always classified as hard for the purpose of calculating decay.

Table 2.11—Default annual losses due to decay and the proportion of the loss that becomes duff for each of the size class, litter and duff components. These loss rates are for hard material; soft material in all size classes, except litter and duff, decays 10 percent faster.

Size Class Component	Annual Loss Rate	Proportion of Loss Becoming Duff
diam < 0.25"	0.12	0.02
0.25" ≤ diam < 1"		
1" ≤ diam < 3"	0.09	
3" ≤ diam < 6"	0.015	
6" ≤ diam < 12"		
diam ≥ 12"		
Litter	0.5	0
Duff	0.002	

2.4.6 Live Surface Fuel

FFE does not dynamically simulate amounts of live fuel such as herbs and shrubs, but it does represent them with habitat-type specific values. The total fuel load of these materials is felt to be roughly constant in a stand (after canopy closure). Understory herbaceous vegetation is often stimulated by fire. The rapid increase in herb biomass will compensate for the slower recovery of shrub biomass. Fires may change the species composition of the herbs and shrubs, but we assume that the approximate total loading of the live fuel is unchanged.

The values used for the herbs and shrubs are determined from a combination of percent cover and the dominant species in the stand, as determined by basal area. The actual values are based on those used in FOFEM (Reinhardt and others 1997) and modified by Jim Brown (USFS, Missoula, MT, pers. comm., 1995; table 2.12). If there are no trees at the beginning of the simulation, the cover type is determined from the major climax species in the stand's habitat type (Cooper and others 1991; Pfister and others 1977), as is done for the initial fuel levels. Otherwise, the assumed cover type is either the current one calculated from the dominant basal area in the stand, or the last one that was used in the stand if the stand was recently fully cut. The values for herbs and shrubs are calculated annually but will only change if the percent cover or species composition of the overstory changes (from a fire, harvesting, planting, growth, or mortality).

Users cannot change the amount of live fuel or the rules by which the live fuel loads are assigned. Some differences exist in the rules and default values between the different FVS variants.

Table 2.12—Default fuel loadings (tons/acre) for herbs and shrubs based on cover type. If trees are present the values in the two columns labeled “E” (for “Established”) will be used, while if there are no trees (that is, a bare ground simulation), the cover is less than 10 percent, or all trees are smaller than 1" dbh, the values in the two columns labeled “I” (for “Initiating”) will be used.

	Herbs		Shrubs	
	E	I	E	I
Western white pine, Grand fir	0.15	0.3	0.1	2.0
Douglas-fir, Western larch, Western hemlock, Western redcedar	0.2	0.4	0.2	2.0
Lodgepole pine	0.2	0.4	0.1	1.0
Englemann spruce, Subalpine fir, Mountain hemlock	0.15	0.3	0.2	2.0
Ponderosa pine	0.2	0.25	0.25	0.1

2.4.7 Canopy Fuels

Canopy fuel characteristics, including the stand-level canopy base height and canopy bulk density, are calculated as described in Scott and Reinhardt (2001). The model assumes that the amount of crown on each tree is evenly distributed along the crown's length. The model sums the total weight of foliage and fine branchwood (one-half the 0 to 0.25 inch diameter branchwood) from all trees in 1-foot height increments from the ground to the top of the tallest tree. It then calculates the 13-foot running mean weight of crown in each section (fig. 2.10).

Canopy bulk density is the highest average value. Canopy base height is the lowest height at which a 3-foot running mean is greater than 30 lb/acre/foot (.011 kg/m³). Trees less than 6 feet tall are not included in this calculation because they are considered part of the surface fuel complex. Trees over 6 feet tall may contribute canopy fuels between the ground and 6 feet, however, so it is possible to have canopy base heights of less than 6 feet.

2.4.8 Fire Behavior Fuel Models

Predicted fuel loads are important indicators of potential fire behavior and effects. However, most applications of Rothermel's fire behavior model (such as Andrews 1986, Finney 1998) use predefined fire behavior fuel models (Anderson 1982) rather than actual or estimated fuel loads. Thirteen of these

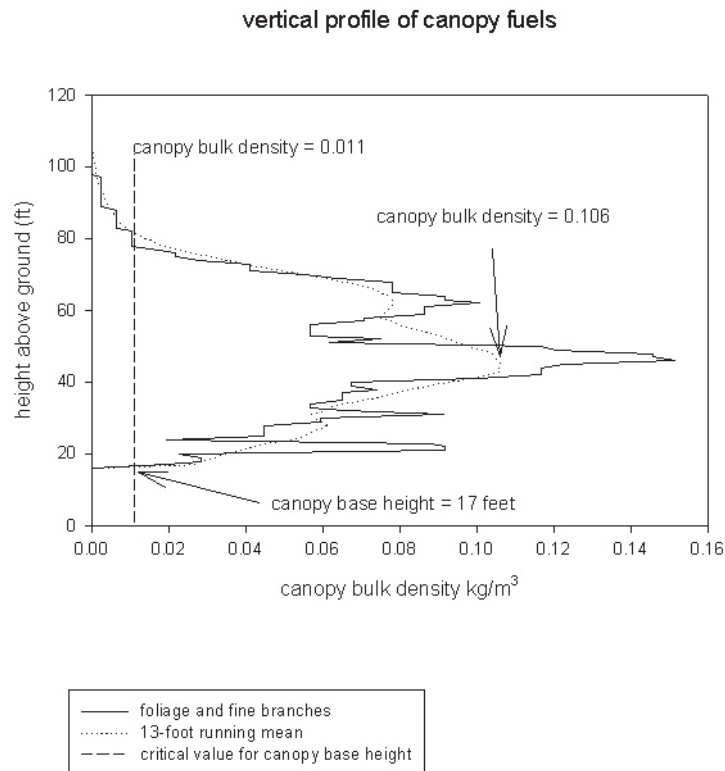

Figure 2.10—Canopy fuel characteristics are determined by examining the vertical distribution of canopy fuels. Canopy bulk density is defined as the maximum of the 13-foot running mean of 1-foot deep layers. Canopy base height is defined as the lowest height at which the canopy bulk density exceeds 0.011 kg/m³.

models are in widespread use (table 2.13), and some regions have customized additional models. Each fuel model is typically used to represent a range of fuel conditions in which fire behavior may be expected to respond similarly to changes in fuel moisture, wind, and slope. The models are named descriptively (for example, timber litter and understory; medium logging slash) and define values for a number of parameters that are difficult to measure in the stand and that are not tracked in the FFE. These parameters include fuel characteristics such as: surface-to-volume ratio, loading, depth, moisture of extinction, heat of combustion, dry density, total mineral content, and silica-free mineral content (table 2.13). Rothermel's fire behavior model uses these parameters to calculate surface fire behavior. Users can change the parameters of existing fuel models, or enter their own customized fire model using the keyword **DEFULMOD**.

FFE simulates fuel loadings by size class over time but does not use these loadings directly as inputs to the fire behavior model. Instead, FFE uses the loadings and other stand characteristics to select one or more of the stylized

Table 2.13—Parameter values for the fire behavior fuel models (Anderson 1982). Fire Behavior Fuel Models 14, 25, and 26 are customized fuel models.

		Name	Surf-vol ratio (1/ft)				Loading (lb/ft ²)				Depth (ft)	Moisture of Extinction
			0-0.25"	0.25-1"	1-3"	Live	0-0.25"	0.25-1"	1-3"	Live		
Fire Behavior Fuel Model	1	Short grass	3500	109	30	1500	0.034	0	0	0	1	0.12
	2	Timber (grass & understory)	3000				0.092	0.046	0.023	0.023	1	0.15
	3	Tall grass	1500				0.138	0	0	0	2.5	0.25
	4	Chaparral	2000				0.23	0.184	0.092	0.23	6	0.20
	5	Brush	2000	109	0	1500	0.046	0.023	0	0.092	2	0.20
	6	Dormant brush, hardwood slash	1750	109	30	1550	0.069	0.115	0.092	0	2.5	0.25
	7	Southern rough	1750	109	30	1550	0.052	0.086	0.069	0.017	2.5	0.40
	8	Closed timber litter	2000	109	30	1500	0.069	0.046	0.115	0	0.2	0.3
	9	Hardwood litter	2500				0.134	0.019	0.007	0	0.2	0.25
	10	Timber (litter & understory)	2000				0.138	0.092	0.23	0.092	1	0.25
	11	Light logging slash	1500				0.069	0.207	0.253	0	1	0.15
	14	Light-medium logging slash	1500				0.126	0.426	0.506	0	1.8	0.2
	12	Medium logging slash	1500				0.184	0.644	0.759	0	2.3	0.2
	13	Heavy logging slash	1500				0.322	1.058	1.288	0	3	0.25
25	Plantation older than 25 years	2000				0.069	0.069	0.092	0.207	3.5	0.25	
26	Modified FM 4	2000				0.1242	0.1242	0.0828	0.1656	3.6	0.35	

fuel models that best represent the fuel. The rules used to select the fire behavior fuel models vary among the geographic variants of FFE-FVS.

FFE can use the fire behavior fuel models in two ways: static or dynamic. The static option selects the single model that best represents current conditions. Figure 2.11 shows an example of four possible fuel models for natural fuel in closed stands with predominantly dead surface fuel as regions on the graph of small versus large fuel. Within each of these regions, Fuel Model 8, 10, 12 or 13 is used. For example, if the fuel loading is as shown by the point in the figure, Fuel Model 12 is selected.

Once the fuel model is selected, its parameters are used to calculate fire behavior. This approach, while useful in many applications, has a disadvantage when simulating changes in fuel and potential fire behavior over time. Since there are a small number of fire behavior fuel models, as fuel changes over time the same model may be selected and predicted fire behavior remain constant. At the time step when another fuel model is selected there may be dramatic changes in fire behavior with only a tiny change in simulated fuel conditions. A more reasonable result is a gradual change in predicted fire behavior corresponding to the gradual changes in fuel.

Because of this drawback, we developed the dynamic option for selecting fuel models. The dynamic method selects two or more fuel models based on fuel loads and other stand characteristics, calculates the resulting fire behavior for each fuel model, and takes a weighted average of the results.

The selection of the fuel models and their weights depends on stand conditions, including fuel loads. For example, fuel loads might place the stand somewhere in the diagram in figure 2.12. The model computes the

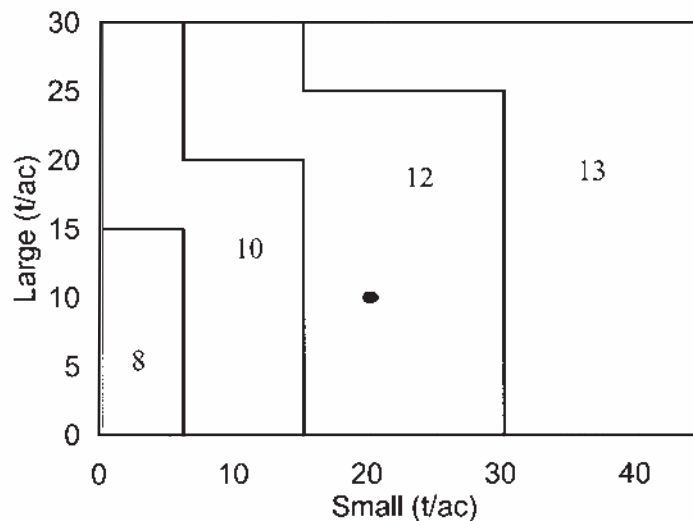

Figure 2.11—Regions defined for each static fuel model (numbers 8, 10, 12, 13), based on large (> 3" diameter) and small (< 3" diameter) woody fuel (ton/acre). The regions here correspond to fuel models for natural fuel in closed stands for many habitat types, with the model number shown in the region. Similar regions exist for activity fuel and fuel from dry grassy or dry shrubby habitat types. The combination of small and large fuel quantity indicated by the point will result in the selection of Fuel Model 12.

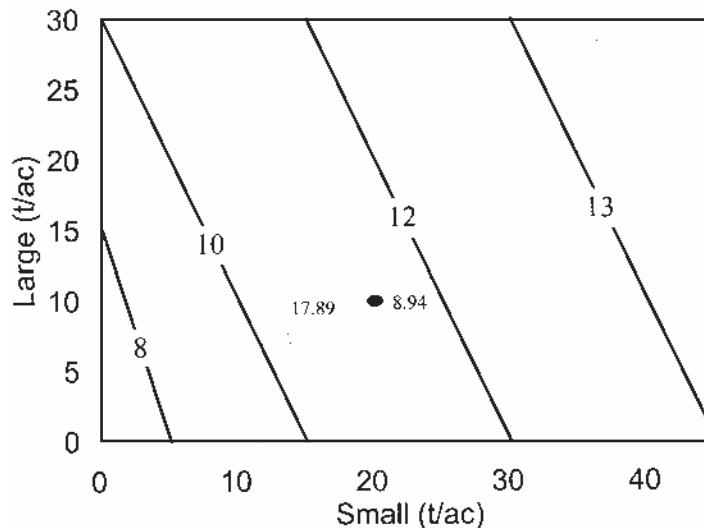

Figure 2.12—An example of dynamic fuel modeling, based on large and small woody surface fuel. The lines here correspond to fuel models for natural fuel in closed stands for many habitat types, with the fuel model number shown on the line. Similar lines exist for activity fuel and fuel from dry grassy or dry shrubby habitat types. The point shown here will result in an interpolation using Fuel Models 10 and 12, as described in the text.

shortest distance to each of the nearest neighboring fuel model lines. For combinations of fuel found in the lower left corner or upper right corner in the example, there will be only one nearest neighbor (Fuel Model 8 or 13 respectively, in figure 2.12). Typically though, there will be two neighbors. Once the distance to each neighboring fuel model is known, the influence of each fuel model is calculated by using the inverse of the distance from the fuel model line to the current condition as a weight. In figure 2.12, the distance from the sample point (small = 20; large = 10) to neighboring Fuel Model 12 is 8.94 units; the distance to Fuel Model 10 is 17.89 units. The resulting fire behavior will be more like Fuel Model 12, which is nearer than Fuel Model 10, but the contributions of both models will be present. The weights of the two models, W_{10} and W_{12} can be calculated in this example as:

$$W_{10} = \frac{1/17.89}{(1/17.89) + (1/8.84)} = 0.33$$

$$W_{12} = \frac{1/8.94}{(1/17.89) + (1/8.84)} = 0.67$$

where

W_{10} = weight for Fuel Model 10; and

W_{12} = weight for Fuel Model 12.

In this example, fire intensity will be computed as a weighted average of the intensity predicted using Fuel Model 10 (33.3 percent) and Fuel Model 12 (66.7 percent).

In more complex examples, it is possible to define fuel model lines that are not parallel (as in the example) or that are horizontal or vertical. In these

cases, the interpolation searches to the left and right of the sample point, and then searches above and below the sample point. Based on these searches, between one and four unique neighboring models may be found, and the same weighting system will be used to compute the influence of the neighboring models. In all current variants, however, the fuel model lines are oriented similarly to the ones shown in this example.

Fuel loads provide the system for weighting when woody surface fuels dominate the fuel complex. In situations where woody fuels are sparse and litter, shrubs or herbaceous fuels dominate, a similar distance-based weighting system is used based most often on the amount of canopy coverage.

The benefit of the dynamic approach is that the calculated potential fire intensity varies continuously as fuel conditions change in the stand. Figure 2.13 shows the flame length predicted by different small (0 to 3 inches) and large (3 inches+) woody fuel loads using the static and dynamic approaches.

Users can choose whether to use the static or the dynamic standard fuel models using the keyword **STATFUEL**. They cannot, however, change the definition of the fuel regions or lines (that is, the fuel levels at which different fuel models apply). These definitions are customized in the development of regional variants of FFE.

The logic used by FFE to select fire behavior fuel model(s) varies between FFE variants and is one of the main differences between FFE variants. Complete selection logic for each variant is contained in chapter 4. Users can also set fuel models in any year using the keyword **FUELMODL**.

Certain common features are present in all variants, however. In all cases, different selection logic is used for natural and activity fuels (fuels resulting from harvesting within the last 5 years), and for high and low woody fuel loads. All variants use the same logic for activity fuels and when woody debris is abundant. In these cases, the fuel model depends only on the amount of

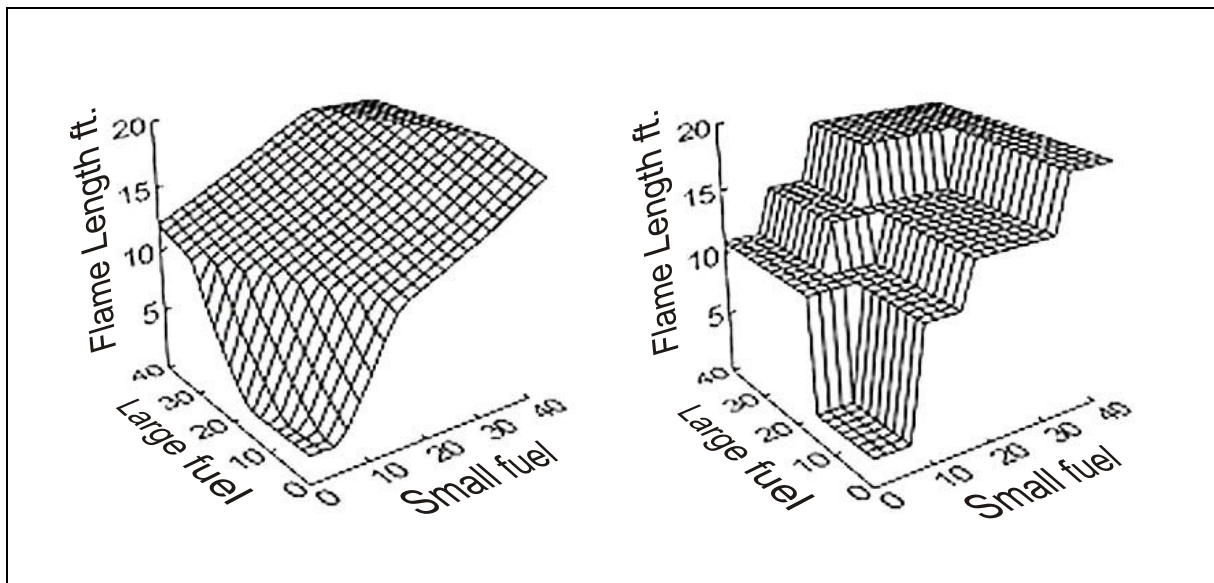

Figure 2.13—Example of predicted flame length over a range of small and large woody fuel loads (tons/acre). Predictions using the dynamic option are on the left, and predictions using the static option are on the right.

small (less than 3 inches) and large (greater than 3 inches) fuel in the stand, and whether the fuel is “natural” or “activity” (table 2.14).

At low natural fuel loads in the northern Idaho variant, the fuel model depends on habitat type and crown closure. The habitat types are divided into dry grassy types, dry shrubby types, and all other habitat types. For the dry grassy and shrubby types, the fuel model choice is further defined by the canopy closure of the stand (table 2.15). The rules for choosing a fire behavior fuel model at low fuel loads vary widely between FFE variants.

2.4.9 Management

Management can affect surface and canopy fuel in different ways, either directly or indirectly. FFE-FVS allows simulation of a full range of thinning treatments, prescribed fire, and mechanical fuel treatments. When thinning is simulated using base model keywords, FFE can simulate creation of activity fuel (see section 2.4.4). Thinning also changes canopy fuel characteristics – amount of canopy fuel, canopy base height, and canopy bulk density. Other surface fuel treatments are specific to the FFE and do not interact with base model thinning keywords. These management options include treatments that affect fuel depth, reduce fuel loading, or reduce fuel size.

Table 2.14—Rules for determining the Fuel Model based on fuel loadings. These rules are used if woody fuels are abundant and for activity fuel. Table 2.15 shows the rules used if woody fuels are sparse.

Fuel loading (t/acre)		Fuel model	
Small (<3")	Large (3+")	Natural	Activity
<6	≤15	use other rules	11
	>15	10	14
6-15	≤20	10	14
	>20	12	12
15-30	≤25	12	12
	>25	13	13
>30	≥0	13	13

Table 2.15—Rules for determining the Fuel Model at low woody fuel loads. For stands that are between the percent cover values listed below, the fire behavior will be based on a combination of the two fuel models (unless the static option is being used).

Habitat type	Percent cover	Fuel model
Ponderosa pine / bluebunch wheatgrass (130)	<20	1
	>60	9
Ponderosa pine / common snowberry (170) Douglas-fir / common snowberry (310)	<20	2
	>60	9
Other	any	8

Methods Affecting Fuel Depth: Several harvest methods can be simulated as well as different types of mechanical slash treatments. Harvesting and mechanical fuel treatment methods have no effect on the volume harvested by FVS or on the quantity of logging residue left on site. The methods do affect the depth of the logging residue, and thus overall fuel depth. In the FFE, fuel depth affects fire intensity but not fuel consumption.

Three harvesting options are available in the FFE: (1) ground based (including cat skidding and line skidding); (2) high lead (including skyline); and (3) precommercial or helicopter. Any other type of harvesting is assumed to have no impact on fuel depth.

Two general types of slash treatments are also available: (1) trampling / crushing / chopping / chipping; and (2) flailing / lopping. No other type of slash treatment (excluding burns, which are discussed in section 2.5) impacts fuel depth. The slash treatments specified here have no impact on the actual size distribution of fuels. Treatments affecting size must be simulated differently (see below).

The harvest method and slash treatment are used to determine a multiplier for fuel depth (table 2.16). If no activity is specified at the time of a harvest, no multiplier will be applied (that is, fuel depth will not be changed). The multiplier can be changed with the keyword **FUELTRET**.

Multipliers are applied for 5 years following a stand entry. After that time, fuel from activities is assumed to have the same depth as natural fuel.

Methods Affecting Fuel Loads: Burning fuel to reduce fuel loadings is a common practice. Broadcast burning, piling and burning fuel, and jackpot burning are discussed in section 2.5.3.

Fuel loads can also be manually increased or decreased with the **FUELMOVE** keyword to simulate treatments involving fuel removals or to ensure that fuel levels are at some predetermined level.

Methods Affecting Fuel Size: Chipping or other treatments that reduce fuel size can be simulated independently of any harvesting action in the model. They move material from the larger fuel classes to the smaller fuel classes, without reducing fuel loads or affecting fuel depth. These treatments are scheduled using the **FUELMOVE** keyword.

2.4.10 Output

Using the keyword **FUELOUT**, the user can request the detailed fuel report, a table describing fuel in specific years or at specific intervals. The report contains information about surface fuel and standing dead and live fuel, consumed fuel, and removed fuel (table 2.17). All values, including the live components, are given in dry weight, tons per acre. All fuel is included

Table 2.16—Default fuel depth multipliers based on harvest type and slash treatment method.

Harvest method	Slash treatment type		
	None	Trampling etc.	Flailing etc.
Ground based	1.0	0.83	0.75
High lead	1.3	0.83	0.75
Precommercial	1.6	0.83	0.75

Table 2.17—Example detailed fuel report. This example reports every 5 years, but users can request any desired time interval. Notice that a fire in 2065 consumed surface fuel and killed trees (moved standing live biomass to standing dead). Notice also the sharp increase in surface woody fuels in 2070. This is a result of fire-killed trees breaking up and falling down. For the 0-3" fuels this peak is short-lived because smaller materials fall quickly and begin to decompose. The >3" material continues to accumulate over the remainder of the simulation period, as standing dead tree boles slowly fall over. By comparing the columns showing surface fuel and standing dead, one can track the process of dead wood falling to the forest floor.

***** FIRE MODEL VERSION 1.0 *****																			
ALL FUELS REPORT																			
ESTIMATED FUEL LOADINGS																			
SURFACE FUEL (TONS/ACRE)										STANDING WOOD (TONS/ACRE)									
DEAD FUEL							LIVE			DEAD		LIVE			TOTAL BIOMASS		TOTAL BIOMASS		
YEAR	LITT.	DUFF	0-3"	>3"	3-6"	6-12"	>12"	HERB	SHRUB	SURF TOTAL	0-3"	>3"	FOL	0-3"	>3"	TOTAL	BIOMASS	CONS	REMOVED
1993	1.24	9.8	3.3	7.9	4.2	3.8	.0	.21	.28	22.8	.00	25.6	4.6	9.6	44	84	107	0	0
1995	1.73	9.8	3.3	10.2	5.6	4.5	.0	.21	.28	25.5	.00	22.4	4.6	9.6	44	81	106	0	0
2000	2.02	9.8	4.4	15.5	9.2	6.3	.0	.21	.30	32.3	.83	16.4	4.7	10.5	49	81	113	0	0
2005	2.04	9.9	7.3	20.8	12.8	8.0	.0	.21	.31	40.6	.65	9.4	4.8	10.8	52	78	118	0	0
2010	2.06	10.0	7.6	25.1	15.5	9.5	.1	.21	.32	45.3	.80	3.8	4.9	11.1	55	76	121	0	0
2015	2.28	10.2	7.4	24.4	15.0	9.3	.1	.21	.32	44.8	.80	4.0	5.8	11.8	58	80	125	0	0
2020	2.47	10.3	7.2	23.8	14.5	9.1	.2	.21	.32	44.4	.69	3.9	5.9	11.9	62	84	128	0	0
2025	2.49	10.4	7.2	23.2	14.0	9.0	.2	.21	.32	43.9	.68	4.0	5.9	12.1	65	88	132	0	0
2030	2.49	10.6	7.1	22.8	13.6	8.9	.3	.21	.32	43.4	.72	4.2	5.9	12.4	68	92	135	0	0
2035	2.56	10.7	6.9	22.4	13.1	8.8	.4	.21	.32	43.1	.74	4.6	6.2	12.8	72	96	139	0	0
2040	2.63	10.8	6.9	22.1	12.7	8.8	.6	.21	.31	42.9	.70	4.7	6.3	13.1	75	100	142	0	0
2045	2.63	11.0	6.8	21.9	12.3	8.9	.7	.21	.31	42.7	.73	4.9	6.3	13.3	78	103	146	0	0
2050	2.63	11.1	6.7	21.7	11.9	9.0	.8	.21	.30	42.7	.76	5.2	6.2	13.5	81	107	149	0	0
2055	2.66	11.2	6.6	21.7	11.6	9.2	.9	.21	.30	42.7	.79	5.6	6.4	13.9	84	111	153	0	0
2060	2.70	11.3	6.5	21.7	11.3	9.4	1.1	.21	.29	42.8	.74	5.6	6.5	14.2	87	114	157	0	0
2065	.00	2.6	1.0	4.9	.5	3.6	.8	.21	.29	9.1	16.92	95.8	.0	.0	0	113	122	52	0
2070	.28	2.7	11.2	39.1	9.5	24.9	4.7	.40	1.00	54.7	3.06	55.8	.0	.0	0	59	114	0	0
2075	.03	2.9	8.3	50.9	11.6	31.1	8.2	.40	2.00	64.5	1.53	39.0	.0	.1	0	41	105	0	0
2080	.07	3.0	6.1	56.1	12.1	32.6	11.5	.38	.92	66.6	.00	29.4	.2	.3	0	30	96	0	0
2085	.13	3.1	3.6	60.7	12.1	34.1	14.5	.34	.72	68.6	.00	20.1	.3	.7	0	21	90	0	0
2090	.25	3.2	2.2	64.3	11.6	35.4	17.3	.30	.54	70.8	.02	11.5	.6	1.7	0	14	85	0	0
2095	.49	3.3	1.4	64.6	10.8	34.7	19.0	.25	.34	70.4	.04	6.2	1.2	2.5	3	13	83	0	0

in this table, as are all removals except decay. The following is a short description of the columns in the output table.

- Year
- Surface fuel
- Dead
 - Litter
 - Duff
 - 0 to 3 inches woody
 - Greater than 3 inches woody (This column is the sum of the three columns following)
 - 3 to 6 inches woody
 - 6 to 12 inches woody
 - Greater than 12 inches woody
- Live
 - Herbs
 - Shrubs
 - Total
- Standing wood
 - Sum of all surface fuels (both Dead and Live)
 - Reported in tons per acre
 - Dead
 - 0 to 3 inches
 - Greater than 3 inches
 - Small diameter snags and branches
 - Larger diameter snags and branches

	Live
	Foliage
	0 to 3 inches branch and stem wood
	Greater than 3 inches branch and stem wood
	Total Total standing wood (Dead and Live)
Total Biomass	Total (tons per acre) of all standing wood and surface fuels
Total Consumption	Total amount of fuel (not including live trees) that was consumed in a fire. In most years this column will be zero, but if a fire was simulated this value is the same as that reported in the fuel consumption report (section 2.5.7). Consumption will not be shown if it occurs in a year when no output is requested.
Biomass Removed	Amount of wood that was harvested (live or dead) in tons per acre. This includes removals from standard base model thinning as well as salvage. Removals from pruning may not be present. Removals will not be shown if they occur in years when no output is requested.

This report provides a look at the dynamics of live and dead, standing and surface biomass. Before simulating management, a user might run a no-management simulation to assess model performance (see if predicted fuel loads are reasonable) and possibly calibrate the model by adjusting snag or fuel keywords. Then, a number of management alternatives can be simulated and results compared in terms of predicted fuel loads over time. If management objectives are expressed in terms of an acceptable range of surface fuel loadings, prescriptions can be developed by repeatedly changing treatment prescriptions and examining this report to see whether objectives are met.

This report is printed at the end of the simulation year, after all other FFE activities have occurred, but before the base model has applied the growth and mortality estimates. This means that the change in any fuel pool could be the result of many factors. For example, in the first year of the simulation, the output report combines the results of the initial conditions with input from any trees and snags, and removals due to decay. Thus, the fuel levels reported in the table for the first year can be quite different from those that were set by the user or by the default values.

Harvesting, fuel treatments, and fires can further confuse the interpretation or the output or the predictions of changes in fuel levels. The last two columns showing the removals can give some indication of the level of impact expected from harvest or fire. The fuel consumption report can also aid in interpretation of the table because it shows, for each surface fuel class, how those pools are affected by fire.

Note that the snag output reports are printed at the beginning of the simulation year. Thus, the reported snag values in the snag reports and the fuel reports could be different, especially if a fire or salvage occurred in that time step. Also note that the snag and fuel reports use different units for reporting purposes, further confounding any attempt at comparison between the reports.

The change in stand biomass from one year to another can be calculated as:

$$TotBio_t = TotBio_{t-1} - TotalConsumption - Removals - Decay + Growth$$

The growth and decay terms are not explicitly included in the table, so their net contribution must be inferred. Decay is applied every year to all surface fuel and dead standing fuel, while growth is added only at cycle boundaries and only to standing live fuel. The equations for individual pools are similar but include terms representing transfer to and from other pools.

Some changes in pool size can be tracked between different parts of the table. Large standing live may become large standing dead. Standing dead will become surface fuel, and some portion of the surface fuels will become duff.

When no fires or other actions are simulated, the biggest changes in fuel levels will occur on cycle boundaries. Within a cycle, only decay is simulated, resulting in a slow decline in surface fuel levels and standing dead levels (through height loss and fall-down). On cycle boundaries, growth and mortality estimates are applied to the standing live component, resulting in a relatively large change in standing live and an increase in standing dead pools

2.5 Fire Submodel

2.5.1 Overview

The FFE-FVS uses the fire submodel two ways. First, model users can simulate the effect of a prescribed fire or wildfire at any point in time. Repeated fires can be simulated, and fires can be set at random times or when certain conditions are met. If a fire is simulated in this way, it modifies stand and fuel conditions by killing trees and consuming fuel, and alters future stand and fuel dynamics. The second method uses exactly the same calculations to examine *potential* fire behavior and effects without actually changing any of the stand conditions. In this case, managers can assess the changing fuel conditions by examining predicted changes in fire characteristics and impacts. Typically one might look at potential fire behavior and effects over the course of the simulation period, possibly also scheduling one or more fires along the way.

The fire model receives input from other model components. Users provide simulation instructions such as the year to simulate fire or calculate potential fire effects, and the conditions at the time of the burn. FVS provides detailed information about all the trees in the stand. The fuel component of the FFE provides information on surface fuel loadings and canopy fuel characteristics. The fire model can then calculate the predicted effects of the fire on fuel, live trees, and snags, as well as fire characteristics such as flame length and whether the fire is a crown fire. This section describes the fire model in more detail. First, fire conditions are discussed. Methods for calculating fire behavior are then presented. We then discuss fire effects including tree mortality, fuel consumption, and smoke production. Use of potential fire calculations follows, and finally, fire related output tables are summarized.

2.5.2 Burn Conditions

In nature, the conditions under which a fire burns have a large impact on its behavior and effects. Users can specify fuel moisture content, wind speed, and ambient air temperature using various keywords, or they can choose from a set of predefined conditions using the **SIMFIRE** keyword. The model does not simulate changes in any of these environmental variables over time, so the values must be entered for each simulated fire. Other conditions, such as slope and fuel loading, cannot be altered by the user at the time of a fire. Slope is a constant that is established at the beginning of the simulation, and fuel loading is simulated by the FFE (see section 2.4).

If a fire is scheduled with the **SIMFIRE** keyword, it will be simulated and result in tree mortality and fuel consumption even if burn conditions are marginal.

Fuel Moisture: The fuel moisture content (weight of water/dry weight of fuel expressed as a percentage) is used to calculate fire intensity and fuel consumption. Each fuel size class, except litter, must have an assigned moisture value. Users can choose one of four predefined fuel moisture combinations in the model (table 2.18), or specify the moisture conditions for each of the classes using the **MOISTURE** keyword.

While all moisture levels affect fuel consumption, only the values for the live and the small (less than 3 inches) fuel are used to calculate fire intensity. In general, wetter fuel produces shorter flames (fig. 2.14) and results in less fuel consumption, as is described further in section 2.5.5.

Wind Speed: Fire intensity increases with increasing wind speed. The default wind speed is 20 miles/hour. Users can set the wind speed using the **SIMFIRE** keyword.

Both the default wind speed and the value entered by the user describe the wind speed at 20 feet above the ground level or the top of the vegetation if any. This value is then converted to an expected mid-flame wind speed by multiplying it by a correction factor based on the canopy closure in the stand (fig. 2.15) (Albini and Baughman 1979).

Canopy closure is calculated from the total area occupied by crowns in the stand using the assumption that crowns are randomly distributed within the stand. It is determined by finding the width of the crown of each tree (Moer 1981), calculating the associated area, and summing this area for all the trees

Table 2.18—Default percent fuel moisture for the four predefined moisture conditions for each fuel size class.

	Moisture level			
	Very dry	Dry	Moist	Wet
0-0.25" (1 hour)	4	8	12	16
0.25-1" (10 hour)	4	8	12	16
1-3" (100 hour)	5	10	14	18
>3"	10	15	25	50
Duff	15	50	125	200
Live	70	110	150	150

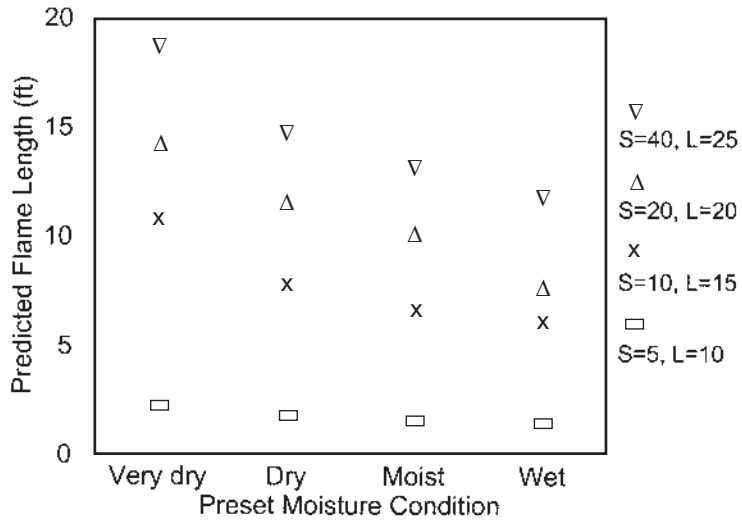

Figure 2.14—Example flame lengths for each of the predefined moisture conditions for four different combinations of small ($S < 3$ in) and large ($L > 3$ in) fuel amounts (in tons/acre). Other factors being equal, the flame lengths decrease as moisture levels increase.

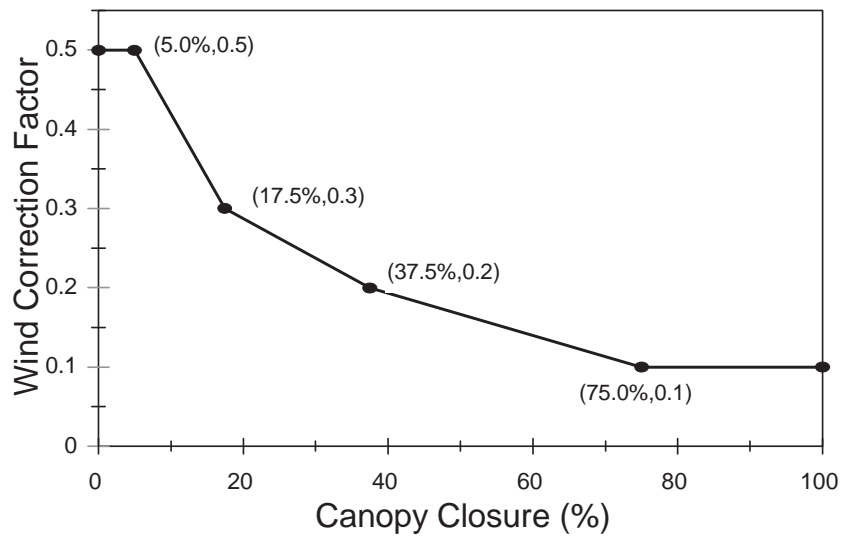

Figure 2.15—The correction factors used to calculate mid-flame wind speed from wind speed at 20 feet above the ground or the top of the vegetation.

in the stand. Because all calculations in the stand are on a per acre basis, the total area is also based on an acre. This total area is then used to calculate percent cover (Crookston and Stage 1999):

$$PercentCover = 100(1 - e^{-TotalCrownArea/43560})$$

where:

- PercentCover* = percent cover in the stand;
- TotalCrownArea* = total area (per acre) covered by crowns (measured in square feet); and
- 43560 = number of square feet in an acre.

Air Temperature: The ambient air temperature (∞ F) at the time of a fire affects scorch height, and thus tree mortality. Scorch height increases exponentially with temperature (fig. 2.16) (Van Wagner 1973). This is the only use of temperature in this model. The indirect effects of air temperature on fire behavior as fine fuel dries in response to heating are not simulated; fuel moisture content is a required user input.

2.5.3 Controlling Fire Extent

Continuous Burns: In FFE, by default, fires impact the entire area of the stand (that is, no unburned patches remain). Continuous fires (either prescribed fires or wildfires) are scheduled using the **SIMFIRE** keyword.

Pile burns: *Pile burns* do not impact the entire area within the stand, but burn concentrations of fuel. This kind of fuel treatment is requested with the **PILEBURN** keyword. By default, in pile burning, 80 percent of the fuel from 70 percent of the stand is concentrated into piles that cover 10 percent of the stand area (fig. 2.17, left). These piles are assumed to be far enough from trees not to cause any mortality.

Jackpot burns are a special kind of pile burn. They are more widespread, burning by default 30 percent of the stand (fig. 2.17, right). The model assumes that the majority of the fuel is in the burned part of the stand (by default, 65 percent of the stand's fuel). Because there is less effort to avoid

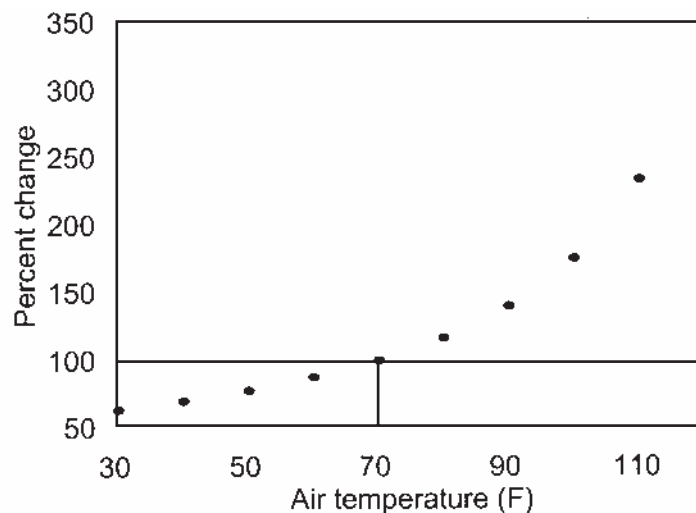

Figure 2.16—The change in scorch height as temperature changes. In this figure, the scorch heights are relative to the scorch height at an air temperature of 70° (the default value). Thus, at 105° the scorch height would be about two times (200 percent) higher than at 70°.

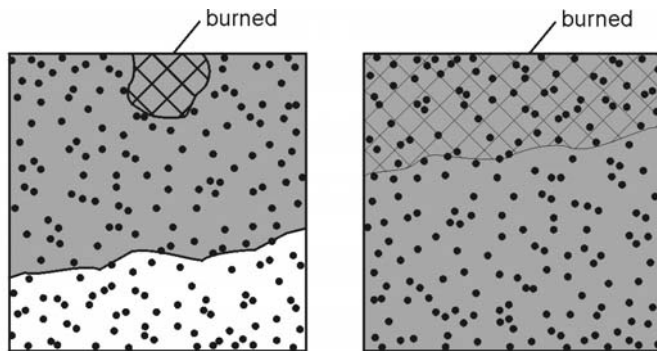

Figure 2.17—Schematic diagram of the difference between pile burning (left) and jackpot burning (right). Each diagram represents a stand. The shaded areas are the areas from which fuel is concentrated. The hatched area represents the area that is then burned.

burning near trees, 50 percent of the trees in the burned area are assumed to die as a result of the burning.

In both cases, 100 percent of the litter and duff in the burned area are consumed, and all of the burned area will have the mineral soil exposed. In addition, 100 percent of piled fuel less than 1 inch and 90 percent of the piled fuel greater than that are burned. Smoke production is calculated assuming that the burned fuel contains the preset “moist” moisture values.

Afterwards, any unburned, piled fuel is assumed to again have the characteristics of unpiled fuels. Decay rates are unchanged by piling, and the burned and unburned areas are not tracked separately in the remainder of the simulation.

All parameters defining the area of the stand, the amount of fuels that are treated, and the associated tree mortality can be changed using the **PILEBURN** keyword.

2.5.4 Fire Behavior

Overview: FFE computes two indicators of fire behavior: flame length and fire type: surface, passive crown fire, or active crown fire. In addition, two indices of crown fire hazard are reported: the torching and crowning index.

Fire behavior in FFE-FVS is computed using methods developed by Rothermel (1972), Albini (1976a), Scott and Reinhardt (2001) and Scott (2001). Surface fuels are assessed to determine which fire behavior fuel models best represent current conditions (section 5.4.2). The selected fuel models, along with slope, user specified fuel moistures and 20-foot wind speed, and canopy closure, are used to compute the intensity of a surface fire (section 5.4.4). This computed intensity and the canopy base height determine the occurrence of torching. Active crowning is modeled if: (1) conditions support torching, and (2) canopy bulk density is great enough to support active crowning at the specified wind speed and fuel moisture conditions (section 2.5.4). If torching or crowning occurs, intensity is recalculated to take into account the contribution of canopy fuels and accelerated fire behavior. Flame length is then computed from intensity.

Fire behavior is an important output of FFE. It also impacts subsequent model behavior by causing tree mortality and thus impacting future stand and fuel dynamics, and influencing fuel consumption, further impacting future fuel dynamics.

Surface Fire Behavior: Surface fire intensity is calculated using Rothermel’s 1972 fire behavior prediction model, as implemented in FIREMOD

(Albini 1976a). Fire intensity depends on static variables such as slope, variables that depend on stand conditions such as fuel quantities (represented by fire behavior fuel models) and mid-flame wind speed, and environmental variables specified by the user, such as fuel moisture levels. Surface fire intensity is used to calculate flame length and scorch height, which affect tree mortality and growth. It is also used to determine the amount of crowning in the stand.

Intensity of continuous fires is computed by the FFE. If users wish to control predictions of fire intensity more closely, they can use the **FLAMEADJ** keyword to specify either the flame length or a flame scaling factor. These adjustments apply only to surface fires.

Crown Fire: Crown fires are typically faster moving than surface fires, more difficult to suppress, and result in more tree mortality and smoke production. FFE-FVS uses information about surface fuel and stand structure to predict whether a fire is likely to crown.

Two crown fire hazard indices are calculated in the model: torching index and crowning index. Torching index is the 20-foot wind speed (in miles per hour) at which a surface fire is expected to ignite the crown layer, while crowning index is the 20-foot wind speed (in miles per hour) needed to support an active or running crown fire. Torching index depends on surface fuels, surface fuel moisture, canopy base height, slope steepness, and wind reduction by the canopy. As surface fire intensity increases (with increasing fuel loads, drier fuels, or steeper slopes), or canopy base height decreases, it takes less wind to cause a surface fire to become a crown fire. Crowning index depends on canopy bulk density, slope steepness, and surface fuel moisture content. As a stand becomes denser, active crowning occurs at lower wind speeds, and the stand is more vulnerable to crown fire. For both indices, lower index numbers indicate that crown fire can be expected to occur at lower wind speeds, so crown fire hazard is greater at lower index values. The complete algorithms for determining torching and crowning index are described in Scott and Reinhardt (2001).

Both torching and crowning index depend in part on surface fuel moisture, therefore these conditions must be specified. Drier conditions produce lower indices, indicating a more severe risk of crown fire. Temperature and wind speed do not affect the indices.

Torching and crowning indices, together with the specified wind speed (set using keywords **SIMFIRE** or **POTFWIND**), determine the amount of crowning. Three outcomes are possible (table 2.19):

1. Surface fires – crowns do not burn (if the specified wind speed is less than the torching index)
2. Active crown fires – the fire moves through the tree crowns, burning all crowns in the stand (thus killing all trees); (specified wind speed is greater than the torching and crowning index)

Table 2.19—Rules for determining the occurrence of crowning. Wind speed is the mid-flame wind speed (in miles per hour) at the time of the fire.

	Torching Index < Wind Speed	Torching Index > Wind Speed
Crowning Index > Wind Speed	PASSIVE	SURFACE
Crowning Index < Wind Speed	ACTIVE	SURFACE

3. Passive crown fires – some crowns will burn as individual trees or groups of trees torch (specified wind speed is greater than the torching index but less than the crowning index)

Users can override this prediction by entering their own value for the percent of the canopy that experiences crowning in a particular fire (using the **FLAMEADJ** keyword).

If torching or crowning occurs, intensity and flame length are recalculated using methods in Scott and Reinhardt (2001) and Scott (2001).

2.5.5 Fire Effects

When a fire is simulated, the FFE calculates several effects from the fire: tree mortality, crown scorch, fuel reduction, mineral soil exposure, and smoke production.

Effects on Trees: Fires can kill trees and can have a short-term effect on tree growth for some of the surviving stems. Probability of tree mortality, P_{mort} , is calculated based on scorch height, crown length, diameter, and species (Ryan and Reinhardt 1988):

$$P_{mort} = \frac{1}{1 + e^{(-1.941 + 6.313(1 - e^{-b}) - 0.000535c^2)}}$$

$$b = v_{sp}d$$

$$c = 100s \left(\frac{2l - s}{l^2} \right)$$

where:

b = bark thickness (inches). This is not necessarily the same bark thickness equation as the one used by the base FVS model.

v_{sp} = species bark thickness parameters (table 2.20);

d = diameter (in inches) of the tree;

c = percent of the crown volume that is scorched;

s = length of the crown (feet) that is scorched; and

l = total length of the crown (feet).

The resulting mortality is shown in figure 2.18. This equation predicts some mortality of thin-barked trees even if none of the crown is scorched ($c=0$). The amount of mortality in this case is dependent just on species and diameter. In all fires, at least 80 percent of the spruce of any size is killed.

When the scorch height is greater than the base of a tree's crown, but the tree is not killed, the crown is assumed partially killed. In these cases, the crown ratio of the tree is reduced and the growth of that tree may be slowed for the subsequent cycle. In the following cycle, FVS will recalculate the crown ratio assuming the tree is healthy but taking into account that the fire reduced the crown length.

Table 2.20—Parameter values v_{sp} used in the calculation of bark thickness.

	WP	L	DF	GF	WH	C	LP	S	AF	PP	Oth
v	0.035	0.063	0.063	0.046	0.040	0.035	0.028	0.036	0.041	0.063	0.040

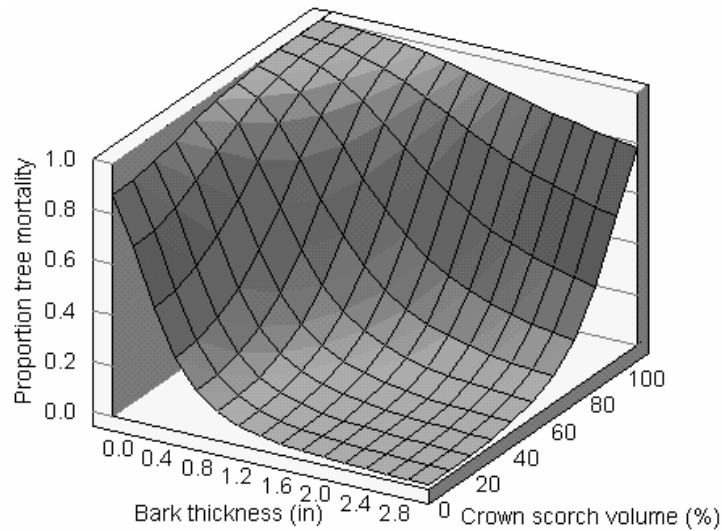

Figure 2.18—Predicted tree mortality is based on bark thickness and the percent of the volume of the crown scorched.

Scorched foliage and branches are assumed to be killed and will fall to the ground at the rates specified for the crowns of snags (section 2.4.4).

The portion of a crown that is within the flames of either a surface or crown fire is killed. FFE assumes that 100 percent of the foliage and 50 percent of the small branch wood (smaller than 0.25 inches) in the flames are consumed. The remainder of the burned portion of a crown is assumed to be dead and falls at the same rate as scorched canopy material.

More complicated effects of fire on trees may include increased susceptibility to insects and disease, decreased growth due to fine root mortality, or increased growth due to enhanced nutrient availability. These effects are not represented by the FFE-FVS. Fire may also indirectly result in increased tree growth of residual trees due to decreased stand density, and this effect is simulated by FVS.

Fuel Consumption: Fuel consumption algorithms in FFE are simplified from those in FOFEM (Reinhardt and others 1997). The three main factors affecting fuel consumption are: size, moisture content, and type (natural, activity, or piled) (Brown and others 1985; Ottmar and others 1993). The intensity of the fire does not directly affect surface fuel consumption in the FFE.

The consumption of both activity and natural fuels greater than 3 inches depends on moisture and the size class of the fuels. Dry large woody fuel is more fully consumed than wet (fig. 2.19). The model assumes that at high moistures, natural fuel is more fully consumed than activity fuel because, in general, it is on the ground and partially rotted, while the activity fuel tends to be sound, green, and not as close to the ground.

The consumption of small fuel less than 1 inch diameter is dependent on the consumption of fuel that is 1 to 3 inches. The rationale is that if over 90 percent of the larger fuel is consumed, conditions must be right to burn all of the smaller fuel. Otherwise only 90 percent of the smaller fuel is burned. The consumption of 1 to 3 inches fuel depends on the moisture content of the

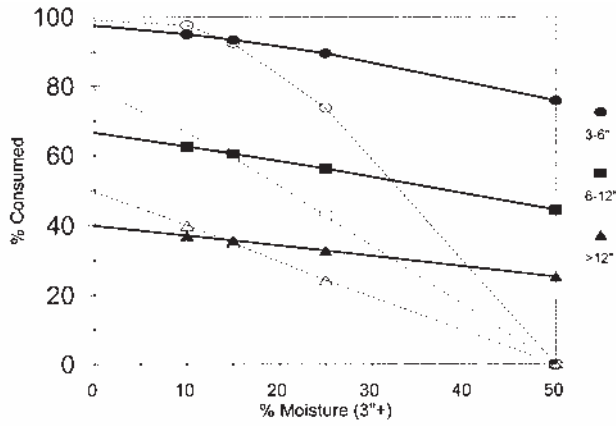

Figure 2.19—Predicted fuel consumption for large woody fuel (> 3") for different size classes and moisture contents. The points on the graph indicate the four default fuel moisture conditions. The solid lines and symbols are for the naturally occurring fuel, while the dotted lines and open symbols are for fuel resulting from management activities.

smaller fuel rather than its own moisture content (fig. 2.20). Naturally occurring fuel in these size classes is consumed independently of moisture levels (65 percent for the 1 to 3 inches fuel and 90 percent for fuel less than 1 inch).

Litter and live fuel consumption in FFE is independent of their moisture content. The model assumes that 100 percent of litter and herbs and 60 percent of shrubs are consumed.

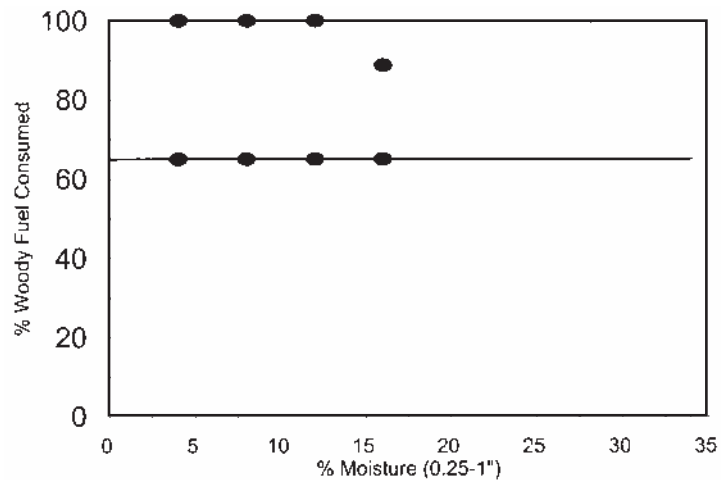

Figure 2.20—Predicted fuel consumption for 1 to 3 inches woody fuel for different moisture levels. The points on the graph indicate the values at the four default fuel moisture conditions. The solid line is for the naturally occurring fuel, while the dotted line is for fuel resulting from management activities. Notice that the consumption of larger fuel depends on the moisture values of the smaller fuel.

Mineral soil exposure is calculated by the model as a function of the burning of the duff layers (Brown and others 1985), which in turn is a function of the duff moisture content. If less than 10 percent of the duff layer is burned, then there will be no mineral soil exposure. Mineral soil exposure can have an impact on any automatic regeneration that is triggered in the following FVS cycle.

Fuel that has been piled burns differently (in general more completely) than unpiled fuel (section 2.5.3).

Smoke Production: Two categories of particulate matter emissions are calculated: less than 2.5 microns in diameter and less than 10 microns in diameter. Smoke production is calculated using a series of multipliers (emission factors) applied to the amount of fuel consumed in each size class (table 2.21; Reinhardt and others 1997). For duff and large woody fuel, these multipliers vary with moisture content.

2.5.6 Potential Fires

In addition to simulating a fire and its effects at a specified point in time, the FFE can also compute indicators of *potential* fire behavior and effects as they change over the simulation period. These provide an important method for assessing fuel and the associated fire hazard, as fuel and stand conditions change over time and with management actions.

For given wind and moisture conditions, fire intensity changes with the amount of fuel in the stand and with the likelihood of a full or partial crown fire. The FFE calculates the potential surface fire flame length, degree of crown fire activity (surface, passive crown fire, or active crown fire), tree mortality (percent stand basal area, and percent volume), and smoke production (fig. 2.21). Each of these is calculated for two sets of conditions. By default, the first set represents severe conditions that might represent wildfires (dry, windy) and the second represents moderate conditions that are more typical of prescribed fires. Conditions can be modified by the user.

Crown fires play an important role in the spread and impact of fires. Information about canopy fuel and the wind speed necessary to induce crowning under various scenarios is useful to fire and fuel managers. The model therefore reports the canopy base height, the canopy bulk density, the

Table 2.21—Emission factors (lb emission per ton of fuel consumed) used to calculate smoke emissions. Emission factors for some fuels vary with moisture content, others are constant.

		Particulate Matter < 2.5 microns			Particulate Matter < 10 microns		
		wet	moist	dry	wet	moist	Dry
Surface woody fuels	Litter	7.9			9.3		
	0-0.25"	7.9			9.3		
	0.25-1"	7.9			9.3		
	1-3"	11.9			14.0		
	3+"	22.5	18.3	16.2	26.6	21.6	19.1
	Duff	23.9	25.8	25.8	28.2	30.4	30.4
Live	Herbs & shrubs	21.3			25.1		
	Canopy fuels	21.3			25.1		
	Piled fuels	17.0			20.0		

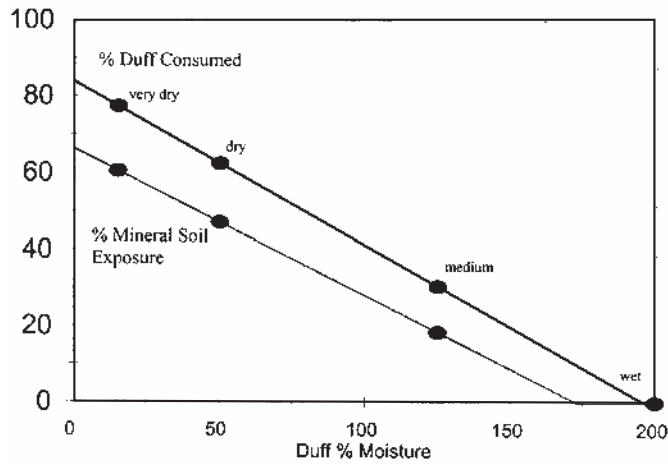

Figure 2.21—Relationship between duff consumption, mineral soil exposure, and duff moisture levels. The points on the graph indicate the four default fuel moisture conditions. Duff consumption depends on duff moisture and mineral soil exposure is a function of duff consumption.

torching index, and the crowning index. The predicted values change over time and can be affected by management activities (fig. 2.22, 2.23).

All information about potential fires is calculated using the same methods that are used for calculating the simulated fires. Thus, if a fire with the same wind, temperature, and moisture conditions is scheduled in the same year that the potential information was calculated, the simulated flame length and basal area mortality would be the same as shown in the potential fire report.

Users can control the frequency with which this information is calculated (**POTFIRE** keyword) and the wind, temperature, and moisture conditions that are used for the potential severe and moderate calculations (**POTFWIND**, **POTFTEMP** and **POTFMOIS** keywords).

2.5.7 Output

At the time of a fire, several output tables can be printed that give more information about the effect of the fire on trees and fuel and confirm the parameters that were set for the fires. Each of these tables is optional and must be requested using a keyword. An additional output file that reports the potential intensity and effect of fires under two sets of conditions can also be produced.

Burn Conditions Report: At the time of a fire, the moisture conditions and wind speed play a role in the intensity and effect of the fire. The burn conditions output table allows users to check the moisture conditions and slope (both originally set by the user) and to see the mid-flame wind speed, flame length, and scorch heights that were calculated by the model (table 2.22). The columns of the table are:

Year	The year of the burn.
Percent Moisture	The percent fuel moisture.
1 hr	0 to 0.25 inch fuel
10 hr	0.25 to 1 inch fuel
100 hr	1 to 3 inches fuel
3+	3 inches+ fuel
Duff	duff
Live	Live fuel

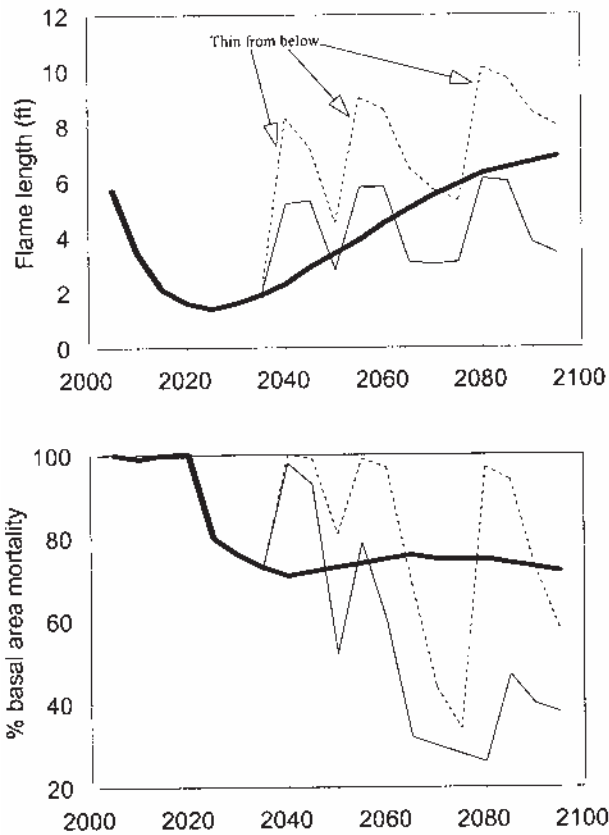

Figure 2.22—Potential flame length and mortality in a stand under three management scenarios. The stand is established at the beginning of the run. In one scenario no treatment was applied (thick line). In two scenarios the stand was thinned from below (in 2040, 2055 and 2080). In one scenario the harvested material was left on the ground causing an increase in surface fuels, and thus in potential flame length and mortality (dotted line) and in the other scenario it was all removed (thin line). Even when activity fuels are removed, flame length increases temporarily after thinning because reductions in canopy closure cause an increase in midflame windspeed.

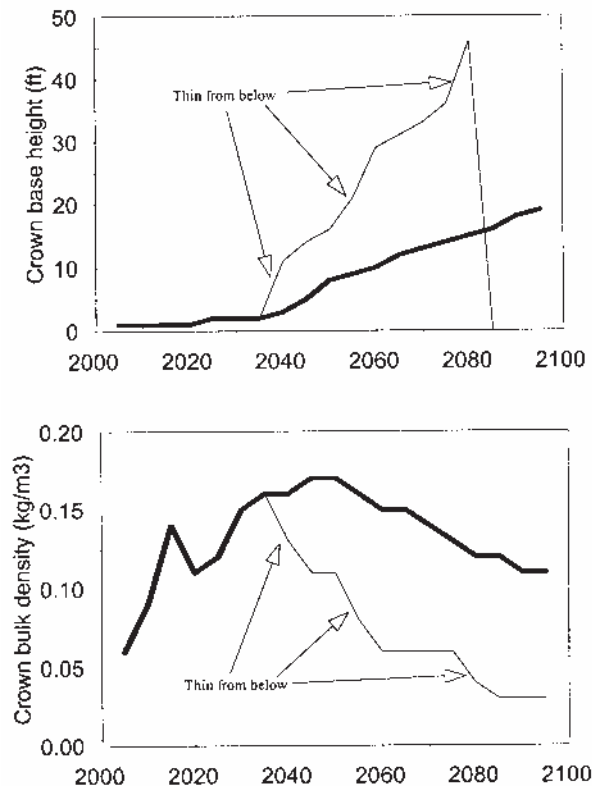

Figure 2.23—Canopy base height and bulk density under different management scenarios. A mixed-conifer stand is established at the beginning of the simulation (thick line). In one scenario this stand is repeatedly thinned from below (thin line). The canopy fuel is independent of whether the harvested material is removed or left in the stand.

Table 2.22—Example burn conditions report. This report shows that in the year 2065 the fuels were most like a fuel model 10, with some characteristics of a fuel model 12. The simulated fire was an active crown fire.

```

-----
                ***** FIRE MODEL VERSION 1.0 *****
          BURN CONDITIONS REPORT -- CONDITIONS AT THE TIME OF THE FIRE
-----
                MIDFLAME          FLAME SCORCH          FUEL MODELS
                -----          -----          -----
                % MOISTURE          WIND SLOPE          LENGTH HEIGHT          MOD %WT MOD %WT MOD %WT
YEAR  1HR 10HR 100HR  3+ DUFF LIVE (MPH) (%)          (FT) (FT)  FIRE TYPE          MOD %WT MOD %WT
-----
2065   4.   4.   5.  10.  15.  70.  2.9   20   75.3 374.7  ACTIVE          10  80  12  20
-----

```

Mid-flame wind	The mid-flame wind speed (mph) calculated based on the user-defined 20-foot wind speed and the canopy closure of the stand.
Slope	The percent slope of the stand. This is part of the basic stand information. It is included in this report because it is one of the factors that determine flame length.
Flame length	The flame length (ft) that will be used for calculating tree mortality.
Scorch height	The scorch height (ft), based on the flame length.
Fire Type	Surface, passive or active crown fire.
Fuel model	Fire behavior fuel models and their weights.

This output file can be requested using the keyword **BURNREPT**. Use this output to make sure you are simulating the fire as you intended, and to document simulated fire treatments.

Fuel Consumption Report: When fires occur, this table reports the amount of fuel consumed in each size class, the mineral soil exposure, and the amount of smoke produced (table 2.23). The columns of the table are:

Year	The year of the fire.
Percent Mineral Soil Exposure	
Fuel Consumed	(tons per acre)
Litr	Litter
Duff	
0 to 3 inches	Small woody fuel less than 3 inches diameter.
3 inches+	Large fuel. This is the sum of the next three columns in the table.
3 to 6 inches	
6 to 12 inches	
12 inches+	
Herbs and Shrubs	
Crown	The amount of crowns consumed through crown scorching or crown fires.
Total	The total amount of fuel consumed. This column is the sum of the litter, duff, small, and large fuel as well as the herbs, shrubs, and crowns. It corresponds to the column labeled "TOTAL CONS" in the all fuels report.
Percent Consume	Percent of the available fuel in the following two categories that was consumed.

Table 2.23—Example fuel consumption report. The total consumption reported here is the same as on the detailed fuel report (table 4.9).

```

-----
***** FIRE MODEL VERSION 1.0 *****
FUEL CONSUMPTION & PHYSICAL EFFECTS REPORT
-----
PERCENT          FUEL CONSUMED (TONS/ACRE)          %          SMOKE
MINERAL-----
SOIL
YEAR EXPOSUR  LITR  DUFF  0-3"  3"+  3-6"  6-12"  12"+  HERB&  TOTAL  %CONSUME  TREES  SMOKE
          LITR  DUFF  0-3"  3"+  3-6"  6-12"  12"+  SHRUB  CRWNS  CONS.  DUFF  3"+  WITH  PRODUCTION
          LITR  DUFF  0-3"  3"+  3-6"  6-12"  12"+  SHRUB  CRWNS  CONS.  DUFF  3"+  CRWNG  (TONS/ACRE)
          LITR  DUFF  0-3"  3"+  3-6"  6-12"  12"+  SHRUB  CRWNS  CONS.  DUFF  3"+  CRWNG  <2.5  < 10
-----
2065   60     1.3   8.9   4.8  16.9  10.4   6.0   .5    .5   19.3  51.7   77   77   100   .43   .51
-----

```

- Duff Percent duff and large woody fuel consumption can be an indicator of fire severity.
- 3 inches+
- Smoke Production The amount (tons/acre) of smoke produced in two different categories.
- Less than 2.5 Smoke particles less than 2.5 microns in diameter. These tiny particles are considered respirable, and thus have implications to human health.
- Less than 10 Smoke particles less than 10 microns in diameter (this value includes smoke less than 2.5 microns).

This table can be requested using the **FUELREPT** keyword.

Fuel consumption is an important indicator of fire severity. This report can be used to document simulated fire effects.

Mortality Report: A complete report on the percent of trees by species and size class that were killed by fires in a given year can be produced using the **MORTREPT** keyword (table 2.24). This report is created only in years a fire occurs. The table contains the following fields.

- Year The year of the fire.
- SP Two-letter species code. Only species in the current stand will be listed.

Number Killed / Number before

In each column, the value to the right of the “/” are the number of trees that were killed (trees per acre) and the value to the right of the “/” are the number of trees in that size class and species that were present before the fire. This information can be used to easily tell what sizes and species of trees were killed as well as the relative susceptibility of different categories.

- 0.0 to 5.0
- 5.0 to 10.0
- 10.0 to 20.0
- 20.0 to 30.0
- 30.0 to 40.0
- 40.0 to 50.0
- Greater than=50.0

- Basal Area Total basal area killed, ft²/acre
- Total Cu Ft Total volume killed, ft³/acre

Table 2.24—Example report for fire-based mortality. In this simulation all trees were killed.

```

-----
***** FIRE MODEL VERSION 1.0 *****
MORTALITY REPORT
-----
YEAR  SP      .0- 5.0    5.0-10.0    10.0-20.0    20.0-30.0    30.0-40.0    40.0-50.0    >=50.0    BASAL    TOTAL
      SP      .0- 5.0    5.0-10.0    10.0-20.0    20.0-30.0    30.0-40.0    40.0-50.0    >=50.0    AREA    CU FT
-----
2065  L         1/      1
      DF    165/   165    79/   79    127/  127    6/    6    0/    0    0/    0    0
      GF    42/    42
      LP     6/    6    12/   12    3/    3
      S     7/    7
      AF   139/  139
      ALL  363/  363    91/   91    131/  131    6/    6    0/    0    0/    0
                                         .14      1
                                         175.93  5733
                                         .07      0
                                         7.03    320
                                         .04      0
                                         .20      1
                                         183.41  6058
-----

```

This report allows users to examine in detail the impact of a simulated fire on a stand. It can be used to iteratively develop a burn prescription that achieves desired levels of tree mortality. It can also be used to gain insight into the expected effects of fire on a particular stand.

Potential Fire Report: The potential fire report gives information about the potential impact of fires under two sets of conditions. By default, these conditions represent extreme and moderate fire conditions, but users can select any sets of conditions they choose (section 2.5.6). The report can be produced at any interval using the **POTFIRE** keyword (table 2.25). The columns of the report are:

Year	The year of the fire.
Flame Length	The potential flame length (ft)
Condition 1	under condition set 1 (severe conditions)
Condition 2	under condition set 2 (moderate conditions)
Type of Fire	Surface, Passive or Active Crown Fire
Condition 1	under condition set 1
Condition 2	under condition set 2
Torching index	The 20-ft wind speed (miles/hour) required to cause torching of some trees under condition set 1.
Crown index	The 20-ft wind speed (miles/hour) required to cause an active crown fire under condition set 1.
Canopy base height	The height (ft) of the base of the canopy.
Canopy bulk density	The bulk density of the canopy (kg/m ³).
Potential Mortality	The potential tree mortality as measured by two different indicators for both fire conditions:
Percent BA 1	percent of the basal area that would be killed under condition set 1 or 2.
Percent BA 2	
VOL 1	total volume (cubic feet) that would be killed under condition set 1 or 2.
VOL 2	
Potent Smoke	The potential amount of smoke emissions (tons per acre) less than 2.5 microns.

Condition 1	under condition set 1
Condition 2	under condition set 2
Fuel Models	The fire behavior fuel models that are used in the weighting scheme. Up to four such fuel models may be shown, but normally only one or two are present. If the static option is in effect, only one fuel model will be shown.
Mod	A fuel model
Percent wt	The percent weighting for that model. These should sum to 100, but may not due to rounding

Values of -1 are printed for canopy base height, torching index and crowning index if canopy fuels are so sparse that the canopy base height is undefined (section 2.4.7).

This report provides a way to assess stand and fuel conditions, as well as proposed management, in terms of expected fire behavior and effects. Examining the potential mortality columns, for example, gives insight into the changing vulnerability of a stand to stand-replacement fire over time. Comparing this report from a no-management simulation and simulations with a variety of treatment alternatives provides a way of assessing treatments in terms of their impact on fire hazard. For example, a goal of management might be to reduce the likelihood of crown fire. Crown fire potential depends on both surface and canopy fuels. A number of treatments might be simulated to compare the effectiveness of prescribed fire, surface fuel management, and thinning in reducing the likelihood of crowning.

Table 2.25—Example potential fire report. Changes in fuels are reflected in the flame length (which also affects mortality) and type of fire. Changes in stand structure are reflected in the canopy base height and canopy bulk density. Active crown fires always have 100 percent mortality.

```

***** FIRE MODEL VERSION 1.0 *****
POTENTIAL FIRE REPORT
-----
FIRE          WIND  TEMP  FUEL MOISTURE  CONDITIONS (PERCENT)  -----
CONDITION    (MPH)  (F)  0-0.25"  0.25-1"  1-3"  3"+  DUFF  LIVE
SEVERE       20.0  70   4.       4.       5.    10.  15.   70.
MODERATE     6.0   70  12.      12.      14.   25.  125.  150.
-----
          FLAME LENGTH  TYPE OF FIRE  TORCH  CROWN CNPY  CANPY  POTENTIAL MORTALITY  POTEN. SMOKE
          SEVERE MODER  SEVERE  MODERATE  SEVERE SEVERE HT  DENSITY  SEV.  MOD.  SEV.  MOD.  SEV.  MOD.
YEAR  FT      FT      MI/HR  MI/HR  FT  KG/M3  %BA  %BA  (TOT CU VOL)  (T/A <2.5)  MOD %WT MOD %WT MOD %WT MOD %WT
-----
1993  1.5    .7  SURFACE SURFACE  132.7  15.2  18  .168  34  34  996  996  .18  .11  8  86  10  14
1995  2.2    .9  SURFACE SURFACE  106.4  15.2  18  .168  34  34  996  996  .20  .13  8  70  10  30
2000  3.5    1.4 SURFACE SURFACE  79.3  16.5  19  .152  32  32  1025  1023  .25  .17  10  63  8  37
2005  5.5    2.4 SURFACE SURFACE  49.2  15.7  20  .161  35  30  1146  1046  .32  .22  10  80  12  20
2010  6.0    2.7 SURFACE SURFACE  51.4  15.3  22  .167  34  29  1184  1064  .37  .26  10  64  12  36
2015  5.9    2.6 SURFACE SURFACE  54.5  13.8  23  .190  33  28  1209  1079  .36  .25  10  67  12  33
2020  5.8    2.6 SURFACE SURFACE  57.7  13.4  24  .197  32  27  1236  1101  .36  .25  10  69  12  31
2025  5.8    2.5 SURFACE SURFACE  63.8  13.1  26  .204  30  26  1241  1113  .35  .24  10  72  12  28
2030  5.7    2.5 SURFACE SURFACE  69.9  12.9  28  .207  28  24  1223  1120  .34  .24  10  74  12  26
2035  5.7    2.5 SURFACE SURFACE  73.5  12.6  29  .213  25  23  1187  1123  .34  .23  10  76  12  24
2040  5.6    2.4 SURFACE SURFACE  79.8  12.4  31  .217  23  22  1157  1126  .33  .23  10  77  12  23
2045  5.6    2.4 SURFACE SURFACE  83.3  12.3  32  .219  22  21  1132  1124  .33  .23  10  78  12  22
2050  5.5    2.4 SURFACE SURFACE  89.9  12.1  34  .224  20  20  1119  1118  .33  .22  10  79  12  21
2055  5.5    2.4 SURFACE SURFACE  93.4  12.1  35  .222  19  19  1109  1109  .33  .22  10  80  12  20
2060  75.4   2.4 ACTIVE SURFACE  .0  12.1  3  .224  100  19  5857  1105  .43  .32  10  80  12  20
2065  75.3   2.4 ACTIVE SURFACE  2.8  12.0  4  .226  100  18  6058  1097  .43  .32  10  80  12  20
2070  13.0   5.4 SURFACE SURFACE -1.0 -1.0 -1  .000  100  100  0  0  .37  .28  12  92  10  8
2075  14.1   5.9 SURFACE SURFACE -1.0 -1.0 -1  .000  100  100  0  0  .45  .34  12  81  13  19
2080  15.3   5.3 PASSIVE PASSIVE  .0  89.5  1  .015  99  99  6  6  .47  .35  12  79  13  21
2085  15.7   4.9 PASSIVE PASSIVE  .0  63.5  1  .024  99  99  32  32  .49  .36  12  78  13  22
2090  17.7   4.7 PASSIVE PASSIVE  .0  50.4  1  .034  99  99  112  112  .50  .37  12  76  13  24
2095  26.1   4.5 PASSIVE PASSIVE  .0  37.1  1  .052  99  99  285  285  .50  .38  12  80  13  20

```

The potential fire report is produced before the impacts of any fires are simulated. Thus, the conditions of the stand are the same when calculating the potential impacts and any actual impacts. If the environmental variables (wind, temperature, and moisture) are the same for the potential fire as for the simulated fire, the simulated fire should produce the impacts predicted by the potential fire report.

2.6 Discussion

2.6.1 Model Contributions

FFE-FVS is a tool for managers. It has a broad geographic scope encompassing most of the Western United States. A broad range of management actions – silvicultural as well as prescribed fire and mechanical fuel treatment – can be simulated. FFE-FVS provides an extensive set of outputs that allow forest management decisions to be assessed in a temporal context: not only short-term effects on fuels, stand dynamics, and potential fire behavior are modeled, but also the way in which these interacting ecosystem components may be expected to change over time.

Perhaps the most important contribution of this model is to explicitly link stand and fuel dynamics. A simulation tracks the biomass, growth, and mortality of individual trees in a stand; litterfall from the living trees and falldown of the snags determine surface woody fuel loads. Fire, if simulated, impacts surface fuels directly by consuming them, indirectly, over time, as fire-killed trees fall to the ground, and, even more indirectly, by impacting future stand structure.

Recent research on potential for crown fire behavior is linked in this model with dynamically computed canopy fuel characteristics. With or without management, canopy fuels change over time. Because FVS already tracked crown characteristics of the individual trees making up the stand over time (including ingrowth), it provides a natural vehicle for assessing changing crown fire hazard.

Many of the components of FFE-FVS have long histories in both scientific and management communities. For example, Rothermel's surface fire model, included here, was first presented in 1972 and has been in widespread use ever since. Both modelers and users have gained a good understanding of its robustness as well as its limitations and are comfortable interpreting its output. This is also true of the growth and yield algorithms that drive FVS.

2.6.2 Model Limitations

FFE-FVS has a number of weaknesses. One problem is that the base model, FVS, simulates growth and mortality using cycles of typically 10 years. The FFE operates on a 1-year time step. Sometimes this can lead to model behavior that is an artifact of cobbling together the two time steps and is not an intended representation of a real phenomenon. Snag numbers, for example, tend to exhibit a saw-toothed pattern, with sharp increases at cycle boundaries when all the cycle's natural mortality is added, and gradual declines between, as snag fall-down occurs. Choosing short cycle lengths or reporting indicators only at cycle boundaries can somewhat compensate for this problem.

Discontinuous behavior is particularly evident in indicators that depend in part on canopy base height – canopy base height itself, torching index, potential tree mortality, and fire type. In this case the underlying processes probably are discontinuous – regeneration often occurs in pulses, a stand suddenly passes a critical point after which vulnerability to torching sharply increases or decreases. These intended discontinuities are probably exaggerated by the fact that in the model, all regeneration occurs on cycle boundaries, as well as all natural tree mortality. Self-pruning and mortality of suppressed understory trees may cause the stand’s canopy base height to increase sharply at a cycle boundary, or in-growth may cause the canopy base height to fall abruptly.

Within a year, users cannot control the order of simulated management actions.

Live fuels (herbaceous plants and shrubs) are poorly represented in FFE-FVS. Their biomass and its contribution to fuel consumption and smoke are only nominally represented as a fixed amount that depends on percent cover and dominant tree species. Live fuels can contribute significantly to the behavior of a fire. Their contribution to fire behavior is represented in the selection of fire behavior fuel models. Canopy cover, overstory composition, habitat type, and stand history influence selection of fire behavior fuel models. Live fuels are not dynamically tracked and simulated in FFE-FVS.

Decomposition rates are not sensitive to aspect, elevation, or potential vegetation type in FFE-FVS. Decomposition rates can be controlled by the user, however, so it is possible for a knowledgeable user to “tune” the decomposition algorithms and, thus, the fuel dynamics.

Fire conditions (fuel moisture and wind speed) must be selected by the user. FFE contains no climatologic data and will not estimate site-specific moistures. If you want to look at differences in fire dynamics between north and south slopes, for example, you must be able to give the model different fuel moistures for the different sites.

These limitations suggest opportunities for further research and model development. In the meantime, we designed FFE so that its commands allow users to apply any information they have to their specific situation. Users can overcome many of these limitations and customize the model by careful use of the keywords.

Nicholas L. Crookston
Donald C.E. Robinson
Sarah J. Beukema



Chapter 3

User's Guide

Abstract—The Fire and Fuels Extension (FFE) to the Forest Vegetation Simulator (FVS) simulates fuel dynamics and potential fire behavior over time, in the context of stand development and management. This chapter presents the model's options, provides annotated examples, describes the outputs, and describes how to use and apply the model.

Keywords: FVS, FFE, forest fire, stand dynamics, FOFEM, BEHAVE, snags, coarse woody debris

3.1 Introduction

The Fire and Fuels Extension to the Forest Vegetation Simulator (FFE-FVS) is introduced in chapter 1, "Purpose and Applications," and chapter 2, "Model Description," covers the model's content. Features customized for various geographic regions are described in chapter 4, "FFE Variants." Here, the subject is how to use the FFE-FVS. We start with the simplest form of a run, show how to change the initial values, set fires, adjust the snag and fuel parameters, specify management actions, and control the generation of outputs. (See chapter 2 for a detailed explanation of the output tables.) This current chapter also presents information on using the FFE-FVS with the Event Monitor (Crookston 1990), a feature of FVS that allows for scheduling activities predicated on conditional statements.

This chapter assumes that you already know how to use the Forest Vegetation Simulator (Wykoff and others 1982), that you have the FFE-FVS software installed on your computer, and that you know how to start the program. Instructions for getting this program and accessing the background information you need are printed on the inside front cover of this volume.

We assume that you will use a text editor to prepare and edit your keyword files and that your tree data files are already prepared. If you are using Suppose (Crookston 1997), you can readily apply what is presented here. Suppose is kept up to date with respect to changes in keywords, the model, and default parameter values.

3.2 Simple Run

The example used in the preface paper is used to illustrate how to run the FFE-FVS. We start with the basic keyword fire needed create a *no fire* and *no management* run of FVS (fig. 3.1). The necessary tree data file is shown in figure 3.2.

To make FFE run, only two keywords need to be added to those illustrated in figure 3.1. FMIN signals the start of the FFE keywords, and END signals the end. However, unless another keyword is added, the FFE will not provide any output and nor simulate any fires or effects. In short, you need at least one additional keyword.

- FMIN** Signals the start of the FFE keywords.
- END** Signals the end of the FFE keywords. All other FFE keywords must appear between the FMIN-END pair. You may code several FMIN-END pairs and you may have one or many FFE keywords between each pair. The sequence may appear anywhere in the keyword file prior to the **PROCESS** keyword (line 16, fig. 3.1).

Several keywords are used to request output reports, set initial values, simulate fuel and fire management actions and otherwise control the model. Figure 3.3 shows how the keyword file from figure 3.1 is modified to request an FFE run and, using **POTFIRE** keyword, the Potential Fire Report output. This keyword is fully described later in section 3.8 Output. The important feature of figure 3.3 is the set of keywords inserted between lines 11 and 12. Exactly the same method is used in all of the examples.

Line Number	Column ruler
	----+----1----+----2----+----3----+----4----+----5----+----6----+----7----+----
1	StdIdent
2	300290024601 Stand 300290024601 at Flathead FIA Data
3	Screen
4	InvYear 1993
5	StdInfo 110 692 84 243 20 53
6	Design 0 1 999 1 0 6104
7	Growth 1 10 1 10 10
8	SiteCode 3 54
9	TimeInt 5
10	TimeInt 1 7
11	NumCycle 21
12	Open 2
13	02900246.tre
14	TreeData 2
15	Close 2
16	Process
17	Stop

Figure 3.1—Keyword file used to make a *no fire* and *no management* run of FVS. The user's guide examples are illustrated by showing how this basic keyword file is modified to include FFE keywords. Note that not all of these keywords are critical to the execution of a basic run; their use ensures that the simulation will produce better results.

Line Number	Column ruler													
	----	1	----	2	----	3	----	4	----	5	----	6	----	7
1	101	14.851DF	84	0	52	0226	027	0	0	021	0	0		
2	102	42.861DF	44	0	38	02556127	0	0	021	0	0			
3	103	42.861DF	35	0	31	02556127	0	0	031	0	0			
4	104	42.861DF	30	0	23	01556127	0	0	031	0	0			
5	201	38.751DF	52	0	32	0527	0	0	0	021	0	0		
6	301	12.381DF	92	0	62	0426	027	1	0	021	0	0		
7	302	2.811DF	193	0	77	0426	82712	0	021	0	0			
8	303	23.341DF	67	0	48	0226	027	0	0	021	0	0		
9	304	22.746LP	96	96	63	00	2	32635275021	0	0	0			
10	401	36.286LP	76	76	63	00	2	3263527	021	0	0			
11	402	5.841DF	134	0	74	04	0	0	0	0	021	0	0	
12	403	19.661LP	73	0	64	02	0	0	0	0	021	0	0	
13	404	9.151DF	107	0	70	025572	0	0	0	021	0	0		
14	405	58.206LP	60	60	60	00	2	3	0	0	021	0	0	
15	406	56.316LP	61	61	53	00	2	3	0	0	021	0	0	
16	501	18.631DF	75	0	69	045577	0	0	0	021	0	0		
17	502	11.371DF	96	0	76	04	0	0	0	0	021	0	0	
18	503	26.401DF	63	0	50	015574	0	0	0	021	0	0		
19	504	8.061DF	114	0	73	02	0	0	0	0	021	0	0	
20	505	36.286LP	76	76	68	00	2	3	0	0	021	0	0	
21	506	60.196LP	59	59	59	00	2	3	0	0	021	0	0	
22	507	33.411LP	56	0	68	01	0	0	0	0	021	0	0	
23	508	42.861DF	14	0	19	015561	0	0	0	021	0	0		
24	601	37.301DF	53	0	41	03	0	0	0	0	021	0	0	
25	602	0.731DF	379	0	97	045574	0	0	0	021	0	0		
26	603	2.441DF	207	0	88	04	0	0	0	0	021	0	0	
27	701	9.501DF	105	0	49	035579	0	0	0	021	0	0		
28	702	18.141DF	76	0	46	03	0	0	0	0	021	0	0	
29	703	19.131DF	74	0	45	015561	0	0	0	021	0	0		
30	704	2.181DF	219	0	82	04	0	0	0	0	021	0	0	
31	705	42.861L	18	0	22	015561	0	0	0	021	0	0		

Figure 3.2—Tree data file, 02900246.tre, referred to in line 13 of figure 3.1. These tree data are used with all of the examples.

Line Number	Column ruler															
	----	1	----	2	----	3	----	4	----	5	----	6	----	7	----	8
	Keyword	Field 1	Field 2	Field 3	Field 4	Field 5	Field 6	Field 7								
1	StdIdent															
2	300290024601	Stand	300290024601	at	Flathead	FIA	Data									
3	Screen															
4	InvYear	1993														
5	StdInfo	110	692	84	243	20	53									
6	Design	0	1	999	1	0	6104									
7	Growth	1	10	1	10	10										
8	SiteCode	3	54													
9	TimeInt		5													
10	TimeInt	1	7													
11	NumCycle	21														
FFE 1	Fmin															
FFE 2	PotFire															
FFE 3	End															
12	Open	2														
13	02900246.tre															
14	TreeData	2														
15	Close	2														
16	Process															
17	Stop															

Figure 3.3—The keyword file used to make a *no fire* and *no management* run of FVS (fig. 3.1) is modified to run the FFE (line FFE 1) and to generate the Potential Fire report (line FFE 3; more information on this keyword is presented in section 3.4.4).

3.3 Initializing the Model

The FFE dynamically tracks snags by species, 2-inch diameter class, and hardness. Fuel is tracked by size class. While some default values are present in the model to initialize fuel loads, your projection will be better if you enter values appropriate for your stand.

You can initialize the number of snags using two different methods, separately or in combination. First, trees that are recorded as recent mortality in the FVS tree data file (fig. 3.2) are made into snags in the FFE. Those snags are always considered hard unless the **SNAGPSFT** keyword is used to change the proportion of snags that are soft at the time of death (see section 3.5.3). In addition, you can specify the number of hard and soft snags by species and diameter class using one or more **SNAGINIT** keywords.

SNAGINIT Add a snag to the snag list. Use as many of these keywords as you need to enter the data that represent your stand.

- Field 1: Species number or letter code; entry is required.
- Field 2: Diameter at breast height (DBH) at the time of death (inches); entry is required.
- Field 3: Height at the time of death (feet); entry is required.
- Field 4: Current height (feet); entry is required.
- Field 5: Number of years the tree has been dead.
- Field 6: Number of snags per acre with these characteristics; entry is required.

Initial dead fuel loads depend on the variant, the cover type of the stand, and the percent cover of the stand. However, you can set the initial amount of dead fuel using the **FUELINIT** keyword. Live fuel loads include the weights of herbs, shrubs, and grasses, but you cannot adjust or initialize those fuels.

FUELINIT Set the amount of dead fuel in each fuel size class. Values left blank are replaced with variant-dependent defaults shown in the section 2.4.2 of chapter 2, “Model Description,” and in the documentation for the individual variants.

- Field 1: Initial fuel load for fuel 0 to 1 inch (tons per acre).
This loading gets divided equally between the 0 to 0.25 inch class and the 0.25 to 1 inch class.
- Field 2: Initial fuel load for fuel 1 to 3 inches (tons per acre).
- Field 3: Initial fuel load for fuel 3 to 6 inches (tons per acre).
- Field 4: Initial fuel load for fuel 6 to 12 inches (tons per acre).
- Field 5: Initial fuel load for fuel greater than 12 inches (tons per acre).
- Field 6: Initial fuel load for litter (tons per acre).
- Field 7: Initial fuel load for duff (tons per acre).

Figure 3.4 illustrates how to enter initial snag and fuel values. The **SNAGINIT** keywords are used to create five Douglas-fir snags between 30 and 32 inches, 10 grand fir snags between 20 and 25 inches, and three lodgepole pine snags of 15 inches. The trees that created these snags died 12 years prior to the inventory year of the stand, and their heights are all lower than they were originally. In the example, each species is grouped using a

Line Number	Column ruler							
	-----1-----	-----2-----	-----3-----	-----4-----	-----5-----	-----6-----	-----7-----	-----8
	Keyword	Field 1	Field 2	Field 3	Field 4	Field 5	Field 6	Field 7
1-11	See figure 3.1							
FFE 1	Fmin							
FFE 2	PotFire							
FFE 3	SnagInit	DF	31	82	52	12	5	
FFE 4	SnagInit	GF	23	72	58	12	10	
FFE 5	SnagInit	LP	15	65	43	12	3	
FFE 6	FuelInit			3.5	5.2	8.5		
FFE 7	End							
12-17	See figure 3.1							

Figure 3.4—The keyword file presented in figure 3.1 further modified to initialize snags (in addition to those that could be in the sample tree data file) and dead fuel loads.

single keyword that defines the average characteristics. Alternatively, the exact characteristics of each of the 18 snags could have been entered using the **SNAGINIT** keyword 18 times. Because snags end up grouped into classes with an average diameter and height (see chapter 2, “Model Description”), it is unlikely that the extra effort would produce substantially different results. Initial fuel loads are set to: 3.5 tons per acre in the 3 to 6 inch category, 5.2 tons per acre in the 6 to 12 inch category, 2.1 tons per acre of fuels 12 to 15 inches, and some downed large logs that were about 6.4 tons per acre. Note that the “8.5” in Field 5 is the sum of all the large material because the FFE does not track these separately. The model uses default values for size classes that are not entered.

3.4 Fires

3.4.1 Introduction

FFE-FVS can simulate fire and its effects three ways: simulated fires, pile burns, and potential fires. *Simulated fires* compute fire effects and apply them to the stand, creating snags and changing the state of the fuel and trees for the next time step. These fires simulate forest fires regardless of the method of ignition or policy regarding suppression.

A second way is to simulate *burning piles* of fuel. The model predicts the smoke produced and the reduction of fuel and allows you to specify the percentage of trees killed during the treatment. This method is a simple way to simulate a fuels treatment.

In the third way, the model simulates *potential fires*. All the calculations for simulated fires are done except that the effects are not applied to the fuels and stand; changes in those values are computed as if no fire occurred. When the Potential Fire Report is being generated, as done using the keywords shown in figure 3.1, information about potential fires is frequently computed, perhaps every year of projected time. In contrast, information about *simulated fires* is only computed when the simulated fires are scheduled to burn.

When you *simulate fires* or use the model to compute *potential fires*, you can set the environmental conditions and several other parameters that control how the model simulates the fires. Keywords used to control the simulated fires are presented next (section 3.4.2), followed by pile burning

(section 3.4.3), potential fires (section 3.4.4), and last, are keywords used to control the fuel model selection that is common to both simulated and potential fires (section 3.4.5).

3.4.2 Simulated Fires

A fire is simulated in each year the **SIMFIRE** keyword is scheduled, since the FFE-FVS model does not predict when a fire will occur. This keyword actually serves two purposes. The main purpose is implied by its name, which is to signal when a fire is simulated. The second purpose is to specify some of the environmental conditions in place at the time of the fire. The environmental conditions at the time of a fire play a big role in the intensity of the fire, and therefore in the mortality of the trees and the consumption of fuel. Some of the environmental conditions can be set using the **SIMFIRE** keyword. Fuel moisture conditions are set using the **MOISTURE** keyword. Note that fuel consumption is dependent on fuel moisture, not on the flame length, wind speed, or temperature. Drier fuel burns more completely and more mineral soil may be exposed. Dry duff produces more smoke than wet duff, while the reverse is true for large fuels. Smoke production from all other fuels is not dependent on moisture. The flame length is also dependent on the moisture of small (less than 3 inch) fuel.

A keyword called **DROUGHT** also exists (see section 3.4.5) but it has no impact on the moisture content of fuels or on the fire conditions. In some variants, it affects the choice of fire behavior fuel model, which will affect fire intensity and mortality.

The last keyword in this group is called **FLAMEADJ**. It can be used to modify the flame lengths predicted by the model directly, in turn affecting the predicted fire effects. It is designed to provide a way to simply tell the FFE what flame lengths to use or how to modify those that the model predicts. Its purpose is to ensure that the FFE uses flame lengths that you expect. The **FLAMEADJ** keyword only applies to surface fires.

SIMFIRE Signal that a fire and its effects should be simulated and specify some of the environmental conditions for the fire. Use one **SIMFIRE** keyword for each fire you wish to simulate.

Field 1: The FVS cycle number or the calendar year; default is 1.

Field 2: Wind speed in miles per hour 20 feet above ground; default is 20.

Field 3: Nominal moisture levels as shown in table 3.1. If the **MOISTURE** keyword is used the value in this field is ignored; the default is 1=very dry.

Field 4: Temperature (°F); default is 70.

MOISTURE Set the moisture content for each fuel size class. These moisture values apply to simulated fires scheduled for the same calendar year. If this keyword is used for any size class, it must be used for all size classes because there are no default moisture conditions.

Field 1: The FVS cycle number or the calendar year; default is 1.

Field 2: Moisture value for 1 hour fuel (0 to 0.25 inch).

Table 3.1—Percent fuel moisture for the four nominal levels defined for field 3 of the SIMFIRE keyword.

Field 3 value	Name of moisture level	Fuel size class					
		0-2.5 inch (1 hour)	0.25-1 inch (10 hour)	1-3 inch (100 hour)	>3 inch	Duff	Live
1	Very dry	4	4	5	10	15	70
2	Dry	8	8	10	15	50	100
3	Moist	12	12	14	25	125	150
4	Wet	16	16	18	50	200	150

Field 3: Percent moisture for 10 hour fuel (0.25 to 1 inch).
 Field 4: Percent moisture for 100 hour fuel (1 to 3 inches).
 Field 5: Percent moisture for 3 inches+ fuel.
 Field 6: Percent moisture for duff.
 Field 7: Percent moisture for live fuel.

FLAMEADJ Modify or set the flame length for a fire simulated using the SIMFIRE keyword scheduled for the same year.

Field 1: The FVS cycle number or the calendar year; default is 1.

Field 2: Flame length multiplier. The default is 1.0, which is suggested for free-burning fires. We suggest using a value of 0.3 to simulate a throttle-back fire and 2.0 to simulate a mass-ignition fire.

Field 3: Enter a flame length to be used in place of a computed length. The default is for the model to compute the length and is signified by leaving the field blank or coding -1.

Field 4: Percent of crowns that burn (crowning). If blank or -1, the model computes the percent crowning.

Figure 3.5 shows the keywords for simulating two fires, a prescribed burn in 2002 and a wildfire in 2003. The prescribed fire is the first instance of the **SIMFIRE** keyword. Field 1 is used to specify the year and field 5 is used to signal that the default wind speed for prescribed fires be used. The other fields are left blank. The **MOISTURE** keyword is used to define the moisture values for the prescribed fire, indicated by using the same year in field 1 as

Line Number	Column ruler							
	1	2	3	4	5	6	7	8
	Keyword	Field 1	Field 2	Field 3	Field 4	Field 5	Field 6	Field 7
1-11	See figure 3.1							
FFE 1	Fmin							
FFE 2	SimFire	2002				1		
FFE 3	Moisture	2002	12	12	14	150	25	150
FFE 4	SimFire	2003	60	2	75	0		
FFE 5	End							
12-17	See figure 3.1							

Figure 3.5—The keyword file needed to simulate two fires, a prescribed fire in 2002 with specific moisture conditions and a wildfire in 2003 using more extreme conditions.

is used in field 1 of the first **SIMFIRE** keyword. The second use of the **SIMFIRE** keyword simulates a wildfire scheduled for 2003 with winds of 60 miles per hour, temperature of 75 °F, and “dry” moisture conditions.

Figure 3.6 illustrates using the **SIMFIRE** and **FLAMEADJ** keywords to simulate a low intensity fire. The **SIMFIRE** keyword is used with its default values and it is followed by the **FLAMEADJ** keyword where the flame length is set to 2.5 feet and the percent crowning is set to zero to eliminate any possibility of a crown fire.

3.4.3 Burning Piles

The **PILEBURN** keyword is used to simulate burning piled fuel in the stand. When used, it reduces fuels, estimates smoke production, and kills the proportion of trees you specify. No other fire effects are simulated.

The keyword has several options as listed below. Default conditions for pile burns and jackpot burns can be used simply by indicating either of these types of fuel burns on the keyword. In place of selecting one of the default types of burns, you can specify exact values for the parameters of the burn, or do both.

PILEBURN Signal that a pile or other concentration of fuel is to be burned.

Field 1: The FVS cycle number or the calendar year; default is 1.

Field 2: The index to the type of fuel burn where 1=pile burn and 2=jackpot burn; the default is 1. These values control the defaults for fields 3 through 5 on this keyword and otherwise have no special significance.

Field 3: Percent of the stand’s area affected by the treatment; the default is 70 when field 2 is 1=pile burn, and 100 for 2=jackpot burn.

Field 4: Percent of the fuel from the affected area in which the fuel is concentrated (area which will be treated); the default is 10 when field 2 is 1=pile burn, and 30 when it is 2=jackpot burn.

Field 5: Percent of the fuel from the affected area that is concentrated in the treated area; the default is 80 when field 2 is 1=pile burn, and 60 when it is 2=jackpot burn.

Field 6: Percent mortality of trees in the stand caused by this fuel treatment; default is 0.

Line Number	Column ruler						
	1	2	3	4	5	6	7
1-11	See figure 3.1						
FFE 1	Fmin						
FFE 2	SimFire	2002					
FFE 3	FlameAdj	2002	2.5	0			
FFE 4	End						
12-17	See figure 3.1						

Figure 3.6—The keyword file needed to simulate a low intensity fire with a specified flame length.

The default conditions imply a pile burn and can be interpreted as: 80 percent of the fuels from 70 percent of the stand are concentrated into piles that cover 10 percent of the stand's area. When these piles burn, no trees die. Since the FFE-FVS is a nonspatial model, the fuel is assumed to be evenly distributed across the stand both before and after the treatment. Thus, these percentages are simply used to determine how much of the fuel actually burns, and how much mineral soil will be exposed after the burn. For example, if there were 100 tons per acre of fuels in the stand excluding duff, the result of applying the default treatment would be to burn $0.8 \times 0.7 \times 100 = 56$ tons per acre. Then 10 percent of the duff would burn and 10 percent of the mineral soil would be exposed. Because of differential consumption rates, if the fuels include some that are larger than 1 inch, less than 56 tons per acre of fuel will actually be consumed by fire.

Line FFE 2 of figure 3.7 illustrates an example with a fuel treatment in year 2007. A total of 15 percent of the stand is actually burned, but it holds 75 percent of the fuel from 100 percent of the stand. Of the living trees, 1 percent are killed in this fuel treatment. Note that duff consumption only occurs on the 15 percent of the stand that contains the burn.

Nonpiled fuel treatments may be specified using combinations of the **SIMFIRE**, **FLAMEADJ**, and **MOISTURE** keywords. This approach implies that 100 percent of the fuels will be treated, but setting the moisture values of the different fuel pools, the flame lengths, or both provides for better control the consumption rates. For example, lines FFE 3 and 4 of figure 3.7 show how to use the **SIMFIRE** and **FLAMEADJ** keywords to simulate a fuel treatment in year 2037. The **SIMFIRE** keyword is used to create a fire that burns when there is no wind and with wet moisture conditions (field 3 has the value 4). The **FLAMEADJ** keyword sets the flame length and percent crowning both to zero, so no trees will be killed.

3.4.4 Potential Fires

As pointed out in section 3.4.1, the FFE can simulate *potential fires*, those where most of the model predictions are computed and output without actually applying any fire effects. The main output table for this option is the Potential Fire Report, described in section 2.5.7 of chapter 2, "Model Description." You control when calculations for the potential fires start and how often they are output using the **POTFIRE** keyword. This keyword's use is shown in figure 3.3, and its full description is in section 3.8, with the other

Line Number	Column ruler							
	-----1-----	-----2-----	-----3-----	-----4-----	-----5-----	-----6-----	-----7-----	-----8
	Keyword	Field 1	Field 2	Field 3	Field 4	Field 5	Field 6	Field 7
1-11	See figure 3.1							
FFE 1	Fmin							
FFE 2	PileBurn	2007		100	15	75	1	
FFE 3	SimFire	2037	0	4				
FFE 4	FlameAdj	2037	0	0				
FFE 5	End							
12-17	See figure 3.1							

Figure 3.7—This keyword file will simulate burning piled fuel in 2007 and a carefully controlled simulated fire in 2037 representing a prescribed burn.

keywords that control output. The model estimates two sets of values for the potential fires. One set uses moisture, temperature, and wind conditions that are consistent with *severe* fire conditions often associated with wild fires, and the other set corresponds to *moderate* conditions often associated with prescribed fire situations where the suppression policy or required level of action would be considered moderate or light.

You can specify the wind speed, temperature, and fuel moisture conditions for each of the two categories, known to the model as 1=severe and 2=moderate.

POTFWIND Set the wind speeds for the two categories of potential fire severity.

Field 1: The wind speed for the severe category; default is 20 miles per hour.

Field 2: The wind speed for the moderate category; default is 6 miles per hour.

POTFTEMP Set the temperature for the two categories of potential fire severity.

Field 1: The temperature for the severe category; default is 70 °F.

Field 2: The temperature for the moderate category; default is 70 °F.

POTFMOIS Set the fuel moisture conditions for the two categories of potential fire severity. The defaults for severe conditions correspond to the values for very dry moistures shown in table 3.1, and the defaults for moderate conditions correspond to the moist values.

Field 1: An index value that signals which of the two categories of fire the values in fields 2 through 6 apply where 1=severe and 2=moderate; 1 is the default.

Field 2: Percent moisture for 1-hour fuels (0 to 0.25 inch).

Field 3: Percent moisture for 10-hour fuels (0.25 to 1 inch).

Field 4: Percent moisture for 100-hour fuels (1 to 3 inches).

Field 5: Percent moisture for 3 inches+ fuels.

Field 6: Percent moisture for duff.

Field 7: Percent moisture for live fuels.

3.4.5 Fire Behavior Fuel Models

Calculations of flame length, for both the *simulated fires* and the *potential fires*, are done using Rothermel's 1972 fire behavior prediction system as implemented in FIREMOD (Albini 1976). This model requires a number of parameters that are not carried or readily calculated by the FFE. These include fuel characteristics such as surface-to-volume ratio, depth, and moisture of extinction, in addition to some parameters that are computed by the FFE, namely, the fuel loads by fuel size class. Thirteen stylized *fuel models* proposed by Anderson (1982) are used by the FFE in its adaptation of FIREMOD. How these fuel models are used and how they have been extended is covered in section 2.4.8 of chapter 2, "Model Description."

Briefly, the FFE picks one or more fuel models, calculates the fire intensity from each one, and then computes a weighted average flame length by interpolating using factors such as fuel loading or canopy cover. This interpolation provides flame lengths that change more gradually as stand conditions change than those that are computed without the interpolation logic.

By default, the model uses the interpolation method for calculating fire intensity, which we call using *dynamic* fuel models. If you prefer, however, you can tell the model to use only the fuel model it considers the best choice, rather than using the interpolation approach. This is done using the **STATFUEL** keyword.

Furthermore, you can define new fuel models, or change the parameters of existing models using the **DEFULMOD** (**DEF**ine **FUeL** **MOD**els) keyword. The purpose of this keyword is to give you the maximum control over the fire intensity calculations. The final keyword that controls the fire intensity calculations is the **FUELMODL** keyword. With it, you specify which fuel model(s) to use in any given year and specify the weights used in the interpolation logic in cases where more than one model is provided.

In some habitat or cover types, in a few FVS variants, the selection of the appropriate fuel model(s) depends on the weather conditions at the time of the selection. The **DROUGHT** keyword can identify one or more years as drought years, which may affect the fuel model selection and subsequent fire intensity. Consult the documentation for your variant to see if drought conditions are used. At the time the guide was written, the drought conditions were only used in the Utah and Central Rockies variants.

STATFUEL Signal that the *dynamic* interpolation logic not be used throughout the simulation.

DEFULMOD Modify the parameters of an existing fuel model or define the parameters of a new fuel model. Note that the defaults for fields 3 through 12 are those defined for the fuel models listed in table 3.2. Fields 8 through 12 are coded on a second line; each value in fields that are 10 columns wide starting in column 1. Even if these fields are not used, this additional line must be entered.

Field 1: The FVS cycle number or the calendar year when the definition takes place; default is 1. Once in effect, the changes stay until they are changed again.

Field 2: Fuel model index number from table 3.2. Values for the standard 13 fuel models of Anderson (1982) are 1 through 13. Number 14 is a modified version of fuel model 11. You can define new fuel models by giving them values greater than the maximum number listed in table 3.2, up to a maximum index value of 30.

Field 3: Surface to volume ratio (1/ft) for 0 to 0.25 inch fuel.

Field 4: Surface to volume ratio for 0.25 to 1 inch fuel.

Field 5: Surface to volume ratio for 1 to 3 inches fuel.

Field 6: Surface to volume ratio for live fuel.

Field 7: Loading for 0 to 0.25 inch fuel.

Field 8: Loading for 0.25 to 1 inch fuel.

Field 9: Loading for 1 to 3 inches fuel.

Table 3.2—Fire behavior fuel models used in the FFE-FVS. Values can be changed using the DEFULMOD keyword.

Name	DEFULMOD keyword field numbers										
	2	3	4	5	6	7	8	9	10	11	12
	Index Number	Surface to volume ratio (1/ft)				Loading (lb/ft ²)				Depth (ft)	Moisture of Extinction
	0-0.25"	0.25-1"	1-3"	Live	0-0.25"	0.25-1"	1-3"	Live			
Short grass	1	3500	109	30	1500	0.034	0	0	0	1	0.12
Timber (grass & understory)	2	3000				0.092	0.046	0.023	0.023	1	0.15
Tall grass	3	1500				0.138	0	0	0	2.5	0.25
Chaparral	4	2000				0.23	0.184	0.092	0.23	6	0.20
Brush	5	2000		0		0.046	0.023	0	0.092	2	0.20
Dormant brush, hardwood slash	6	1750			1550	0.069	0.115	0.092	0	2.5	0.25
Southern rough	7	1750			1550	0.052	0.086	0.069	0.017	2.5	0.40
Closed timber litter	8	2000	109	30	1500	0.069	0.046	0.115	0	0.2	0.3
Hardwood litter	9	2500				0.134	0.019	0.007	0	0.2	0.25
Timber (litter & understory)	10	2000				0.138	0.092	0.23	0.092	1	0.25
Light logging slash	11	1500				0.069	0.207	0.253	0	1	0.15
Medium logging slash	12	1500				0.184	0.644	0.759	0	2.3	0.2
Heavy logging slash	13	1500				0.322	1.058	1.288	0	3	0.25
Light-medium logging slash	14	1500				0.126	0.426	0.506	0	1.8	0.2

Field 10: Loading for Live fuel.

Field 11: Fuel depth (ft).

Field 12: Moisture of extinction.

FUELMODL Specify the fuel models and the weights used in place of the fuel model selection described in chapter 2, “Model Description.” This keyword overrides the dynamic and static fuel model selection during the years it is in effect. Code fields 8 and 9 on a second line, each value in fields that are 10 columns wide starting in column 1. If these fields are not used, there must be a blank line after the keyword. The weights are automatically scaled so that they sum to 1.

Field 1: The FVS cycle number or the calendar year the fuel models specified start being used; default is 1.

- Field 2: Index to fuel model 1 (if left blank or zero, then the automatic logic is used from this year onward).
- Field 3: Weight given fuel model 1; default is 1.
- Field 4: Index to fuel model 2.
- Field 5: Weight given fuel model 2; default is 1 when field 4 contains an entry, zero otherwise.
- Field 6: Index to fuel model 3.
- Field 7: Weight given fuel model 3; default is 1 when field 6 contains an entry, zero otherwise.
- Field 8: Index to fuel model 4.
- Field 9: Weight given fuel model 4; default is 1 when field 8 contains an entry, zero otherwise.

DROUGHT Set drought years for the fuel model selection process. Drought conditions are used in the automatic fuel model selection in a few variants.

- Field 1: The FVS cycle number or the calendar year when the drought starts; default is 1.
- Field 2: The duration in years; default is 1.

Figure 3.8 illustrates the used of **FUELMODL** and **DEFULMOD** keywords to simulate two fires – one in 2002 (lines FFE 2-4) and the other in 2037 (lines FFE 5-9). A line-by-line explanation follows:

- Line FFE 1: The **FMIN** keyword signals that FFE keywords follow.
- Line FFE 2: **SIMFIRE** is used to signal that a fire is simulated in 2002 using default moisture and weather conditions.
- Lines FFE 3 and 4: The **FUELMODL** keyword is used to specify that two fuel models will be used, model 8 receives 40 percent of the weight and model 10 receives 60 percent of the weight. Note that FFE scales the weights so that they sum to 1. Rather than percentages, 0.4 and 0.6 could have been used, or simply the numbers 4 and 6. Note that this keyword has nine fields and that the last two are coded on a separate line. This additional line must be entered even if the values are left blank.
- Line FFE 5: A second **SIMFIRE** is used to simulate another fire, this one in 2037.

Line Number	Column ruler											
	-----1-----2-----3-----4-----5-----6-----7-----8	Keyword	Field 1	Field 2	Field 3	Field 4	Field 5	Field 6	Field 7			
1-11	See figure 3.1											
FFE 1	Fmin											
FFE 2	SimFire		2002									
FFE 3	FuelModl		2002		8		40		10	60		
FFE 4												
FFE 5	SimFire		2037									
FFE 6	DeFulMod		2037		30		2000		109	30	1500	0.069
FFE 7	0.046		0.115		0		0.2		0.3			
FFE 8	Fuelmodl		2037		30		.4		10	.6		
FFE 9												
FFE 10	End											
12-17	See figure 3.1											

Figure 3.8—This keyword file shows a fire simulated in 2002 with a specific set of fire behavior fuel models and another fire, set in 2037 that uses specific fuel model parameters.

Lines FFE 6 and 7: In the year 2037 (see field 1) fuel model index 30 (see field 2) is defined with the values coded in the remainder of the fields.

Lines FFE 8-9: This new fuel model, number 30, is given weight 0.4 and used with the existing fuel model 10. Close inspection of the values used to define fuel model 30 happen to be exactly those tabulated for model 8. The practical consequence of this example is that the fire that burns in the year 2037 will have similar flame lengths as the one that burns in 2007. They will be exactly the same if the stand canopy closure is identical. Canopy closure affects midflame wind speed, and it in turn affects fire intensity.

Line FFE 10: The END keyword is used to signal that the keywords that follow are base FVS keywords.

If **POTFIRE** keyword were added to the example shown in figure 3.8, the values in the potential fire report would be affected by the **FUELMODL** values shown for year 2002 and 2037. Furthermore, if the **DEFULMOD** keyword were used to change the values of some or all of the default fuel models, the values in the Potential Fire report may also change. Lastly, if the **STATFUEL** keyword is entered, the static rather than dynamic fuel model logic would be used for simulated fires.

3.5 Adjusting Snag Parameters

3.5.1 Introduction

You can modify how FFE calculates the creation, decay, breakage, falling, and removal of snags using the keywords shown in table 3.3. Keywords that control height loss, decay, and falling of snags are presented in this section. Review section 2.3 of chapter 2, “Model Description,” for an overview of all aspects of how the FFE models snags. Note that the length of time it takes for a snag to lose, say, half of its height, or to fall down, depends on whether it is hard or soft. The proportion of snags that are soft, rather than hard, when they are created is controlled using the **SNAGPSFT** keyword presented in section 3.5.3 on snag decay.

3.5.2 Height Loss

Height loss occurs in two stages. The first stage lasts until 50 percent of the original height is lost. The second stage lasts for the remainder of the life of the snag. Use the **SNAGBRK** to change the number of years it takes for hard and soft snags of various species to lose 50 percent of the height they had at the time the tree died and to set the number of additional years it takes for the remaining 30 percent of the snag’s height to be lost. The FFE converts

Table 3.3—Summary of the keywords controlling snags.

Keyword	Use	Section
SALVAGE	Remove snags as a management action	3.7.2
SNAGBRK	Change the rate snag height declines	3.5.2, 3.5.3
SNAGDCAY	Change the snag decay rate	3.5.3
SNAGFALL	Change snag fall down rate	3.5.4
SNAGPBN	Change snag fall down rate	3.5.4
SNAGINIT	Set the initial number and size of snags	3.3
YARDLOSS	Creates snags as part of FVS management actions	3.7.1

these values into snag breakage rates and uses them in the snag breakage equations described in section 2.3 of chapter 2, “Model Description.” The snag breakage rates for initially soft snags are generally faster than initially hard snags.

SNAGBRK Control the snag height loss rates. The default values depend on the species of the snag. See the individual variant description for details.

Field 1: The tree species letter code or number for the FVS variant you are using. Code a zero (“0”) or “All” for all species; the default is 0.

Field 2: The number of years from when a *hard* snag is created until 50 percent of the original height is lost.

Field 3: The number of years from when a *soft* snag is created until 50 percent of the original height is lost.

Field 4: The number of years from when a *hard* snag is created until the next 30 percent of the original height is lost. The height loss rate implied by this number is used until the snag falls down.

Field 5: The number of years from when a *soft* snag is created until the next 30 percent of the original height is lost. The height loss rate implied by this number is used until the snag falls down.

3.5.3 Snag Decay

You can control the time it takes for a hard snag to become soft using the **SNAGDCAY** keyword to set a multiplier that is used to adjust the base rate. The formula used to compute the base rate is covered in section 2.3.5 of chapter 2, “Model Description.” It is a linear function of species and size (dbh). Inside the model, the only significant difference between a hard snag and one that has become soft is that fuel from soft snags decays differently than that from hard snags (but see section 3.5.2 for a difference for soft snags that were never hard).

Table 3.4 shows a set of multipliers that imply different numbers of years that snags of different sizes will take to make the transition from being hard to being soft. For example, a multiplier of 1 means that a 10-inch tree will take 27 years to become soft, while a 20-inch tree will take 39 years to become soft. You can use the multipliers shown in the body of the table to pick adjustment multipliers that meet your needs. Note that a single multiplier is used for all sizes of a given species.

You control the proportion of newly created snags that are classified as soft using the **SNAGPSFT** keyword.

SNAGDCAY Set a rate multiplier that modifies how fast hard snags become soft.

Field 1: The tree species letter code or number for the FVS variant you are using. Code a zero (“0”) or “All” for all species; the default is 0.

Table 3.4—Multipliers useful in the SNAGDCAY keyword that result in different numbers of years that must pass for a hard snag to become soft. Multipliers near 1.0 are shown in bold as a reference to show the implications of the default decay rates.

Years to soft	Snag dbh (inches)				
	10	15	20	25	30
10	0.38	0.31	0.26	0.22	0.20
20	0.76	0.62	0.52	0.45	0.39
30	1.14	0.93	0.78	0.67	0.59
40	1.53	1.23	1.04	0.89	0.78
50	1.91	1.54	1.29	1.12	0.98
60	2.29	1.85	1.55	1.34	1.18
70	2.67	2.16	1.81	1.56	1.37
80	3.05	2.47	2.07	1.78	1.57
90	3.43	2.78	2.33	2.01	1.76
100	3.81	3.08	2.59	2.23	1.96

Field 2: The rate of decay adjustment multiplier; must be positive; Higher values increase the amount of time it takes for a hard snag to become soft. Default is 1.0.

SNAGPSFT Set the proportion of snags listed *soft* when trees die. This proportion applies to snags created from all sources, which include those specified using the **SNAGINIT** keyword (section 3), the input sample tree data file, mortality caused by fires and all other causes, and by stand management. The snags that are initially soft can lose height at a different rate than those snags that are initially hard.

Field 1: The tree species letter code or number for the FVS variant you are using. Code a zero (“0”) or “All” for all species; the default is 0.

Field 2: The proportion of snags that are *soft* when they are created; range is 0 to 1; default is zero.

3.5.4 Snag Fall

The FFE computes that rate at which snags fall depending on whether the snag was present at the time of a fire in addition to the snag’s size and species. Furthermore, there is a built-in assumption that some of the large snags (a few of those over 18 inches dbh) will stand for a long time. See section 2.3.6 of chapter 2, “Model Description,” for all the details.

The **SNAGFALL** keyword is used to specify a species-specific multiplier of the base snag fall rate that is calculated by the FFE. Using this keyword, you can also specify how long some of the large snags stand.

The default values, those that are obtained by entering a multiplier of 1, are defined such that 95 percent of 10-inch snags will fall in 20 years, and they will all be gone in 22 years. For a 20-inch snag, 95 percent will fall in 31 years, and they will all fall in 100 years. Table 3.5 shows a set of multipliers that imply different numbers of years that snags of different sizes will take to fall. For example, to have 95 percent of 15-inch snags fall in 40 years, a multiplier

Table 3.5—Multipliers useful in the SNAGFALL keyword that result in different numbers of years that must pass before 95 percent of the snags fall. Multipliers near 1.0 are shown in bold as a reference to show the implications of the default fall rates.

Years to 95% Fall	Snag dbh (inches)				
	10	15	20	25	30
10	2.00	2.43	3.09	4.25	6.81
20	1.00	1.21	1.55	2.13	3.41
30	0.67	0.81	1.03	1.42	2.27
40	0.50	0.61	0.77	1.06	1.70
50	0.40	0.49	0.62	0.85	1.36
60	0.33	0.40	0.52	0.71	1.14
70	0.29	0.35	0.44	0.61	0.97
80	0.25	0.30	0.39	0.53	0.85
90	0.22	0.27	0.34	0.47	0.76
100	0.20	0.24	0.31	0.43	0.68
110	0.18	0.22	0.28	0.39	0.62
120	0.17	0.20	0.26	0.35	0.57
130	0.15	0.19	0.24	0.33	0.52
140	0.14	0.17	0.22	0.30	0.49
150	0.13	0.16	0.21	0.28	0.45

of 0.61 would be entered in Field 2 of the **SNAGFALL** keyword. Multipliers for snags of other sizes or persistence times can be estimated through interpolation. Note that the multiplier in field 2 of the keyword is used for all sizes of snags. For example, if a multiplier of 0.5 were to be used, 95 percent of 10-inch snags would fall in 40 years, while 30-inch snags would take 139 years for 95 percent of them to fall.

The **SNAGPBN** (**SNAG** Post **BurN**) keyword is used to set the snag fall down rates for snags that exist when a fire burns. The basic assumption is that soft snags and small snags fall faster than hard snags and large snags if they are present when a fire burns. Using the defaults for this keyword implies that all soft snags and 90 percent of snags less than 12 inches will fall in 7 years after any fire. Note that the parameters are not species specific and that the rates implied by the **SNAGFALL** keyword will take precedence if they are faster than the postfire rates.

SNAGFALL Set a rate multiplier that modifies how soon snags fall and set the length of time the some of the large snags stand.

Field 1: The tree species letter code or number for the FVS variant you are using. Code a zero (“0”) or “All” for all species; the default is 0.

Field 2: The rate of fall adjustment multiplier; must be greater than or equal to 0.001; default is 1.0. This affects all snags less than 18 inches dbh and the first 95 percent of snags greater than 18 inches. Values greater than 1.0 cause the snag to fall faster.

Field 3: The snag age (number of years the tree is dead) by which the last 5 percent of snags have fallen. This only affects snags larger than 18 inches dbh.

- SNAGPBN** Control the fall rates for snags that are present during a fire.
- Field 1: Proportion of soft snags that will fall faster after a fire; range is 0 to 1; default is 1.0.
 - Field 2: Proportion of small snags that will fall faster after a fire; range is 0 to 1; default is 0.9.
 - Field 3: Number of years it will take for these snags to all fall; default is 7.
 - Field 4: dbh (inches) that divides small snags from large snags for this calculation; default is 12.
 - Field 5: Scorch height (feet) that must be exceeded for the increased fall rates implied by this option to be used by the FFE; default is 0.

3.5.5 Summary

Snag height loss and fall down have a combined impact on the overall amount of volume represented by snags. The definition of one set of parameters may make it less important to define the other. For example, if multipliers are defined so that the snags all fall within 10 years, the impact of the height loss is negligible. And if the height loss rates are very high, it may be less important to precisely define the fall rate. Direct creation and removal of snags is done using keywords found elsewhere in the guide (table 3.3).

3.6 Adjusting Fuel Parameters

Fuels accumulate, they decompose, and if there is a fire, they burn. These processes are covered in detail in section 2.4 of chapter 2, “Model Description.” This section covers those keywords that affect fuel decomposition. Section 3.3 described how to set the initial amount of fuel using **FUELINIT** keyword. The breakage of snags is a source of fuel; keywords that control snags are presented in section 3.5. Management actions, like thinning, can add to fuel. Parameters that control how much fuel is added are set using the **YARDLOSS** keyword presented in section 3.7.1. Burning piled fuel as a treatment is simulated using the **PILEBURN** keyword described in section 3.4.3. Fuel consumption from prescribed or wildfire is simulated using the **SIMFIRE** keyword, described in section 3.4.2. The moisture of fuel influences consumption and can be modified using the **MOISTURE** keyword presented in section 3.4.2.

3.6.1 Decay Rates

Fuels are tracked in several pools. A pool is like a table entry where the rows are the six fuel size classes and the columns are four decay rate classes. That makes 24 fuel pools.

You can change the decay rates associated these pools using the **FUELDCAY** keyword. You can modify the decay rates for each rate class rather than setting them directly using the **FUELMULT** keyword to specify a multiplier of the model’s default rates.

FUELDCAY Set the decay rates for each the fuel pools. The default values depend on the variant.

- Field 1: Decay class code, range 1 through 4. Code a 5 to set the rates for all four decay classes at once; an entry is required.
- Field 2: Decay rate for the litter fuel size class.
- Field 3: Decay rate for the duff fuel size class.
- Field 4: Decay rate for the 0 to 0.25-inch fuel size class.
- Field 5: Decay rate for the 0.25 to 1-inch fuel size class.
- Field 6: Decay rate for the 1 to 3-inches fuel size class.
- Field 7: Decay rate for the greater than 3 inches fuel size class.

FUELMULT Specify multipliers for each decay rate class that applies to the decay rates for all fuel size classes.

- Field 1: Multiplier for decay rate class 1=very slow; default is 1.
- Field 2: Multiplier for decay rate class 2=slow; default is 1.
- Field 3: Multiplier for decay rate class 3=fast; default is 1.
- Field 4: Multiplier for decay rate class 4=very fast; default is 1.

3.6.2 Assignment to Pools

The decay rate class of fuel is determined by the tree species from which it originated. By default, in most variants, all of the biomass for all species is added to the first decay rate class (see section 2.4.5 of chapter 2, “Model Description”). You can change the assignment of a species to a different decay rate class (or pool) using the **FUELPOOL** keyword. If different decay rates are set for each decay class, then the assignment of the species to a class is important.

FUELPOOL Specify the assignment of each species to a specific decay rate class.

- Field 1: Valid species letter codes or number. Use a “0” or “ALL” to indicate all species; no default.
- Field 2: Decay rate class number, 1 to 4; no default.

As the biomass in each pool decays, some portion becomes duff, while the remainder is lost to the air. Because duff usually decays slowly, the amount of decayed biomass that becomes duff plays an important role in the amount of duff present in the stand over the long term. The decay rate of the duff pool can be changed using the **FUELDCAY** keyword described above. You can change the proportion of the decayed biomass that goes into the duff pool using the **DUFFPROD** keyword. This keyword does not affect the decay rate of the original pools, just the amount that moves from the original pools to the duff pool. The portion that does not enter the duff pool is lost to the atmosphere and is not tracked by the FFE.

DUFFPROD Set the proportion of the decayed material that becomes duff, the remainder is lost.

- Field 1: Decay class code, range 1 through 4. Code a 5 to set the proportion for all four classes at once; there is no default.
- Field 2: Proportion of decayed litter; default is 0.02.

- Field 3: Proportion for the 0 to 0.25 inch fuel; default is 0.02.
- Field 4: Proportion for the 0.25 to 1 inch fuel; default is 0.02.
- Field 5: Proportion for the 1 to 3 inches fuel; default is 0.02.
- Field 6: Proportion for the greater than 3 inches fuel; default is 0.02.
- Field 7: Proportion for all fuel size classes. Values coded in this field automatically replace blanks in fields 2 to 6; default is 0.02.

Figure 3.9 illustrates some of the keywords presented this section. The example assumes that fuel originating from all species is placed by default in the first decay rate pool. In line FFE 2 of figure 3.9, the **FUELMULT** keyword is used to modify the second decay rate class so that the rates are twice as fast as those in the first pool and to modify rates in the third class so that they are half as fast. In line FFE 3, the **FUELPOOL** keyword is used to assign aspen (using species code AS) to the second class and, in line FFE 4, cedar (using species code WC) is assigned to the third. Line FFE 5 is shown as a reminder that if you don't ask for output, none is provided. In this case, the **FUELOUT** keyword (described in section 3.8) is used to request that fuel reports start in year 2000.

3.7 Management

Various management options exist in both the FFE and the base FVS model. Most of these options have a direct impact on snags or fuels by creating or destroying them (table 3.6). These options will also have an indirect impact on fuels or fire intensity. For example, removing snags through salvage logging will directly decrease the number of snags. It will indirectly decrease the amount of fuel because there will be less input coming from the snags. It could also indirectly affect the fire intensity or smoke emissions because these can be dependent on fuel loads. Only one option has an impact on fuel depth, and thus directly on fire intensity.

All the management options with the exception of pile burning (section 3.4.3) are discussed in the remainder of this chapter. Two base model keywords are discussed in this document because of their direct impact on FFE snags and fuels.

Line Number	Column ruler						
	1	2	3	4	5	6	7
1-11	See figure 3.1						
FFE 1	Fmin						
FFE 2	FuelMult	1	2	.5			
FFE 3	FuelPool	AS	2				
FFE 4	FuelPool	WC	3				
FFE 5	FuelOut	2000					
FFE 6	End						
12-17	See figure 3.1						

Figure 3.9—The fuel decay rate for the second decay rate class is modified to be twice as fast and the rate for the third class half as fast as the default rates. Then biomass from aspen (species code AS) trees is assigned to the second class and from cedar (species code WC) is assigned the third.

Table 3.6—Summary of management action keywords that affect snags, fuel, and fuel depth.

Keyword	Use	Model	Section
FUELMOVE	Change the distribution of fuel among fuel size classes	FFE	3.7.4
PILEBURN	Decrease the amount of fuel	FFE	3.4.3
FUELRET	Change the fuel depth and therefore its bulk density	FFE	3.7.4
PRUNE	Increase the amount of fuel and the base crown height	Base	3.7.2
SALVAGE	Decrease the number of snags	FFE	3.7.3
YARDLOSS	Increase the number of snags and increase or decrease the amount of biomass left after a logging operation.	Base	3.7.2

3.7.1 Base Model Keywords

When management options such as thinning are done in the main FVS model, the FFE assumes that the crowns from the cut trees are left in the stand on the ground and the stems are removed. A base model keyword, **YARDLOSS**, allows you to change these assumptions and to make some others. The keyword can be used to create snags by “cutting” trees and leaving them dead and standing in the stand. Alternatively, some of the trees can be left in the stand on the ground. These two options are especially useful when simulating a thinning in which some trees are left in the stand. The keyword only applies to the thinning actions that immediately follow it in the keyword file and are scheduled for the same year. You can use the **YARDLOSS** keyword as often as necessary to achieve your needs. Whole tree yarding can be represented using this keyword.

YARDLOSS Set the proportion of the harvested stems that are not removed and, of those, set the portion that is left standing. Also specify the proportion crown biomass that is removed with removed stems.

Field 1: The FVS cycle number or the calendar year; default is 1.

Field 2: Proportion of harvested stems that are not removed from stand; default is 0. Setting this to 1.0 simulates “cut and leave”.

Field 3: Proportion of the trees that are left in the stand that are down; default is 1.0. Biomass from trees that are left in the stand and are down is added to the fuel pools and trees that are not down become snags. Biomass from snags is added to fuel pools as the snags fall apart and fall down, just as when they are created through mortality.

Field 4: Proportion of crowns remaining in stand from removed stems; default is 1. Set this value to 0.0 to simulate whole tree removal.

Figure 3.10 illustrates how to use the **YARDLOSS** keyword. In this example, a stand is being thinned from below to remove a large number of the small trees. At the same time, some large trees are killed but are all left in the stand as snags. Line 12 signals that, for the next thinning option, all of

Line Number	Column ruler							
	1	2	3	4	5	6	7	8
	Keyword	Field 1	Field 2	Field 3	Field 4	Field 5	Field 6	Field 7
1-11	See figure 3.1							
12	YardLoss	2000	1	1	1			
13	ThinBBA	2000	0	1	5			
14	YardLoss	2000	1	0	0			
15	ThinABA	2000	200	.1	20	999		
FFE 1	Fmin							
FFE 2	FuelOut	2000						
FFE 3	End							
	See lines 12-17 in figure 3.1							

Figure 3.10—The use of the FVS keyword YardLoss is shown in conjunction with two thinning options. Had the YardLoss keywords been left out, the FFE would not account for the stem wood left in the stand from the precommercial thinning (line 13) nor would account for the standing snags created in the thinning from above (line 15).

the trees will be left in the stand, and that 100 percent of those that are left will be left down. As none of the trees will be removed, the value coded in the fourth field is ignored. Line 13 shows the **ThinBBA** keyword used to cut all of the trees less than 5 inches dbh with 100 percent efficiency. Line 14 shows that the **YARDLOSS** keyword is used a second time to specify that all the trees are not removed and are not felled. Therefore, all the trees in the following harvest will become snags. Line 15 illustrates the **ThinABA** keyword used to “cut” trees larger than 20 inches dbh, down to a residual of 200 ft² of basal area, with a 10 percent efficiency. Lines FFE 1 to 3 illustrate a request for the fuel model output.

The second base model keyword, **PRUNE**, is used to shorten crowns. Biomass from pruned branches is added to the appropriate fuel pools. The indirect impact within the FFE is that pruning can change the crown base height, weight, and density, thus affecting the chance of a crown fire occurring. The options for this keyword are discussed more fully in other documents.

3.7.2 Snag Management

Use the **SALVAGE** keyword to simulate the removal of snags. You can specify a size range, age, and decay status of snags to be removed.

SALVAGE Schedule a snag removal operation.

Field 1: The FVS cycle number or the calendar year; default is 1.

Field 2: Minimum dbh (inches) to be removed; default is 10.

Field 3: Maximum dbh (inches) to be removed; default is 999.

Field 4: Maximum number of years the removed snags have been dead; default is 5.

Field 5: Decay state to remove where: 0=both hard and soft, 1=hard, and 2=soft snags; default is 1.

Field 6: Proportion of eligible snags to remove; default is 0.9.

Field 7: Proportion of affected snags to leave in the stand; default is 0.0.

A chaining operation can be simulated using the **SALVAGE** keyword in conjunction with base FVS keywords (fig. 3.11). To achieve the effect of chaining, the **YARDLOSS** and **THINBBA** keywords (lines 12 and 13) are used to fell all the trees, leaving them in the stand. Secondly, the **SALVAGE** keyword (line FFE 2) is used to fell all the snags, leaving them all in the stand. As in previous examples, a fuels output report is requested on line FFE 3.

3.7.3 Fuel Management

You can manage fuels by changing fuel depth and by changing the amount of fuel in each size class. The **PILEBURN** keyword, covered in section 3.4.3, changes the amount of fuel. In this section, keywords used to change the depth or amount of fuel are presented.

The practical methods of changing fuel depth include direct fuel treatments, such as lopping or trampling, or harvest methods that result in different amounts or distributions of fuels. These might include ground-based skidding verses skyline or helicopter logging. You can change the size-class distribution of fuels by chipping or chunking large fuels so that they become small. Or you can simply haul fuels away.

Use the **FUELTRET** keyword to modify the fuel depth and use the **FUELMOVE** keyword to transfer fuels from one size class to another. The **FUELTRET** keyword allows you to specify the name of a fuel treatment or logging method; for each method the FFE supplies a multiplier (table 3.7) to the fuel depth that simulates the treatment. If you prefer, you can specify the multiplier yourself and ascribe any meaning you wish to its use.

Line Number	Column ruler						
	1	2	3	4	5	6	7
	Keyword	Field 1	Field 2	Field 3	Field 4	Field 5	Field 6
1-11	See figure 3.1						
12	YardLoss	2010	1	1	1		
13	ThinBBA	2010	0				
FFE 1	Fmin						
FFE 2	Salvage	2010	0	999	999	1	1
FFE 3	FuelOut	2000					
FFE 4	End						
	See lines 12-17 in figure 3.1						

Figure 3.11—Chaining is simulated by cutting all trees (line 13), leaving them in the stand (line 12), and cutting all snags and leaving them in the stand as well (line FFE 2).

Table 3.7—Default fuel depth multipliers used to simulate various nominal fuel treatments and harvest types. Specifying the multiplier on field 4 of the **FUELTRET** keyword has the same effect in the FFE as specifying the nominal treatment.

Harvest Method (field 3)	Fuel Treatment (field 2)		
	0=none	1=lopping or flailing	2=trampling, chopping, chipping, or crushing
1=ground-based, cat skidding or line skidding	1.0	0.83	0.75
2=high lead or skyline,	1.3	0.83	0.75
3=precommercial or helicopter	1.6	0.83	0.75

The **FUELMOVE** keyword does not image any nominal treatments. You specify an amount of fuel to move from one class to another. You may alternatively specify the proportion to move or the residual to leave. You ascribe the practical meaning to the use of this keyword.

FUELRET Specify a fuel treatment or harvest method, or specify the multiplier used to modify the fuel depth.

Field 1: The FVS cycle number or the calendar year; default is 1.

Field 2: Fuel treatment type: 0=none, 1=lopping or flailing, 2=trampling, chopping, chipping, or crushing; default is 0.

Field 3: Harvest type: 1=ground-based, cat skidding or line skidding, 2=high lead or skyline, 3=precommercial or helicopter; default is 1.

Field 4: Multiplier used to increase or decrease fuel depth; default depends on the values in field 2 and 3 (table 3.7) but if both are 0.0, the default for this field is 1.0.

Figure 3.12 shows how to specify two fuel treatments. Line FFE 2 illustrates that a lopping treatment is applied in 2010, thereby reducing the fuel depth to 83 percent of its depth prior to the treatment. Line FFE 3 shows another treatment that increases the fuel depth by 10 percent in 2030.

FUELMOVE Move fuel between size classes to simulate fuel treatments. The amount of fuel to move can be specified in five ways (see fields 3 through 7); if values are provided for more than one method, the FFE will use the method that results in the largest transfer. Setting the source pool to 0=none implies that fuel is being imported from outside and setting the destination pool to 0=none implies that fuel is being removed. The order that **FUELMOVE** keywords are entered into the keyword file is important, especially if proportions are used. FFE processes keywords in the scheduled order and removes the fuel from the source pool at that time. The fuel is not added to the destination pool until all keywords for the year have been processed.

Field 1: The FVS cycle number or the calendar year; default is 1.

Line Number	Column ruler						
	1	2	3	4	5	6	7
1-11	See figure 3.1						
FFE 1	Fmin						
FFE 2	FuelTret	2010	1				
FFE 3	FuelTret	2030		1.1			
FFE 4	FuelOut	2000					
FFE 5	End						
	See lines 12-17 in figure 3.1						

Figure 3.12—This keyword file illustrates simulating fuel treatments, once with a nominal treatment that implies a fuel depth multiplier (0.83 in this case, see table 3.7) and a second that shows how to set a specific multiplier.

- Field 2: Source fuel pool (0=none, 1=less than 0.25 inch, 2=0.25 to 1 inch, 3=1 to 3 inches, 4=3 to 6 inches, 5=6 to 12 inches, 6=greater than 12 inches, 7=litter, 8=duff); default is 6.
- Field 3: Destination fuel pool; same codes used in field 2; default is 8.
- Field 4: Amount of fuel (tons per acre) to move from the source pool; default is 0.
- Field 5: Proportion of source fuel to move; default is 0.
- Field 6: Residual fuel (tons per acre) to leave in the source pool; default is 999.
- Field 7: Final amount (tons per acre) of fuel in the target; default is 0.

Figure 3.13 shows how to simulate a fuel treatment that chops large fuel into smaller pieces, presumably to increase decay rates and reduce future fire intensity. The treatment goal is to process 80 percent of the largest fuel (greater than 12 inches) such that 60 percent of the treated large fuel is added to the 1 to 3 inches class and the rest are added to the 0.25 to 1 inch class. The 6 to 12 inches fuel is similarly treated. Only a small amount of the 3 to 6 inches fuel is treated, to reduce the amount in that size class to about 12 tons per acre. A line-by-line description of the lines FFE 2-7, figure 3.13, follows with notes on the reasoning behind their use. Note that the order of the keywords is important.

Line FFE 2: 60 percent of the fuel in size class 6 is moved to size class 3. The FFE will remove these fuels from the size class before processing the next keyword, leaving the remaining 40 percent of the fuel in the size class.

Line FFE 3: 50 percent of the fuel remaining in size class 6 is moved to size class 2. Thus, in total, 80 percent of the fuel in size class 6 is moved.

Lines FFE 4 and 5: Fuel in size class 5 is moved using the same logic used to move fuel from size class 6 except that an amount of fuel is entered into field 4 of line FFE 5. The FFE calculates whether the 8 tons per acre amount specified in field 4 is more or less than 50 percent of the remaining fuel in the class. The greater of the two amounts is moved.

Lines FFE 6 and 7: Enough fuel is moved from size class 4 to size class 3 to bring the residual down to 18 tons per acre. Then, enough is moved from class 4 to 2 so that the residual is 12 tons per acre.

Line Number	Column ruler							
	-----1-----	-----2-----	-----3-----	-----4-----	-----5-----	-----6-----	-----7-----	-----8
	Keyword	Field 1	Field 2	Field 3	Field 4	Field 5	Field 6	Field 7
1-11	See figure 3.1							
FFE 1	Fmin							
FFE 2	FuelMove	2023	6	3		.6		
FFE 3	FuelMove	2023	6	2		.5		
FFE 4	FuelMove	2023	5	3		.6		
FFE 5	FuelMove	2023	5	2	8	.5		
FFE 6	FuelMove	2023	4	3			18	
FFE 7	FuelMove	2023	4	2			12	
FFE 8	FuelOut	2000						
FFE 9	End							
	See lines 12-17 in figure 3.1							

Figure 3.13—This keyword file illustrates the use of the FUELMOVE keyword to simulate breaking large fuel into smaller pieces (making chunks or chips).

Figure 3.14 shows how to use **FUELMOVE** to remove fuel from a stand. When removing fuel, the destination tagged as “0” in field 3, and when adding fuel, the source field is tagged as a “0” in field 2. The command is ignored if both the destination and the source fields are “0”. In the example, 85 percent of the 6 to 12 inches fuel and 90 percent of fuel over 12 inches is removed, and the rest is left in the stand. Note that the values are entered as proportions, not as percentages.

3.8 Output Keywords

The content of the output reports is presented in chapter 2, “Model Description,” along with the descriptions of the model components to which they apply. The keywords that control output generation are presented below. Seven output tables are available from the FFE. Four provide information about the current state of the stand in terms of levels of snags and fuel, or the potential fire intensity and effects. The remaining three are produced only after a fire and give summary information about the fire and the impact of the fire. Four of the output files have a second keyword that can be used to affect what is printed in the output file. For example, mortality and snags are printed as size class summaries, and keywords affect the definition of the size classes. Table 3.8 provides a list of the keywords that control or

Line Number	Column ruler							
	1	2	3	4	5	6	7	8
	Keyword	Field 1	Field 2	Field 3	Field 4	Field 5	Field 6	Field 7
1-11	See figure 3.1							
FFE 1	Fmin							
FFE 2	FuelMove	2023	5	0		.85		
FFE 3	FuelMove	2023	6	0		.90		
FFE 8	FuelOut	2000						
FFE 9	End							
	See lines 12-17 in figure 3.1							

Figure 3.14—This keyword file illustrates the use of the FUELMOVE keyword to simulate the removal of large fuel from the stand.

Table 3.8—List of output tables, the keywords that control them, and references to detailed output descriptions. Details on the keywords are presented in section 3.8 in the order they are presented below.

Report name	Keyword		Model Description section where the report is described
	Name	Use	
Potential fire report	POTFIRE	Request report	2.5.7
Detailed fuel report	FUELOUT	Request report	2.4.10
Burn conditions report	BURNREPT	Request report	2.5.7
Fuel consumption report	FUELREPT	Request report	2.5.7
Detailed mortality report	MORTREPT	Request report	2.5.7
Snag summary table	MORTCLAS	Modify diameter class boundaries	See this user's guide 2.3.8
	SNAGSUM	Request table	
Detailed snag report	SNAGCLAS	Modify diameter class boundaries; values also apply to the detailed snag report.	See this user's guide 2.3.8
	SNAGOUT	Request report	

affect output format and includes a reference to the location in chapter 2, “Model Description,” where the output is described.

All of the output tables except one are printed to the end of the main FVS output file. Because of its potential size, the detailed snag output table is printed to a separate file.

- POTFIRE** Request the potential fire report.
- Field 1: The FVS cycle number or the calendar year when the output starts; default is 1.
- Field 2: Number of years to output; default is 200.
- Field 3: Interval to output; default is 1 (every year).
- FUELOUT** Request the detailed fuels report.
- Field 1: The FVS cycle number or the calendar year when the output starts; default is 1.
- Field 2: Number of years to output; default is 200.
- Field 3: Interval to output; default is 1 (every year).
- BURNREPT** Request the burn conditions report output.
- Field 1: The FVS cycle number or the calendar year when the output starts; default is 1.
- Field 2: Number of years to output; default is 200.
- FUELREPT** Request the fuel consumption report.
- Field 1: The FVS cycle number or the calendar year when the output starts; default is 1.
- Field 2: Number of years to output; default is 200.
- MORTREPT** Request the detailed mortality report.
- Field 1: The FVS cycle number or the calendar year when the output starts; default is 1.
- Field 2: Number of years to output; default is 200.
- MORTCLAS** Specify the class boundaries used in the detailed mortality report. The classes must be specified in increasing order.
- Field 1: Minimum dbh of size class 1; default is 0 inches.
- Field 2: Minimum dbh of size class 2; default is 5 inches.
- Field 3: Minimum dbh of size class 3; default is 10 inches.
- Field 4: Minimum dbh of size class 4; default is 20 inches.
- Field 5: Minimum dbh of size class 5; default is 30 inches.
- Field 6: Minimum dbh of size class 6; default is 40 inches.
- Field 7: Minimum dbh of size class 7; default is 50 inches.
- SNAGSUM** Request the snag summary report. Unlike the other reports, you cannot control when this report output starts and ends.
- Field 1: If a negative number is entered, no report is generated (useful only to turn off a previously requested report).
- SNAGCLAS** Set the snag class boundaries used to assign snags to class in the snag summary report and for the detailed snag report. Values must be specified in increasing order.
- Field 1: Lower boundary of size class 1; default is 0 inches.

- Field 2: Lower boundary of size class 2; default is 12 inches.
- Field 3: Lower boundary of size class 3; default is 18 inches.
- Field 4: Lower boundary of size class 4; default is 24 inches.
- Field 5: Lower boundary of size class 5; default is 30 inches.
- Field 6: Lower boundary of size class 6; default is 36 inches.

SNAGOUT Request the detailed snag report.

- Field 1: The FVS cycle number or the calendar year when the output starts; default is 1.
- Field 2: Number of years to output; default is 200.
- Field 3: Interval to output; default is 5 years.
- Field 4: Fortran data set reference number to which the output file is written; default is 3.
- Field 5: Enter a 0 if you want headings output for this table, and enter a 1 if you want headings suppressed; default is zero.

SVIMAGES Set the number of frames, or images, showing the fire progression when the base model SVS keyword is used. This keyword is related to the use of the Stand Visualization System described the “Preface” and illustrated on cover of the volume.

Field 1: The number if frames or images; default is 3.

Figure 3.15 illustrates asking for every kind of output in addition to changing the default diameter class boundaries for the mortality report so that they exactly match the default boundaries for the snag report. The example starts with the keywords illustrated in figure 3.7. In that example, no reports were requested, yet the example included a pile burn and a simulated fire. Without those reports, evidence of the fires is limited to how the fire affects base FVS outputs.

Line FFE 5: Request the potential fire report be generated starting in the year 2000. The default interval of 1 year is used and the report is generated for 200 years.

Line Number	Column ruler								
	-----1-----2-----3-----4-----5-----6-----7-----8	Keyword	Field 1	Field 2	Field 3	Field 4	Field 5	Field 6	Field 7
1-11	See figure 3.1								
FFE 1	Fmin								
FFE 2	PileBurn	2007		100	15	75	1		
FFE 3	SimFire	2037	0	4					
FFE 4	FlameAdj	2037	0	0					
FFE 5	PotFire	2000							
FFE 6	FuelOut	2000							
FFE 7	BurnRept	2000							
FFE 8	FuelRept	2000							
FFE 9	MortRept	2000							
FFE 10	MortClas	0	12	18	24	30	36	9999	
FFE 11	SnagSum								
FFE 12	SnagOut	2000							
FFE 13	End								
12-17	See figure 3.1								

Figure 3.15—The keyword file from figure 3.7 with keywords added to ensure that all possible output files will be present.

Lines FFE 6 through 9: Request the detailed fuels, burn conditions, fuel consumption, and detailed mortality reports.

Line FFE 10: Set the class boundaries for the detailed mortality reports to those used in the snag reports. The last field is coded with an 9999 to specify a huge lower bound for the last class, so that there are really only six size classes for reporting, which means that all trees over 36 inches are reported in the sixth class.

Line FFE 11: Request the snag summary.

Line FFE 12: Request the detailed snag data be output to the data file reference by the number 3, every 5 years, for 200 years, as the defaults signify. The data file associated with the number 3 is automatically opened by FVS for the tree list output. This example does not use that feature of FVS so this file will contain only the snag data. If the tree list option were also used, the file would contain both the tree list and snag data.

3.9 Using the FVS Event Monitor

The Event Monitor (Crookston 1990) is part of the FVS system. The FFE interacts with the Event Monitor providing the ability to build powerful keyword command files. Using the capabilities of the Event Monitor you can specify logical expressions that are predicated on the value of state variables that are automatically updated by FVS. Activities, such as thinnings, can be set up so they are scheduled only if the logical expressions are true. You can define new state variables as functions of those that are predefined plus new ones that you defined earlier in the keyword set. You can also use variables to define the parameter fields on keywords rather than specifying constant values as shown in all the previous examples.

In this section, we build on the information provided by Crookston (1990) on how to use the Event Monitor with the base FVS system. Therefore, the following text assumes that you understand the information presented in that document.

The FFE capitalizes on the Event Monitor by supporting the use of its features. All FFE keywords that can be scheduled with a fixed year or cycle in field 1 can alternatively be scheduled as part of an IF-THEN sequence. All of these same keywords support the PARMs feature of the Event Monitor. Lastly, automatic variables have been created whose values are defined when the FFE is used. Note that the Event Monitor handles variables listed as having arguments as if they were functions. The variables are as follows.

FIRE has the value 1 (yes) if a fire was simulated in the preceding FVS cycle and has the value 0 (no) if not.

FIREYEAR is the year that the last fire is simulated; the value will be zero if a fire has not been simulated during the run.

MINSOIL is the percent of mineral soil exposure from the most recent fire.

FUELLOAD(arg1, arg2) is the total tons per acre of fuel in the stand for a range of fuel size classes. The lower limit of the range is defined using arg1, and the upper limit is arg2. The value of arg1 and arg2 can be the same. A coding system is used to specify the classes, where 1 is greater than 0 to less than 0.25 inch, 2 is equal or greater than 0.25 to less than 1 inch, 3 is equal or greater than 1 to less than 3 inches, 4 is equal or greater than 3 to less than 6 inches, 5 is equal or greater than 6 to less

than 12 inches, 6 is equal or greater than 12 inches, 7=litter, and 8=duff.

CROWNIDX is the crowning index reported in the potential fire report.

CRBASEHT is the crown base height reported in the potential fire report.

CRBULKDN is the crown bulk density reported in the potential fire report.

POTFLEN(arg1) is the flame length reported in the potential fire report for the severe fire conditions when arg1 is 1 and for the moderate fire conditions when arg1 is 2.

SNAGS(arg1, arg2, ..., arg7) is the total number, volume, or basal area of snags meeting the criteria specified using the arguments. Only the first three arguments are required, so only code the others if you need them. Note that the snag data are stored in 2 inch-wide dbh classes. The definitions of the arguments are:

Arg1 defines the type of information returned where 1= snag density, 2 = basal area, and 3 = volume.

Arg2 defines the tree species where 0 = all species and other values are the corresponding species codes for the variant. The numbers or the short alpha codes may be used.

Arg3 defines the decay status where 0 = all, 1 = hard, and 2 = soft.

Arg4 is the lower limit dbh in inches (greater or equal); the default is zero.

Arg5 is the upper limit dbh in inches (less than); the default is a large number.

Arg6 is the lower limit height in feet (greater or equal); the default is zero.

Arg7 is the upper limit height in feet (less than); the default is a large number.

TORCHIDX is the torching index reported in the potential fire report.

Figure 3.16 illustrates a simple example for scheduling pile burn whenever the small (litter and less than 3 inches) fuel loads are greater than 8 tons per acre. The COARSEWD function is used twice, once to sum up the first three fuel classes, and once to return the litter, as described in the following line-by-line account:

Line Number	Column ruler							
	-----1-----	-----2-----	-----3-----	-----4-----	-----5-----	-----6-----	-----7-----	-----8
	Keyword	Field 1	Field 2	Field 3	Field 4	Field 5	Field 6	Field 7
1-11	See figure 3.1							
12	If	10						
13	FuelLoad(1,3)+FuelLoad(7,7)				GT	8		
14	Then							
FFE 1	Fmin							
FFE 2	PileBurn	0						
FFE 3	End							
15	EndIF							
	See figure 3.1							

Figure 3.16—This keyword file shows how to use the FVS Event Monitor to schedule a pile burn any time small (litter and less than 3 inches) fuel loads are over 8 tons per acre.

Line 12: An FVS **IF** keyword is used to signal that a logical expression is being entered. The value of 10 in field 1 is a minimum waiting time between events. In this case, the pile burn can not be scheduled any more often than once each 10 years.

Line 13: The **FUELLOAD** function is used first to sum the first three fuel classes and secondly to get the litter. The sum of these two values is compared to 8.

Line 14: The **THEN** keyword signals that the expression has ended and that *activity keywords* follow. Activities are keywords that have a cycle number or year in the first field. They are scheduled when the event occurs, which is when the expression is true. When used in an IF-THEN sequence, the value coded in field 1 of activity keywords is added to the year the event occurs, and the sum is the year in which the activity is scheduled. Note that logical expressions that define events are only tested on FVS cycle boundaries; see the Event Monitor user's guide for more information (Crookston 1990).

Line FFE 1: The **FMIN** keyword signals that the FFE keywords follow.

Line FFE 2: All the fields on the **PILEBURN** are left to their defaults except field 1. The first field is set to 0 so the year the pile burn is scheduled is the same year as the event occurs. Recall that the default value for field 1 is 1. If that number had been used, the **PILEBURN** would be scheduled for the year following the year the event occurred.

Line FFE 3: End the FFE keywords.

Line 15: End the IF-THEN sequence.

The remainder of the file functions as shown in figure 3.3.

Figure 3.17 illustrates how to use the **PARMS** feature of the Event Monitor with the FFE keywords. In this example, the **FLAMEADJ** keyword is used to increase the computed flame length by an amount that is a function of the slope and aspect of the stand. No adjustment is made for flat ground, or slopes that face east or west. The flame length is increased by up to 50 percent on south facing slopes and decreased by the same amount on north facing slopes. The amount of the adjustment is computed using a cosine function. The line-by-line description of the keyword file follows:

Line FFE 1: Start the FFE keywords

Line FFE 2: Schedule a fire to burn in the year 2037.

Line FFE 3: Use the **PARMS** feature of the Event Monitor to compute the flame length multiplier. The Event Monitor's *cos* (cosine) function takes its argument in radians, so the aspect is multiplied by $\pi/180 \approx 0.01745$. The

Line Number	Column ruler							
	-----1-----	-----2-----	-----3-----	-----4-----	-----5-----	-----6-----	-----7-----8	
	Keyword	Field 1	Field 2	Field 3	Field 4	Field 5	Field 6	Field 7
1-11	See figure 3.1							
FFE 1	Fmin							
FFE 2	SimFire	2037						
FFE 3	FlameAdj	2037	Parms	(1-(.5*Slope*Cos(Aspect*0.01745)),	-1,	-1)		
FFE 3	End							
15	EndIF							
	See figure 3.1							

Figure 3.17—The FlameAdj keyword is used with the **PARMS** feature of the Event Monitor to dynamically compute a flame length adjustment. This example is not an endorsement of the formula.

cosine of aspect is multiplied by the slope so that places with little slope will have a small adjustment, regardless of aspect, and further multiplied by 0.5. The product is subtracted from 1 resulting in a multiplier of 0.5 for north aspects and 1.5 for south aspects that have 100 percent slopes. As the slope decreases to flat, the multiplier becomes close to 1.0; the same happens when aspect is more east or west. The example is used to illustrate how to use the PARMs feature and is not an endorsement of the formula. Note that the other two parameters of this keyword must be supplied. In this case, -1 is used to signal that the default values for those fields are used, which means that the model is to compute the flame length and crowning percentages.

Duncan C. Lutes
Donald C.E. Robinson



Chapter 4

Variant Descriptions

Abstract—The Fire and Fuels Extension (FFE) to the Forest Vegetation Simulator (FVS) simulates fuel dynamics and potential fire behavior over time, in the context of stand development and management. This report documents differences between geographic variants of the FFE. It is a companion document to the FFE “Model Description” and “User’s Guide.” People who use FFE variants can use this document to learn about the unique features of each geographic variant.

Keywords: FVS, FFE, forest fire, stand dynamics, snags, down woody debris

4.1 Introduction

The Fire and Fuels Extension (FFE) has been developed for a number of Forest Vegetation Simulator (FVS) variants: Northern Idaho, Central Rockies, Utah, Eastern Montana, Western Sierra, Blue Mountains, Eastern Cascades, Central Idaho, Tetons and Southern Oregon/Northern California. Northern Idaho was the first variant developed and is considered the “base variant” as described in the FFE Model Description and User’s Guide. The “Model Description” chapter provides an in-depth look into the logic and parameters of that variant. As new variants have been developed, logic and parameter modifications were made to the NI variant in order to model fire effects in the regions covered by the new variants. The modifications were based on workshops and consultations with scientists and other fire experts familiar with each variant’s region. Many revisions were based on “expert knowledge” and unpublished information. References are included for modifications based on published information.

The user can modify many of the model processes, for instance snag dynamics. Some of the keywords are identified in this document; however, all of the user keywords are described in the “Model Description” chapter.

The purpose of this document is to describe the parameterization differences and, where applicable, logical modifications made to the NI variant in order to make the FFE model fire effects appropriately in new variants of the Fire and Fuels Extension to FVS.

4.2 Northern Idaho (NI)

4.2.1 Tree Species

The Northern Idaho variant models the 10 tree species shown in table 4.1. One additional category, “other” is modeled using western hemlock.

4.2.2 Snags

The majority of the snag model logic is based on unpublished data provided by Bruce Marcot (USFS, Portland, OR, unpublished data 1995). Snag fall parameters were developed at the FFE design workshop. A complete description of the Snag Submodel is provided in section 2.3 of the FFE “Model Description” chapter.

Four variables are used to modify the Snag Submodel for the different species in the NI-FFE variant:

- A multiplier to modify the species’ fall rate
- A multiplier to modify the time required for snags to decay from a “hard” to “soft” state
- The maximum number of years that snags will remain standing
- A multiplier to modify the species’ height loss rate

These variables are summarized in tables 4.2 and 4.3.

Snag bole volume is determined in using the base FVS model equations. The coefficients shown in table 4.4 are used to convert volume to biomass. Soft snags have 80 percent the density of hard snags.

Snag dynamics can be modified by the user using the **SNAGBRK**, **SNAGFALL**, **SNAGDCAY**, and **SNAGPBN** keywords described in the FFE “Model Description” chapter.

4.2.3 Fuels

Information on live fuels was developed using FOFEM 4.0 (Reinhardt and others 1997) and FOFEM 5.0 (Reinhardt and others 2001) and in cooperation with Jim Brown (USFS, Missoula, MT pers. comm. 1995). A complete description of the Fuel Submodel is provided in section 2.4 of the FFE “Model Description” chapter.

Table 4.1—Tree species simulated by the Northern Idaho variant.

Common name	Scientific name	Notes
western white pine	<i>Pinus monticola</i>	
western larch	<i>Larix occidentalis</i>	
Douglas-fir	<i>Pseudotsuga menziesii</i>	
grand fir	<i>Abies grandis</i>	
western hemlock	<i>Tsuga heterophylla</i>	
western redcedar	<i>Thuja plicata</i>	
lodgepole pine	<i>Pinus contorta</i>	
Engelmann spruce	<i>Picea engelmannii</i>	
subalpine fir	<i>Abies lasiocarpa</i>	
ponderosa pine	<i>Pinus ponderosa</i>	
other		= mountain hemlock

Table 4.2—Default snag fall, snag height loss and soft-snag characteristics for 20 inch DBH snags in the NI-FFE variant. These characteristics are derived directly from the parameter values shown in table 4.3.

Species	95% fallen	All down	50% height	Hard-to-soft
-----Years-----				
western white pine	34	110	33	42
western larch	34	110	33	42
Douglas-fir	34	110	33	42
grand fir	28	90	27	35
western hemlock	28	90	27	35
western redcedar	28	90	27	35
lodgepole pine	28	90	27	35
Engelmann spruce	28	90	27	35
subalpine fir	28	90	27	35
ponderosa pine	31	100	30	39
other	31	100	30	39

Table 4.3—Default snag fall, snag height loss and soft-snag multipliers for the NI-FFE. These parameters result in the values shown in table 4.2. (These three columns are the default values used by the SNAGFALL, SNAGBRK, and SNAGDCAY keywords, respectively.)

Species	Snag fall	Height loss	Hard-to-soft
western white pine	0.9	0.9	1.1
western larch	0.9	0.9	1.1
Douglas-fir	0.9	0.9	1.1
grand fir	1.1	1.1	0.9
western hemlock	1.1	1.1	0.9
western redcedar	1.1	1.1	0.9
lodgepole pine	1.1	1.1	0.9
Engelmann spruce	1.1	1.1	0.9
subalpine fir	1.1	1.1	0.9
ponderosa pine	1.0	1.0	1.0
other	1.0	1.0	1.0

Table 4.4—Wood density (ovendry lb/ft³) used in the NI-FFE variant.

Species	Density (lb/ft ³)
western white pine	24.8
western larch	34.3
Douglas-fir	31.9
grand fir	24.1
western hemlock	29.5
western redcedar	21.1
lodgepole pine	26.4
Engelmann spruce	22.6
subalpine fir	21.1
ponderosa pine	26.4
other	29.5

Fuels are divided into to four categories: live tree bole, live tree crown, live herb and shrub, and down woody debris (DWD). Live herb and shrub fuel load, and initial DWD are assigned based on the cover species with greatest basal area. If there is no basal area in the first simulation cycle (a “bare ground” stand), then the initial fuel loads are assigned by the vegetation code provided with the **STDINFO** keyword. If the vegetation code is missing or does not identify an overstory species, the model uses a ponderosa pine cover type to assign the default fuels. If there is no basal area in other cycles of the simulation (after a simulated clearcut, for example), herb and shrub fuel biomass is assigned by the previous cover type.

Live Tree Bole: The fuel contribution of live trees is divided into two components: bole and crown. Bole volume is transferred to the FFE after being computed by the FVS model, then converted to biomass using oven-dry wood density calculated from table 4-3a and equation 3-5 of *The Wood Handbook* (Forest Products Laboratory 1999) (table 4.4). The coefficient in table 4.4 for Douglas-fir is based on Douglas-fir Interior north.

Tree Crown: As described in the section 2.2 of the FFE “Model Description” chapter, equations in Brown and Johnston (1976) provide estimates of live and dead crown material for most species in the NI-FFE (table 4.5). Mountain hemlock biomass is based on Gholz (1979), using western hemlock equations from Brown and Johnston to partition the biomass and also to provide estimates for trees less than 1 inch diameter.

Live leaf lifespan is used to simulate the contribution of needles and leaves to annual litter fall. Dead foliage and branch materials also contribute to litter fall, at the rates shown in table 4.6. Each year the inverse of the lifespan is added to the litter pool from each biomass category. Leaf lifespan data are from Keane and others (1989). Lifespans of western white pine and mountain hemlock are mapped using ponderosa pine, and western hemlock and western redcedar are based on Douglas-fir.

Live Herbs and Shrubs: Live herb and shrub fuels are modeled simply by the FFE. Shrubs and herbs are assigned a biomass value based on total tree canopy cover and dominant overstory species (table 4.7). When there are

Table 4.5—The crown biomass equations listed here determine the biomass of foliage, branch and stem wood. Species mappings are done for species for which equations are not available.

Species	Species mapping and equation source
western white pine	Brown and Johnston (1976)
western larch	Brown and Johnston (1976)
Douglas-fir	Brown and Johnston (1976)
grand fir	Brown and Johnston (1976)
western hemlock	Brown and Johnston (1976)
western redcedar	Brown and Johnston (1976)
lodgepole pine	Brown and Johnston (1976)
Engelmann spruce	Brown and Johnston (1976)
subalpine fir	Brown and Johnston (1976)
ponderosa pine	Brown and Johnston (1976)
other	Gholz (1979); Brown and Johnston (1976)

Table 4.6—Life span of live and dead foliage (years) and dead branches for species modeled in the NI-FFE variant.

Species	Live	Dead			
	Foliage	Foliage	<0.25"	0.25–1"	>1"
western white pine	4	2	5	5	15
western larch	1	1	5	5	15
Douglas-fir	5	2	5	5	15
grand fir	7	2	5	5	15
western hemlock	5	2	5	5	15
western redcedar	5	2	5	5	20
lodgepole pine	3	2	5	5	15
Engelmann spruce	6	2	5	5	10
subalpine fir	7	2	5	5	15
ponderosa pine	4	2	5	5	10
other	4	2	5	5	15

Table 4.7—Values (dry weight, tons/acre) for live fuels used in the NI-FFE. Biomass is linearly interpolated between the “initiating” (I) and “established” (E) values when canopy cover is between 10 and 60 percent.

Species		Herbs	Shrubs	Notes
western white pine	E	0.15	0.10	
	I	0.30	2.00	
western larch	E	0.20	0.20	
	I	0.40	2.00	
Douglas-fir	E	0.20	0.20	
	I	0.40	2.00	
grand fir	E	0.15	0.10	
	I	0.30	2.00	
western hemlock	E	0.20	0.20	Use Douglas-fir
	I	0.40	2.00	
western redcedar	E	0.20	0.20	Use Douglas-fir
	I	0.40	2.00	
lodgepole pine	E	0.20	0.10	
	I	0.40	1.00	
Engelmann spruce	E	0.15	0.20	
	I	0.30	2.00	
subalpine fir	E	0.15	0.20	
	I	0.30	2.00	
ponderosa pine	E	0.20	0.25	
	I	0.25	0.10	
other	E	0.15	0.20	Use spruce-subalpine fir
	I	0.30	2.00	

no trees, habitat type is used to infer the most likely dominant species of the previous stand (“Model Description” chapter, section 2.4.2). When total tree canopy cover is less than 10 percent, herb and shrub biomass is assigned an “initiating” value (the ‘I’ rows from table 4.7). When canopy cover is greater than 60 percent, biomass is assigned an “established” value (the ‘E’ rows). Live fuel loads are linearly interpolated when canopy cover is between 10 and 60 percent. Data are taken from FOFEM 4.0 (Reinhardt and others 1997) with modifications provided by Jim Brown (USFS Missoula, MT pers. comm. 1995).

Dead Fuels: Initial default DWD pools are based on overstory species. When there are no trees, habitat type is used to infer the most likely dominant species of the previous stand (“Model Description” chapter, section 2.4.2). Default fuel loadings were provided by Jim Brown (USFS, Missoula, MT pers. comm. 1995) (table 4.8). If tree canopy cover is less than 10 percent, the DWD pools are assigned an “initiating” value; and if cover is greater than 60 percent they are assign the “established” value. Fuels are linearly interpolated when canopy cover is between 10 and 60 percent. Initial fuel loads can be modified using the **FUELINIT** keyword.

4.2.4 Bark Thickness

Bark thickness contributes to predicted tree mortality from simulated fires. The bark thickness multipliers in table 4.9 are used to calculate single bark thickness (“Model Description” chapter, section 2.5.5). The bark thickness equation used in the mortality equation is unrelated to the bark thickness used in the base FVS model. Data are from FOFEM 5.0 (Reinhardt and others 2001).

4.2.5 Decay Rate

Decay of down material is simulated by applying loss rates to biomass in categories based on the original size-class of the branch and bole pieces as described in section 2.4.5 of the “Model Description” chapter (table 4.10). Default decay rates are based on Abbott and Crossley (1982). A portion of the loss is added to the duff pool each year. Loss rates are for hard material; soft material in all size classes, except litter and duff, decays 10 percent faster.

Table 4.8—Canopy cover and cover type are used to assign default down woody debris (tons/acre) by size class for established (E) and initiating (I) stands.

Species		Size class (inches)						Litter	Duff
		< 0.25	0.25 – 1	1 – 3	3 – 6	6 – 12	> 12		
western white pine	E	1.0	1.0	1.6	10.0	10.0	10.0	0.8	30.0
	I	0.6	0.6	0.8	6.0	6.0	6.0	0.4	12.0
western larch	E	0.9	0.9	1.6	3.5	3.5	0.0	0.6	10.0
	I	0.5	0.5	1.0	1.4	1.4	0.0	0.3	5.0
Douglas-fir	E	0.9	0.9	1.6	3.5	3.5	0.0	0.6	10.0
	I	0.5	0.5	1.0	1.4	1.4	0.0	0.3	5.0
grand fir	E	0.7	0.7	3.0	7.0	7.0	0.0	0.6	25.0
	I	0.5	0.5	2.0	2.8	2.8	0.0	0.3	12.0
western hemlock	E	2.2	2.2	5.2	15.0	20.0	15.0	1.0	35.0
	I	1.6	1.6	3.6	6.0	8.0	6.0	0.5	12.0
western redcedar	E	2.2	2.2	5.2	15.0	20.0	15.0	1.0	35.0
	I	1.6	1.6	3.6	6.0	8.0	6.0	0.5	12.0
lodgepole pine	E	0.9	0.9	1.2	7.0	8.0	0.0	0.6	15.0
	I	0.6	0.7	0.8	2.8	3.2	0.0	0.3	7.0
Engelmann spruce	E	1.1	1.1	2.2	10.0	10.0	0.0	0.6	30.0
	I	0.7	0.7	1.6	4.0	4.0	0.0	0.3	12.0
subalpine fir	E	1.1	1.1	2.2	10.0	10.0	0.0	0.6	30.0
	I	0.7	0.7	1.6	4.0	4.0	0.0	0.3	12.0
ponderosa pine	E	0.7	0.7	1.6	2.5	2.5	0.0	1.4	5.0
	I	0.1	0.1	0.2	0.5	0.5	0.0	0.5	0.8
other	E	1.1	1.1	2.2	10.0	10.0	0.0	0.6	30.0
	I	0.7	0.7	1.6	4.0	4.0	0.0	0.3	12.0

Table 4.9—Species specific constants for determining single bark thickness.

Species	Multiplier (V_{sp})
western white pine	0.035
western larch	0.063
Douglas-fir	0.063
grand fir	0.046
western hemlock	0.040
western redcedar	0.035
lodgepole pine	0.028
Engelmann spruce	0.036
subalpine fir	0.041
ponderosa pine	0.063
other	0.040

Table 4.10—Default annual loss rates are applied based on size class. A portion of the loss is added to the duff pool each year. Loss rates are for hard material. If present, soft material in all size classes except litter and duff decays 10 percent faster.

Size class (inches)	Annual loss rate	Proportion of loss becoming duff
< 0.25	0.12	
0.25 — 1		
1 — 3	0.09	
3 — 6		0.02
6 — 12	0.015	
> 12		
Litter	0.50	
Duff	0.002	0.0

By default, the FFE decays all wood species at the rates shown in table 4.10. The decay rates of species groups may be modified by users, who can provide rates to the four decay classes shown in table 4.11 using the **FUELDCAY** keyword. Users can also reassign species to different classes using the **FUELPOOL** keyword.

4.2.6 Moisture Content

Moisture content of the live and dead fuels is used to calculate fire intensity and fuel consumption (“Model Description” chapter, section 2.5.2). Users can choose from four predefined moisture groups (table 4.12) or they can specify moisture conditions for each class using the **MOISTURE** keyword.

Table 4.11—Default wood decay classes used in the NI-FFE variant. Classes are from The Wood Handbook (1999). (1 = exceptionally high; 2 = resistant or very resistant; 3 = moderately resistant, and 4 = slightly or nonresistant.)

Species	Decay class
western white pine	4
western larch	3
Douglas-fir	3
grand fir	4
western hemlock	4
western redcedar	2
lodgepole pine	4
Engelmann spruce	4
subalpine fir	4
ponderosa pine	4
other	4

Table 4.12—Moisture values, which alter fire intensity and consumption, have been predefined for four groups.

Size class	Moisture group			
	Very dry	Dry	Moist	Wet
0 – 0.25 in. (1-hr)	4	8	12	16
0.25 – 1.0 in. (10-hr)	4	8	12	16
1.0 – 3.0 in. (100-hr)	5	10	14	18
> 3.0 in. (1000+ -hr)	10	15	25	50
Duff	15	50	125	200
Live	70	110	150	150

4.2.7 Fire Behavior Fuel Models

Fire behavior fuel models (Anderson 1982) are used to estimate flame length and fire effects stemming from flame length. Fuel models are determined using fuel load and stand attributes (“Model Description” chapter, section 2.4.8) specific to each FFE variant. In addition, stand management actions such as thinning and harvesting can abruptly increase fuel loads and can trigger “Activity Fuels” conditions, resulting in the selection of alternative fuel models. At their discretion, FFE users have the option of:

1. Defining and using their own fuel models
2. Defining the choice of fuel models and weights
3. Allowing the FFE variant to determine a weighted set of fuel models
4. Allowing the FFE variant to determine a weighted set of fuel models, then using the dominant model

This section explains the steps taken by the NI-FFE to follow the third and fourth of these four options.

When the combination of large and small fuel lies in the lower left corner of the graph shown in figure 4.1, one or more low-fuel fuel models become candidate models. In other regions of the graph, other fuel models may also be candidates. The habitat types shown in table 4.13 define which low fuel model(s) will become candidates. According to the logic of this table, only a single fuel model will be chosen for a given stand structure. Consequently, as a stand undergoes structural changes due to management or maturation, the selected fire model can jump from one model selection to another, which in turn may cause abrupt changes in predicted fire behavior. To smooth out changes resulting from changes in fuel model, the strict logic is augmented by linear transitions between states that involve continuous variables (for example, percent canopy cover, average height, snag density, and so forth).

If the **STATFUEL** keyword is selected, fuel model is determined by using only the closest match fuel model identified by either figure 4.1 or table 4.13. The **FLAMEADJ** keyword allows the user to scale the calculated flame length or override the calculated flame length with a value they choose.

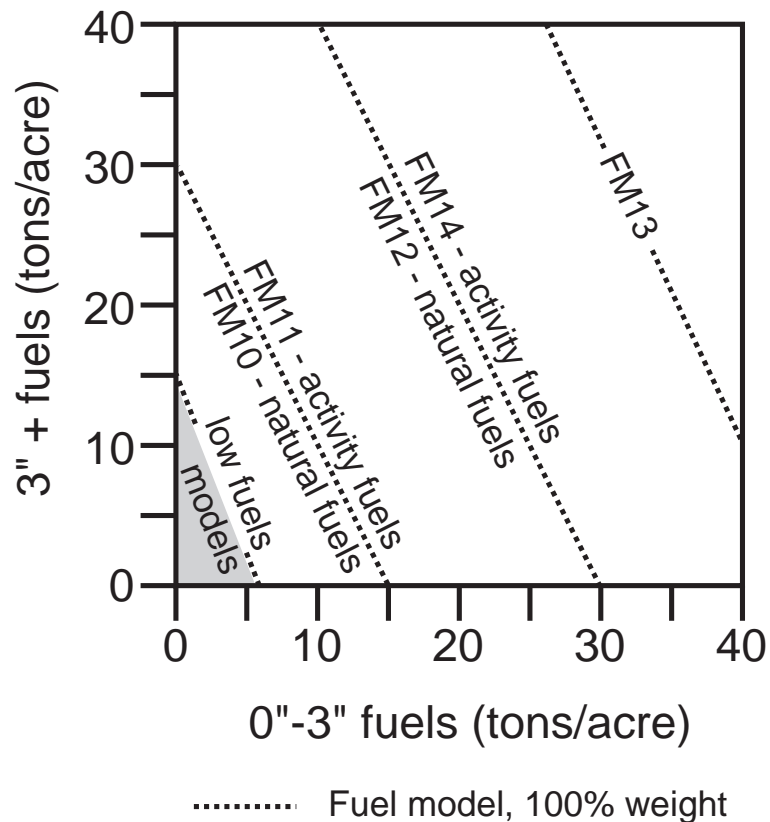

Figure 4.1—If large and small fuels map to the shaded area, candidate fuel models are determined using the logic shown in table 4.13. Otherwise, flame length based on distance between the closest fuel models, identified by the dashed lines, and on recent management (see “Model Description” chapter, section 2.4.8 for further details).

Table 4.13—When low fuel loads are present in the NI-FFE, fire behavior fuel models are determined using one of three habitat groups: dry grassy, dry shrubby, and other. Fuel model is linearly interpolated between the two low fuel models when canopy cover falls between 30 and 50 percent.

Habitat type number	Habitat type name	FFE habitat category	Canopy cover	Canopy
			< 30%	cover > 50%
			Fuel model	
130	PIPO/AGSP	Dry Grassy	1	9
140	PIPO/FEID			
210	PSME/AGSP			
220	PSME/FEID			
230	PSME/FESC			
161	PIPO/PUTR	Dry Shrubby	2	9
170	PIPO/SYAL			
171	PIPO/SYAL-SYAL			
172	PIPO/SYAL-BERE			
180	PIPO/PRVI			
181	PIPO/PRVI-PRVI			
182	PIPO/PRVI-SHCA			
310	PSME/SYAL			
311	PSME/SYAL-AGSP			
312	PSME/SYAL-CARU			
313	PSME/SYAL-SYAL			
All others		Other	8	8

4.3 Eastern Montana (EM)

4.3.1 Tree Species

The Eastern Montana variant models the seven tree species shown in table 4.14. One additional category, “other” is modeled using western juniper.

4.3.2 Snags

The majority of the snag model logic is based on unpublished data provided by Bruce Marcot (USFS, Portland, OR, unpublished data 1995). Snag fall parameters were developed at the FFE design workshop. A complete description of the Snag Submodel is provided in section 2.3 of the FFE “Model Description” chapter.

Four variables are used to modify the Snag Submodel for the different species in the EM-FFE variant:

- A multiplier to modify the species’ fall rate
- A multiplier to modify the time required for snags to decay from a “hard” to “soft” state
- The maximum number of years that snags will remain standing
- A multiplier to modify the species’ height loss rate

These variables are summarized in tables 4.15 and 4.16.

Table 4.14—Tree species simulated by the Eastern Montana variant.

Common name	Scientific name	Notes
whitebark pine	<i>Pinus albicaulis</i>	
western larch	<i>Larix occidentalis</i>	
Douglas-fir	<i>Pseudotsuga menziesii</i>	
lodgepole pine	<i>Pinus contorta</i>	
Engelmann spruce	<i>Picea engelmannii</i>	
subalpine fir	<i>Abies lasiocarpa</i>	
ponderosa pine	<i>Pinus ponderosa</i>	
other		= western juniper

Table 4.15—Default snag fall, snag height loss and soft-snag characteristics for 20 inch DBH snags in the EM-FFE variant. These characteristics are derived directly from the parameter values shown in table 4.16.

Species	95% fallen	All down	50% height	Hard-to-soft
	-----Year-----			
whitebark pine	34	110	33	42
western larch	34	110	33	42
Douglas-fir	34	110	33	42
lodgepole pine	28	90	27	35
Engelmann spruce	28	90	27	35
subalpine fir	28	90	27	35
ponderosa pine	31	100	30	39
other	31	100	30	39

Table 4.16—Default snag fall, snag height loss and soft-snag multipliers for the EM-FFE. These parameters result in the values shown in table 4.15. (These three columns are the default values used by the SNAGFALL, SNAGBRK, and SNAGDCAY keywords, respectively.)

Species	Snag fall	Height loss	Hard-to-soft
whitebark pine	0.9	0.9	1.1
western larch	0.9	0.9	1.1
Douglas-fir	0.9	0.9	1.1
lodgepole pine	1.1	1.1	0.9
Engelmann spruce	1.1	1.1	0.9
subalpine fir	1.1	1.1	0.9
ponderosa pine	1.0	1.0	1.0
other	1.0	1.0	1.0

Snag bole volume is determined in using the base FVS model equations. The coefficients shown in table 4.17 are used to convert volume to biomass. Soft snags have 80 percent the density of hard snags.

Snag dynamics can be modified by the user using the **SNAGBRK**, **SNAGFALL**, **SNAGDCAY** and **SNAGPBN** keywords described in the FFE “Model Description” chapter.

Additionally, the base fall rate diameter cutoff (diameter at which 5 percent of snags are assigned a slower fall rate) was changed from 18 inches to 12 inches DBH and the fire fall rate cutoff (diameter at which 90 percent of the smaller snags are assigned a faster fall rate after fire) was changed from 12 inches to 10 inches DBH. Both of these changes were made to better represent the smaller trees modeled in the EM variant.

4.3.3 Fuels

Information on live fuels was developed using FOFEM 4.0 (Reinhardt and others 1997) and FOFEM 5.0 (Reinhardt and others 2001) and in cooperation with Jim Brown (USFS, Missoula, MT pers. comm. 1995). A complete description of the Fuel Submodel is provided in section 2.4 of the FFE “Model Description” chapter.

Table 4.17—Wood density (ovendry lb/ft³) used in the EM-FFE variant.

Species	Density (lb/ft ³)
whitebark pine	24.8
western larch	34.3
Douglas-fir	31.9
lodgepole pine	26.4
Engelmann spruce	22.6
subalpine fir	21.1
ponderosa pine	26.4
other	34.9

Fuels are divided into to four categories: live tree bole, live tree crown, live herb and shrub, and down woody debris (DWD). Live herb and shrub fuel load, and initial DWD are assigned based on the cover species with greatest basal area. If there is no basal area in the first simulation cycle (a “bare ground” stand) then the initial fuel loads are assigned by the vegetation code provided with the **STDINFO** keyword. If the vegetation code is missing or does not identify an overstory species, the model uses a ponderosa pine cover type to assign the default fuels. If there is no basal area in other cycles of the simulation (after a simulated clearcut, for example) herb and shrub fuel biomass is assigned by the previous cover type.

Live Tree Bole: The fuel contribution of live trees is divided into two components: bole and crown. Bole volume is transferred to the FFE after being computed by the FVS model, then converted to biomass using oven-dry wood density calculated from table 4-3a and equation 3-5 of *The Wood Handbook* (Forest Products Laboratory 1999). The coefficient in table 4.17 for whitebark pine is based on western white pine; Douglas-fir is based on Douglas-fir Interior north.

Live Tree Crown: As described in the section 2.2 of the FFE “Model Description” chapter, equations in Brown and Johnston (1976) provide estimates of live and dead crown material for most species in the EM-FFE (table 4.18). Western juniper (‘other’) equations are based on a single-stem form.

Live leaf lifespan is used to simulate the contribution of needles and leaves to annual litter fall. Dead foliage and branch materials also contribute to litter fall, at the rates shown in table 4.19. Each year the inverse of the lifespan is added to the litter pool from each biomass category. Leaf lifespan data are from Keane and others (1989). Lifespan of western white pine is assumed to be the same as ponderosa pine.

Live Herbs and Shrub: Live herb and shrub fuels are modeled simply by the FFE. Shrubs and herbs are assigned a biomass value based on total tree canopy cover and dominant overstory species (table 4.20). When there are no trees, habitat type is used to infer the most likely dominant species of the previous stand (“Model Description” chapter, section 2.4.2). When total tree canopy cover is less than 10 percent, herb and shrub biomass is assigned an “initiating” value (the ‘I’ rows from table 4.20). When canopy cover is greater than 60 percent, biomass is assigned an “established” value (the ‘E’

Table 4.18—The crown biomass equations listed here determine the biomass of foliage, branch, and stem wood.

Species	Species mapping and equation source
whitebark pine	Brown (1978)
western larch	Brown and Johnston (1976)
Douglas-fir	Brown and Johnston (1976)
lodgepole pine	Brown and Johnston (1976)
Engelmann spruce	Brown and Johnston (1976)
subalpine fir	Brown and Johnston (1976)
ponderosa pine	Brown and Johnston (1976)
other	Chojnacky (1992), Grier and others (1992)

Table 4.19—Life span of live and dead foliage (years) and dead branches for species modeled in the EM-FFE variant.

Species	Live	Dead			
	Foliage	Foliage	<0.25"	0.25–1"	>1"
whitebark pine	7	2	5	5	15
western larch	1	1	5	5	15
Douglas-fir	5	2	5	5	15
lodgepole pine	3	2	5	5	15
Engelmann spruce	6	2	5	5	10
subalpine fir	7	2	5	5	15
ponderosa pine	4	2	5	5	10
other	4	2	5	5	20

Table 4.20—Values (dry weight, tons/acre) for live fuels used in the EM-FFE. Biomass is linearly interpolated between the “initiating” (I) and “established” (E) values when canopy cover is between 10 and 60 percent

Species		Herbs	Shrubs	Notes
whitebark pine	E	0.20	0.05	
	I	0.40	0.50	
western larch	E	0.20	0.10	
	I	0.40	1.00	
Douglas-fir	E	0.20	0.10	
	I	0.40	1.00	
lodgepole pine	E	0.20	0.05	
	I	0.40	0.50	
Engelmann spruce	E	0.15	0.10	
	I	0.30	1.00	
subalpine fir	E	0.15	0.10	
	I	0.30	1.00	
ponderosa pine	E	0.20	0.12	
	I	0.25	0.05	
other	E	0.04	0.05	Ottmar and others (2000a)
	I	0.13	1.63	

rows). Live fuel loads are linearly interpolated when canopy cover is between 10 and 60 percent. Data are taken from FOFEM 4.0 (Reinhardt and others 1997) with modifications provided by Jim Brown (USFS, Missoula, MT pers. comm., 1995).

Dead Fuels: Initial default DWD pools are based on overstory species. When there are no trees, habitat type is used to infer the most likely dominant species of the previous stand (“Model Description” chapter, section 2.4.2). Default fuel loadings were provided by Jim Brown (USFS, Missoula, MT pers. comm., 1995) (table 4.21). If tree canopy cover is less than 10 percent, the DWD pools are assigned an “initiating” value, and if cover is greater than 60 percent they are assigned the “established” value. Fuels are linearly interpolated when canopy cover is between 10 and 60 percent. Initial fuel loads can be modified using the **FUELINIT** keyword.

Table 4.21—Canopy cover and cover type are used to assign default down woody debris (tons/acre) by size class for established (E) and initiating (I) stands.

Species		Size class (inches)						Litter	Duff
		< 0.25	0.25 – 1	1 – 3	3 – 6	6 – 12	> 12		
whitebark pine	E	0.9	0.9	1.2	7.0	8.0	0.0	0.6	15.0
	I	0.6	0.7	0.8	2.8	3.2	0.0	0.3	7.0
western larch	E	0.9	0.9	1.6	3.5	3.5	0.0	0.6	10.0
	I	0.5	0.5	1.0	1.4	1.4	0.0	0.3	5.0
Douglas-fir	E	0.9	0.9	1.6	3.5	3.5	0.0	0.6	10.0
	I	0.5	0.5	1.0	1.4	1.4	0.0	0.3	5.0
lodgepole pine	E	0.9	0.9	1.2	7.0	8.0	0.0	0.6	15.0
	I	0.6	0.7	0.8	2.8	3.2	0.0	0.3	7.0
Engelmann spruce	E	1.1	1.1	2.2	10.0	10.0	0.0	0.6	30.0
	I	0.7	0.7	1.6	4.0	4.0	0.0	0.3	12.0
subalpine fir	E	1.1	1.1	2.2	10.0	10.0	0.0	0.6	30.0
	I	0.7	0.7	1.6	4.0	4.0	0.0	0.3	12.0
ponderosa pine	E	0.7	0.7	1.6	2.5	2.5	0.0	1.4	5.0
	I	0.1	0.1	0.2	0.5	0.5	0.0	0.5	0.8
other	E	0.2	0.8	2.3	1.4	3.0	0.0	9.3	0.0
	I	0.0	0.1	0.0	0.0	0.0	0.0	2.0	0.0

4.3.4 Bark Thickness

Bark thickness contributes to predicted tree mortality from simulated fires. The bark thickness multipliers in table 4.22 are used to calculate single bark thickness (“Model Description” chapter, section 2.5.5). The bark thickness equation used in the mortality equation is unrelated to the bark thickness used in the base FVS model. Data are from FOFEM 5.0 (Reinhardt and others 2001).

4.3.5 Decay Rate

Decay of down material is simulated by applying loss rates to biomass in categories based on the original size-class of the branch and bole pieces as described in section 2.4.5 of the “Model Description” chapter (table 4.23). Default decay rates are based on Abbott and Crossley (1982). A portion of the loss is added to the duff pool each year. Loss rates are for hard material; soft material in all size classes, except litter and duff, decays 10 percent faster.

By default, the FFE decays all wood species at the rates shown in table 4.23. The decay rates of species groups may be modified by users, who can provide rates to the four decay classes shown in table 4.24 using the **FUELDCAY** keyword. Users can also reassign species to different classes using the **FUELPOOL** keyword.

Table 4.22—Species specific constants for determining single bark thickness.

Species	Multiplier (V_{sp})
whitebark pine	0.030
western larch	0.063
Douglas-fir	0.063
lodgepole pine	0.028
Engelmann spruce	0.036
subalpine fir	0.041
ponderosa pine	0.063
other	0.025

Table 4.23—Default annual loss rates are applied based on size class. A portion of the loss is added to the duff pool each year. Loss rates are for hard material. If present, soft material in all size classes except litter and duff decays 10 percent faster.

Size class (inches)	Annual loss rate	Proportion of loss becoming duff
< 0.25	0.12	
0.25 — 1		
1 — 3	0.09	
3 — 6		0.02
6 — 12	0.015	
> 12		
Litter	0.50	
Duff	0.002	0.0

4.3.6 Moisture Content

Moisture content of the live and dead fuels is used to calculate fire intensity and fuel consumption (“Model Description” chapter, section 2.5.2). Users can choose from four predefined moisture groups (table 4.25) or they can specify moisture conditions for each class using the **MOISTURE** keyword.

4.3.7 Fire Behavior Fuel Models

Fire behavior fuel models (Anderson 1982) are used to estimate flame length and fire effects stemming from flame length. Fuel models are determined using fuel load and stand attributes (“Model Description” chapter,

Table 4.24—Default wood decay classes used in the EM-FFE variant. Classes are from *The Wood Handbook* (1999). (1 = exceptionally high; 2 = resistant or very resistant; 3 = moderately resistant, and 4 = slightly or nonresistant)

Species	Decay class
whitebark pine	4
western larch	3
Douglas-fir	3
lodgepole pine	4
Engelmann spruce	4
subalpine fir	4
ponderosa pine	4
other	2

Table 4.25—Moisture values, which alter fire intensity and consumption, have been predefined for four groups.

Size class	Moisture group			
	Very dry	Dry	Moist	Wet
0 – 0.25 in. (1-hr)	4	8	12	16
0.25 – 1.0 in. (10-hr)	4	8	12	16
1.0 – 3.0 in. (100-hr)	5	10	14	18
> 3.0 in. (1000+ -hr)	10	15	25	50
Duff	15	50	125	200
Live	70	110	150	150

section 2.4.8) specific to each FFE variant. In addition, stand management actions such as thinning and harvesting can abruptly increase fuel loads and can trigger “Activity Fuels” conditions, resulting in the selection of alternative fuel models. At their discretion, FFE users have the option of:

1. Defining and using their own fuel models
2. Defining the choice of fuel models and weights
3. Allowing the FFE variant to determine a weighted set of fuel models
4. Allowing the FFE variant to determine a weighted set of fuel models, then using the dominant model

This section explains the steps taken by the EM-FFE to follow the third and fourth of these four options.

When the combination of large and small fuel lies in the lower left corner of the graph shown in figure 4.2, one or more low-fuel fuel models become candidate models. In other regions of the graph, other fuel models may also be candidates. The habitat types shown in table 4.26 define which of eight groups of low fuel model(s) will become candidates. According to the logic of the table, only a single fuel model will be chosen for a given stand structure. Consequently, as a stand undergoes structural changes due to management or maturation, the selected fire model can jump from one model selection to another, which in turn may cause abrupt changes in predicted fire behavior.

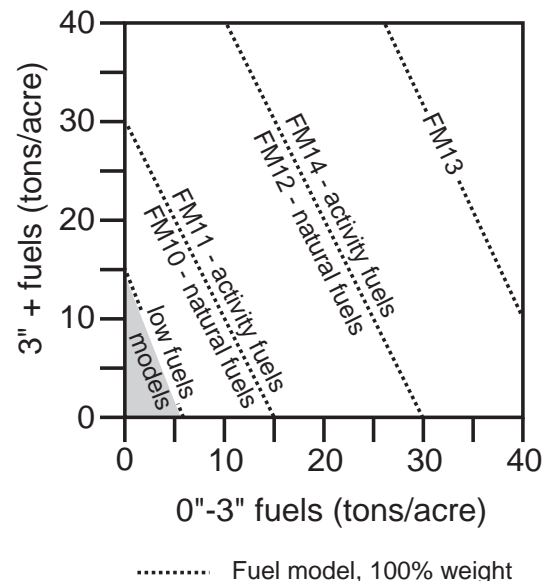

Figure 4.2—If large and small fuels map to the shaded area, candidate fuel models are determined using the logic shown in table 4.26. Otherwise, flame length is based on the distance to the closest fuel models, identified by the dashed lines, and on recent management (see “Model Description” chapter, section 2.4.8 for further details).

To smooth out changes resulting from changes in fuel model, the strict logic is augmented by linear transitions between states that involve continuous variables (for example, percent canopy cover, average height, snag density, and so forth).

If the **STATFUEL** keyword is selected, fuel model is determined using only the closest-match fuel model identified by either figure 4.2 or table 4.26. The **FLAMEADJ** keyword allows the user to scale the calculated flame length or override the calculated flame length with a value they choose.

Table 4.26—When low fuel loads are present in the EM-FFE, fire behavior fuel models are determined using one of eight habitat categories: scree, dry grassy, grassy tall shrub, grassy shrub, long needle shrubby, short needle shrubby, short needle grassy, and other. Fuel model is linearly interpolated between the two low fuel models when canopy cover falls between 30 and 50 percent.

Habitat type number	Habitat type name	FFE habitat category	Tree cover	Tree cover
			< 30 percent	> 50 percent
			Fuel Model	
10	scree	Scree	8	8
66	Unknown	Dry Grassy	1	2
70	PIFL/JUCO	Grassy Tall Shrub	2	6
74	Unknown	Dry Grassy	1	2
79	Unknown			
91	Unknown			
92	Unknown			
93	Unknown			
95	Unknown			
100	PIPO			
110	PIPO-AND			
120	Unknown			
130	PIPO-AGSP			
140	PIPO-FEID			
141	PIPO-FEID-FEID			
161	PIPO-PUTR-AGSP	Grassy Shrub	1	9
170	PIPO-SYAL	Long Needle Shrubby	2	9
171	PIPO-SYAL-SYAL			
172	PIPO-SYAL-BERE			
180	PIPO-PRVI	Grassy Tall Shrub	2	6

Table 4.26 (Con.)

Habitat type number	Habitat type name	FFE habitat category	Tree cover	Tree cover
			< 30 percent	> 50 percent
			Fuel Model	
181	PIPO-PRVI-PRVI			
182	PIPO-PRVI-SHCA			
200	PSME	Short Needle Shrubby	2	8
210	PSME-AGSP	Short Needle Grassy	1	8
220	PSME-FEID			
221	Unknown			
230	PSME-FESC			
250	PSME-VACA	Short Needle Shrubby	2	8
260	PSME-PHMA			
261	PSME-PHMA-PHMA			
262	PSME-PHMA-CARU			
280	PSME-VAGL			
281	PSME-VAGL-VAGL			
282	PSME-VAGL-ARUV			
283	PSME-VAGL-XETE			
290	PSME-LIBO			
291	PSME-LIBO-SYAL			
292	PSME-LIBO-CARU			
293	PSME-LIBO-VAGL			
310	PSME-SYAL			
311	PSME-SYAL-AGSP			
312	PSME-SYAL-CARU			
313	PSME-SYAL-SYAL			
315	Unknown			
320	PSME-CARU			

Table 4.26 (Con.)

Habitat type number	Habitat type name	FFE habitat category	Tree cover	Tree cover
			< 30 percent	> 50 percent
			Fuel Model	
321	PSME-CARU-AGSP			
322	PSME-CARU-ARUV			
323	PSME-CARU-CARU			
330	PSME-CAGE			
331	Unknown			
332	Unknown			
340	PSME-SPBE			
350	PSME-ARUV			
360	PSME-JUCO			
370	PSME-ARCO			
371	Unknown			
All others		Other	5	8

4.4 Southern Oregon/Northern California (SO)

4.4.1 Tree Species

The Southern Oregon/Northern California (SORNEC) variant models the 10 tree species shown in table 4.27. White fir and grand fir are modeled together as one species, as are red fir and subalpine fir. One additional category, “other” is modeled using western juniper.

4.4.2 Snags

The majority of the snag model logic is based on unpublished data provided by Bruce Marcot (USFS, Portland, OR, unpublished data 1995). Snag fall parameters were originally developed at the SO-FFE workshop. Parameters for California stands were revised at a California variants workshop (Stephanie Rebain, personal communication, February 2003). A complete description of the Snag Submodel is provided in section 2.3 of the FFE “Model Description” chapter.

Four variables are used to modify the Snag Submodel for the different species in the SO-FFE variant:

- A multiplier to modify the species’ fall rate
- A multiplier to modify the time required for snags to decay from a “hard” to “soft” state
- The maximum number of years that snags will remain standing
- A multiplier to modify the species’ height loss rate

These variables are summarized in tables 4.28 and 4.29.

Snag bole volume is determined in using the base FVS model equations. The coefficients shown in table 4.30 are used to convert volume to biomass. Soft snags have 80 percent the density of hard snags. Ponderosa pine trees break extremely slowly in regions modeled by the SO-FFE, so the height loss rate was changed to 0.3 from 1.0 (the value used by the NI-FFE).

Table 4.27—Tree species simulated by the Southern Oregon/Northern California variant.

Common name	Scientific name	Notes
western white pine	<i>Pinus monticola</i>	
sugar pine	<i>Pinus lambertiana</i>	
Douglas-fir	<i>Pseudotsuga menziesii</i>	
white fir, grand fir	<i>Abies concolor</i> , <i>A. grandis</i>	
mountain hemlock	<i>Tsuga mertensiana</i>	
incense-cedar	<i>Calocedrus decurrens</i>	= <i>Libocedrus decurrens</i>
lodgepole pine	<i>Pinus contorta</i>	
Engelmann spruce	<i>Picea engelmannii</i>	
red fir, subalpine fir	<i>Abies magnifica</i> , <i>A. lasiocarpa</i>	
ponderosa pine	<i>Pinus ponderosa</i>	
other		= western juniper

Table 4.28—Default snag fall, snag height loss and soft-snag characteristics for 20 inch DBH snags in the SO-FFE variant. These characteristics are derived directly from the parameter values shown in table 4.29.

Species	95% fallen	All down	50% height	Hard-to-soft
----- <i>Years</i> -----				
Oregon				
western white pine	34	110	33	42
sugar pine	34	110	33	42
Douglas-fir	34	110	33	42
white fir, grand fir	28	90	27	35
mountain hemlock	28	90	27	35
incense-cedar	28	90	27	35
lodgepole pine	28	90	27	35
Engelmann spruce	28	90	27	35
red fir, subalpine fir	28	90	27	35
ponderosa pine	31	100	100	39
other	31	100	30	39
California				
western white pine	25	100	20	—
sugar pine	25	100	20	—
Douglas-fir	35	100	20	—
white fir, grand fir	35	100	20	—
mountain hemlock	25	100	20	—
incense-cedar	45	100	20	—
lodgepole pine	25	100	20	—
Engelmann spruce	35	100	20	—
red fir, subalpine fir	35	100	20	—
ponderosa pine	25	100	20	—
other	45	150	20	—

4.4.3 Fuels

Information on live fuels was developed using FOFEM 4.0 (Reinhardt and others 1997) and FOFEM 5.0 (Reinhardt and others 2001) and in cooperation with Jim Brown (USFS, Missoula, MT pers. comm. 1995). A complete description of the Fuel Submodel is provided in section 2.4 of the FFE “Model Description” chapter.

Fuels are divided into to four categories: live tree bole, live tree crown, live herb and shrub, and down woody debris (DWD). Live herb and shrub fuel load, and initial DWD are assigned based on the cover species with greatest basal area. If there is no basal area in the first simulation cycle (a “bare ground” stand) then the initial fuel loads are assigned by the vegetation code provided with the **STDINFO** keyword. If the vegetation code is missing or does not identify an overstory species, the model uses a ponderosa pine cover type to assign the default fuels. If there is no basal area in other cycles of the simulation (after a simulated clearcut, for example) herb and shrub fuel biomass is assigned by the previous cover type.

Live Tree Bole: The fuel contribution of live trees is divided into two components: bole and crown. Bole volume is transferred to the FFE after being computed by the FVS model, then converted to biomass using oven-dry wood density calculated from table 4-3a and equation 3-5 of The Wood

Table 4.29—Default snag fall, snag height loss and soft-snag multipliers for the SO-FFE. These parameters result in the values shown in table 4.28. (These three columns are the default values used by the SNAGFALL, SNAGBRK, and SNAGDCAY keywords, respectively.)

Species	Snag fall	Height loss	Hard-to-soft
Oregon			
western white pine	0.9	0.9	1.1
sugar pine	0.9	0.9	1.1
Douglas-fir	0.9	0.9	1.1
white fir, grand fir	1.1	1.1	0.9
mountain hemlock	1.1	1.1	0.9
incense-cedar	1.1	1.1	0.9
lodgepole pine	1.1	1.1	0.9
Engelmann spruce	1.1	1.1	0.9
red fir, subalpine fir	1.1	1.1	0.9
ponderosa pine	1.0	0.3	1.0
other	1.0	1.0	1.0
California			
western white pine	1.24	1.49	—
sugar pine	1.24	1.49	—
Douglas-fir	0.88	1.49	—
white fir, grand fir	0.88	1.49	—
mountain hemlock	1.24	1.49	—
incense-cedar	0.69	1.49	—
lodgepole pine	1.24	1.49	—
Engelmann spruce	0.88	1.49	—
red fir, subalpine fir	0.88	1.49	—
ponderosa pine	1.24	1.49	—
other	0.69	1.49	—

Table 4.30—Wood density (ovendry lb/ft³) used in the SO-FFE variant.

Species	Density (lb/ft ³)
western white pine	24.8
sugar pine	23.3
Douglas-fir	32.7
white fir, grand fir	25.6
mountain hemlock	29.5
incense-cedar	24.1
lodgepole pine	26.4
Engelmann spruce	22.6
red fir, subalpine fir	24.8
ponderosa pine	26.4
other	34.9

Handbook (Forest Products Laboratory 1999). The coefficients in table 4.30 for white fir/grand fir are based on white fir; Douglas-fir is based on Douglas-fir Interior west.

Tree Crown: As described in the section 2.2 of the FFE “Model Description” chapter, equations in Brown and Johnston (1976) provide estimates of live and dead crown material for most species in the SO-FFE. Some species mappings are used, as shown below in table 4.31. Mountain hemlock biomass is based on Gholz (1979), using western hemlock equations from Brown and Johnston to partition the biomass and also to provide estimates for trees less than one inch diameter. Juniper (“other”) equations are based on a single-stem form.

Live leaf lifespan is used to simulate the contribution of needles and leaves to annual litter fall. Dead foliage and branch materials also contribute to litter fall, at the rates shown in table 4.32. Each year the inverse of the lifespan is added to the litter pool from each biomass category. These data are from the values provided at the SO-FFE workshop and California variants model verification workshop (Stephanie Rebain, USFS, pers. comm. February 2003).

Live Herbs and Shrubs: Live herb and shrub fuels are modeled simply by the FFE. Shrubs and herbs are assigned a biomass value based on structural stage and cover type, using Fuel Characterization Classes (FCCs, Ottmar and others 1996). In each time step, selection of the FCC begins with the stand structure logic of Crookston and Stage (1999), embedded in FVS. The resulting Crookston and Stage classification is then converted to Ottmar’s classification system, using table 4.33. Cover type is then defined by the species with the greatest basal area. When there are no trees, habitat type is used to infer the most likely dominant species of the previous stand (“Model Description” chapter, section 2.4.2). The FCC is then assigned using table 4.34. Finally, shrub and herb loads are assigned using table 4.35 and are set to zero if the structural stage is undefined. The structural class rules used in the SO-FFE variant were first developed for the Interior Columbia River Basin Assessment (Hessburg and others 1999).

Table 4.31—The crown biomass equations listed here determine the biomass of foliage, branch, and stem wood. Species mappings are done for species for which equations are not available.

Species	Species mapping and equation source
western white pine	Brown and Johnston 1976
sugar pine	western white pine (Brown and Johnston 1976)
Douglas-fir	Brown and Johnston 1976
white fir, grand fir	grand fir (Brown and Johnston 1976)
mountain hemlock	Gholz (1979); western hemlock (Brown and Johnston 1976)
incense-cedar	western redcedar (Brown and Johnston 1976)
lodgepole pine	Brown and Johnston 1976
Engelmann spruce	Brown and Johnston 1976
red fir, subalpine fir	subalpine fir (Brown and Johnston 1976)
ponderosa pine	Brown and Johnston 1976
other	Chojnacky (1992), Grier and others (1992)

Table 4.32—Life span of live and dead foliage (years) and dead branches for species modeled in the SO-FFE variant.Oregon

Species	Live	Dead			
	Foliage	Foliage	<0.25"	0.25–1"	>1"
Oregon					
western white pine	4	2	5	5	15
sugar pine	3	2	5	5	15
Douglas-fir	5	2	5	5	15
white fir, grand fir	7	2	5	5	15
Mountain hemlock	4	2	5	5	15
incense-cedar	5	1	5	5	20
Lodgepole pine	3	2	5	5	15
Engelmann spruce	6	2	5	5	10
red fir, subalpine fir	7	2	5	5	15
ponderosa pine	4	2	5	5	10
other	4	2	5	5	15
California					
western white pine	4	3	10	15	15
sugar pine	3	3	10	15	15
Douglas-fir	5	3	10	15	15
white fir, grand fir	7	3	10	15	15
Mountain hemlock	4	3	10	15	15
incense-cedar	5	1	10	15	20
Lodgepole pine	3	3	10	15	15
Engelmann spruce	6	3	10	10	10
red fir, subalpine fir	7	3	10	15	15
ponderosa pine	4	3	10	10	10
other	4	3	10	15	15

Table 4.33—Stand structure classification is converted from the Crookston and Stage to Ottmar system using these mappings and assumptions.

Stand classification system		
Crookston and Stage (1999)	Ottmar and others (1996)	Notes
0	1	Regenerating from bare ground
1	1	Stand initiation
2	2	Stem exclusion, open canopy: <60% canopy cover
2	3	Stem exclusion, closed canopy: >=60% canopy cover
3	4	Understory reinitiation
4	5	Young forest, single stratum
5	6	Old forest, single stratum
6	7	Old forest, multistrata

Table 4.34—Cover type and structural stage class are used to determine the appropriate FCC, in order to estimate herb and shrub load and the initial default down woody debris load. FCCs for sugar pine are mapped using western white pine. When a ponderosa pine stand is classed as regenerating from bare ground, it is assumed that it has been recently logged and is assigned FCC-1 instead of FCC-4.

Species	Structural stage [§]					
	1	2	3	4, 5	6	7
western white pine	52	53	56	58	57	61
sugar pine	52	53	56	58	57	61
Douglas-fir	52	53	56	58	62	62
white fir, grand fir	52	53	56	58	62	62
mountain hemlock	52	53	56	58	62	62
incense-cedar	52	53	56	58	62	62
lodgepole pine	103	106	107	110	112	113
Engelmann spruce	52	53	56	59	61	62
red fir, subalpine fir	52	53	56	59	62	62
ponderosa pine	4, 1	4	4	8	11	10
other	—	—	—	160	—	—

[§] 1 = stand initiation (si); 2 = stem exclusion, open canopy (cover <60%) (seoc); 3 = stem exclusion, closed canopy (canopy cover >60%) (secc); 4 = understory re-initiation (ur); 5 = young forest, multi-story (yfms); 6 = old forest single-story (ofss); 7 = old forest, multi-story (ofms).

Table 4.35—Default live fuel loads (tons/acre) are determined for each FCC. The appropriate FCC is assigned using table 4.34.

FCC	Herb	Shrub	FCC	Herb	Shrub
1	0.3	0.4	61	0.3	0.4
4	0.5	0.5	62	0.8	0.5
8	0.0	0.0	103	0.3	0.4
10	0.5	2.5	106	0.5	0.5
11	0.5	0.5	107	0.5	0.5
52	0.5	0.5	110	0.5	0.5
53	0.5	0.5	112	0.3	0.4
56	0.5	0.5	113	0.5	0.5
57	0.3	0.4	160	0.7	3.3
58	0.3	0.4			

Dead Fuels: Initial default values for the dead fuel components are determined using Fuel Characterization Classes (FCCs; Ottmar and others 1996) using tables 4.33 and 4.34 and following the process just described in the section on live herbs and shrubs. The FCC diameter breakpoints shown in table 4.36 are different from those used by the FFE. Linear interpolation is used to partition the FCC fuel loads into the FFE size classes. The SO-FFE initial loads for litter are set to zero, since these data are absent from the FCC system. Default initial fuel loads can be modified using the **FUELINIT** keyword.

Table 4.36—Default dead fuel loads (tons/acre) are determined for each FCC used in the SO-FFE variant. The appropriate FCC for each modeled stand is assigned using tables 4.33 and 4.34. Litter estimates are absent in the FCC, and set to zero.

FCC	Size class (inches)						Litter	Duff
	< 0.25	0.25 – 1	1 – 3	3 – 9	9 – 20	> 20		
1	0.5	0.8	1.7	1.9	3.0	0.0	–	2.3
4	0.1	1.5	2.2	1.1	1.8	3.3	–	6.0
8	0.1	1.6	4.2	2.1	2.9	4.7	–	9.8
10	0.2	1.2	2.3	2.3	2.4	2.0	–	12.8
11	0.0	1.5	4.9	10.1	6.2	4.0	–	12.8
52	0.6	2.3	1.9	2.0	0.0	0.0	–	2.3
53	0.5	1.3	3.0	4.5	1.5	0.0	–	2.3
56	0.5	1.3	3.0	4.5	1.5	0.0	–	9.1
57	0.4	0.6	1.1	8.8	7.2	5.0	–	9.1
58	0.7	1.1	1.5	3.1	4.7	0.0	–	15.9
61	0.5	1.2	1.2	2.5	5.2	2.0	–	20.4
62	0.5	2.6	4.3	7.0	10.5	3.0	–	20.4
103	0.5	0.8	1.7	0.9	0.0	0.0	–	2.3
106	0.3	0.7	4.0	0.8	0.0	0.0	–	3.8
107	0.4	1.2	7.4	2.1	0.0	0.0	–	3.8
110	0.7	2.3	5.9	5.1	2.0	0.0	–	4.5
112	0.2	0.9	1.7	1.3	3.0	0.0	–	6.0
113	0.2	1.1	3.4	14.8	3.5	0.0	–	6.0
160	0.2	0.4	0.8	0.0	0.0	0.0	–	2.3

4.4.4 Bark Thickness

Bark thickness contributes to predicted tree mortality from simulated fires. The bark thickness multipliers in table 4.37 are used to calculate single bark thickness as described in the “Model Description” chapter, section 2.5.5. The bark thickness equation used in the mortality equation is unrelated to the bark thickness used in the base FVS model. Data are from FOFEM 5.0 (Reinhardt and others 2001).

Table 4.37—Species specific constants for determining single bark thickness.

Species	Multiplier (V_{sp})
western white pine	0.035
sugar pine	0.072
Douglas-fir	0.063
white fir, grand fir	0.048
mountain hemlock	0.040
incense-cedar	0.060
lodgepole pine	0.028
Engelmann spruce	0.036
red fir, subalpine fir	0.039
ponderosa pine	0.063
other	0.025

4.4.5 Decay Rate

Decay of down material is simulated by applying the loss rates shown in table 4.38, as described in section 2.4.5 of the “Model Description” chapter. Default decay rates are based on Abbott and Crossley (1982). Decay parameters were originally developed at the SO-FFE workshop. Parameters for California stands were revised at a California variants workshop (Stephanie Reban, pers.comm, February 2003),

By default, the FFE decays all wood species at the rates shown in table 4.39. The decay rates of species groups may be modified by users, who can

Table 4.38—Default annual loss rates are applied based on size class.

Size class	Annual loss rate	Proportion of loss becoming duff
Oregon		
0 — 0.25 in.	0.12	
0.25 — 1.0 in.		
1.0 — 3.0 in.	0.09	
3.0 — 6.0 in.		0.02
6.0 — 12.0 in.	0.015	
> 12.0 in.		
Litter	0.5	
Duff	0.002	0.0
California		
0 — 0.25 in.		
0.25 — 1.0 in.	0.025	
1.0 — 3.0 in.		
3.0 — 6.0 in.		0.02
6.0 — 12.0 in.	0.0125	
> 12.0 in.		
Litter	0.5	
Duff	0.002	0.0

Table 4.39—Default wood decay classes used in the WS-FFE variant. Classes are from *The Wood Handbook* (1999). (1 = exceptionally high; 2 = resistant or very resistant; 3 = moderately resistant, and 4 = slightly or nonresistant.)

Species	Decay class
western white pine	4
sugar pine	4
Douglas-fir	3
white fir, grand fir	4
mountain hemlock	4
incense-cedar	2
lodgepole pine	4
Engelmann spruce	4
red fir, subalpine fir	4
ponderosa pine	4
other	2

provide rates to the four decay classes shown in table 4.39 using the **FUELDCA** keyword. Users can also reassign species to different classes using the **FUELPOOL** keyword.

4.4.6 Moisture Content

Moisture content of the live and dead fuels is used to calculate fire intensity and fuel consumption (“Model Description” chapter, section 2.5.2). Users can choose from four predefined moisture groups shown in table 4.40, or they can specify moisture conditions for each class using the **MOISTURE** keyword. The predefined moisture groups are the same as those defined for the NI-FFE.

4.4.7 Fire Behavior Fuel Models

Fire behavior fuel models (Anderson 1982) are used to estimate flame length and fire effects stemming from flame length. Fuel models are determined using fuel load and stand attributes (“Model Description” chapter, section 2.4.8) specific to each FFE variant. In addition, stand management actions such as thinning and harvesting can abruptly increase fuel loads and

Table 4.40—Moisture values, which alter fire intensity and consumption, have been predefined for four groups.

Size class	Moisture group			
	Very dry	Dry	Moist	Wet
0 – 0.25 in. (1 hr.)	3	8	12	12
0.25 – 1.0 in. (10 hr.)	4	8	12	12
1.0 – 3.0 in. (100 hr.)	5	10	14	14
> 3.0 in. (1000+ hr.)	10	15	25	25
Duff	15	50	125	125
Live	70	110	150	150

can trigger “Activity Fuels” conditions, resulting in the selection of alternative fuel models. At their discretion, FFE users have the option of:

1. Defining and using their own fuel models
2. Defining the choice of fuel models and weights
3. Allowing the FFE variant to determine a weighted set of fuel models
4. Allowing the FFE variant to determine a weighted set of fuel models, then using the dominant model

This section explains the steps taken by the SO-FFE to follow the third and fourth of these four options.

When the combination of large and small fuel lies in the lower left corner of the graph shown in figure 4.3, one or more low-fuel fuel models become candidate models. In other regions of the graph, other fuel models may also be candidates. The logical flow shown in figure 4.4 defines which low-fuel model(s) will become candidates. According to the logic of figure 4.4, only a single fuel model will be chosen for a given stand structure. Consequently, as a stand undergoes structural changes due to management or maturation, the selected fire model can jump from one model selection to another, which in turn may cause abrupt changes in predicted fire behavior. To smooth out changes resulting from changes in fuel model, the strict logic is augmented by linear transitions between states that involve continuous variables (for example, percent canopy cover, average height, snag density, and so forth). In addition, a fuzzy logic approach is used to incorporate weights based on the dominant cover type.

If the **STATFUEL** keyword is selected, fuel model is determined by using only the closest-match fuel model identified by either figure 4.3 or figure 4.4. The **FLAMEADJ** keyword allows the user to scale the calculated flame length or override the calculated flame length with a value they choose.

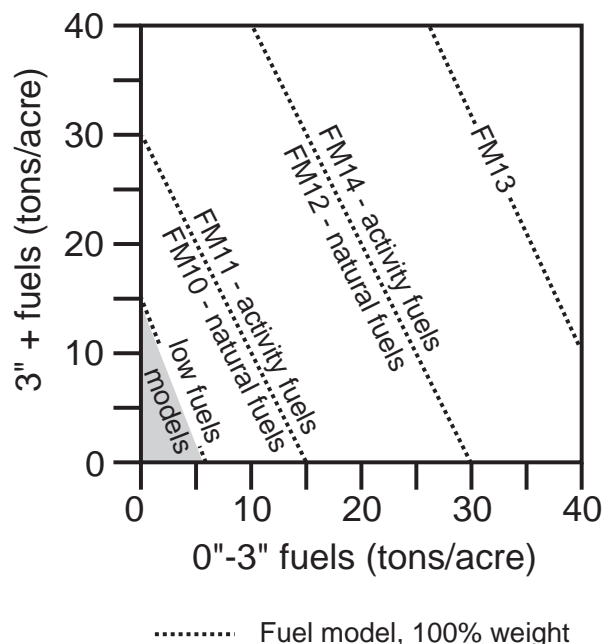
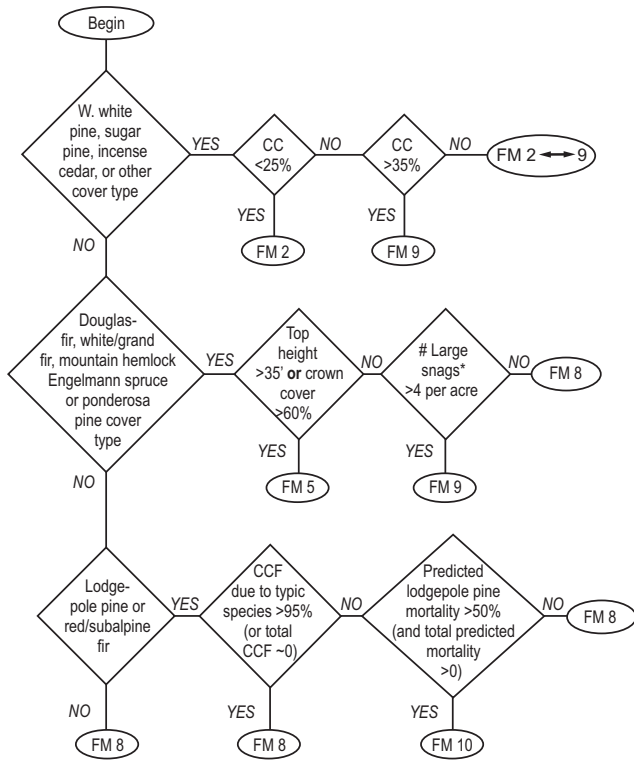
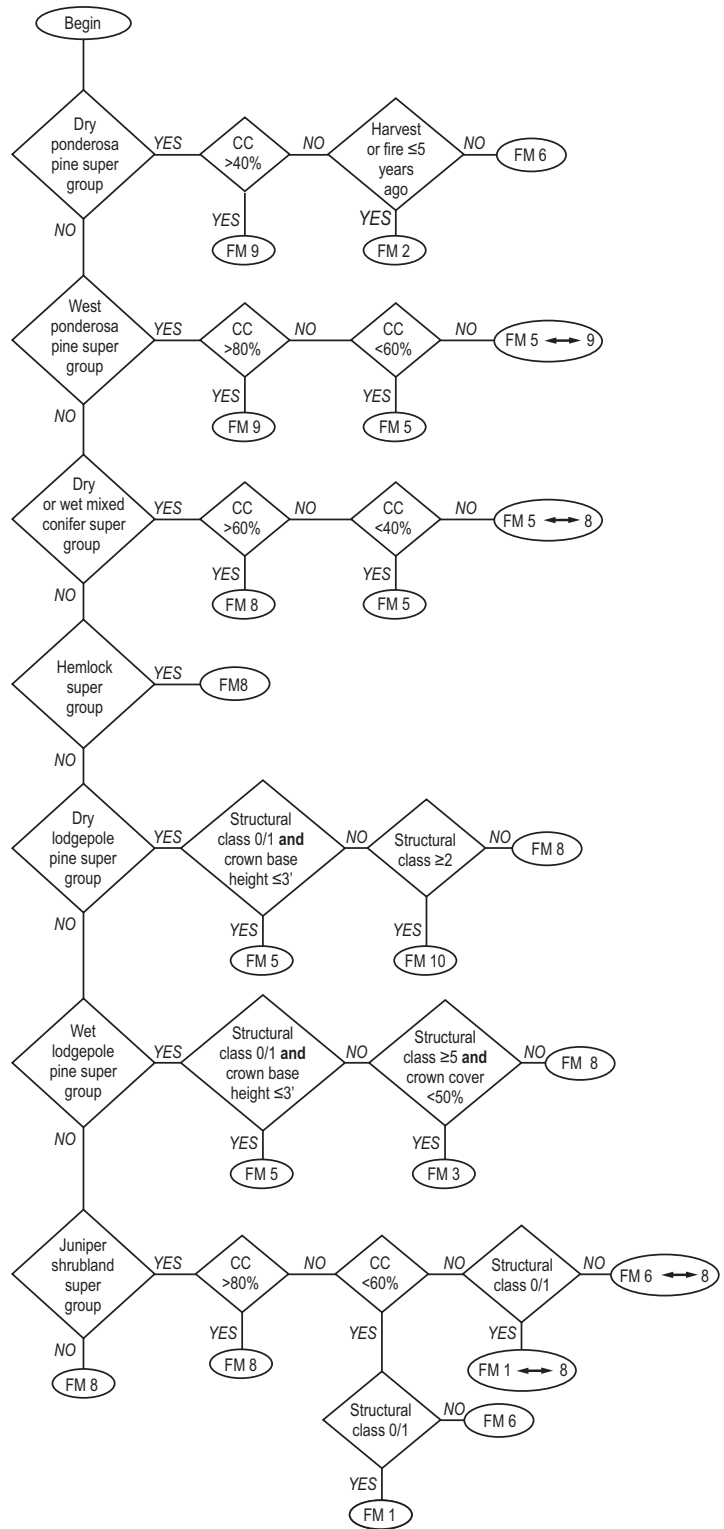

Figure 4.3—If large and small fuels map to the shaded area, candidate fuel models are determined using the logic shown in figure 4.4. Otherwise, flame length is based on the distance to the closest fuel models, identified by the dashed lines, and on recent management (see “Model Description” chapter, section 2.4.8 for further details).

A**Private Lands and Region 5 National Forests**

*-> QMD of live trees

B**Region 6 National Forests****Figure 4.4**—Logic for modeling fire at "low" fuel loads in USDA Forest Service Region 5 (a) and Region 6 (b) forests in the SO-FFE.

4.4.8 Consumption

Consumption of natural fuels is modeled in the same way as in the NI-FFE (“Model Description” chapter, section 2.5.5). Activity fuels, material created from a stand entry in the previous 5 years, are modeled using equations from Consume 1.0 (Ottmar and other 1993) with some modifications based on new information.

1-hour and 10-hour fuels

100 percent consumption.

100-hour fuels

$$C = 0.9 - 0.0535 \left[M_{10} - 0.03 \left(\frac{\ln(0.5F \left(1 + \frac{\text{Slope}20}{60} + \frac{\text{Wind}}{4} \right))}{\ln(2)} \right) - 12 \right]$$

where:

- C is the percent consumption
- F is the amount of 100-hour fuel present before the burn, in tons per acre
- M_{10} is the percent fuel moisture of the 10-hour fuels
- Slope is the site slope, in percent
- Wind is the wind speed at the time of the fire, in mph.

1000-hour+ fuels

The consumption of larger fuels depends on their moisture as well as the moisture level of the 10-hour fuels, 1000-hour fuels, and the amount of consumption of the 100-hour fuels.

First, a diameter reduction variable (DRED) is calculated based on fuel moisture (M), as shown in table 4.41. Then, if the 10-hour fuel moisture is less than 15 percent, the DRED value is further modified using table 4.42.

Finally, the percent consumption can be calculated as:

$$C = 1 - \left(\frac{a - DRED}{5.2} \right)^2$$

where:

- C is the percent consumption
- $DRED$ is the diameter reduction factor calculated above, and
- a is 5.2 for 1000-hour fuels, and 13.7 for 10000-hour fuels

Duff—The consumption of duff depends on the moisture level of the duff and consumption in some of the other fuel classes (table 4.43). Assumptions were made about the duff moisture values at which each of the equations was

Table 4.41—The relationship between diameter reduction (DRED) and 1000-hour moisture.

Condition	Equation
$M > 60\%$	1: $DRED = -0.005 \times M + 0.731$
$M > 44\%$ and $M \leq 60\%$	2: $DRED = -0.0178 \times M + 1.489$
$M \geq 44\%$ and Consumption of 100hr $\leq 75\%$	3: $DRED = -0.096 \times M + 4.6495$
$M < 44\%$ and Consumption of 100hr $\geq 85\%$	4: $DRED = -0.125 \times M + 6.27$
$M < 44\%$ and Consumption of 100hr $75\% - 85\%$	Interpolate between eq. 3 and 4

used, the quadratic mean diameter of the 100-hour fuels, the number of dry months prior to the fire, and the bulk density.

where:

C_i is the consumption value of the i -th hour fuels.

$DRED$ is the diameter reduction factor of the large fuels, as calculated above.

R is the reduction factor of the duff.

Consumption, in tons per acre rather than percent, is then calculated as:

$$C = 12.1 \times R \times b$$

where:

C is the maximum tons per acre of duff consumed

R is calculated above, and

b is a multiplier which is:
 0.50 – when duff depth is less than 1 inch;
 0.75 – when duff depth is 2 or more inches, and
 is interpolated when duff depth is 1 to 2 inches.

Table 4.42—The relationship between diameter reduction (DRED) and 1000-hour moisture, given low 10-hour moisture.

1000-hr fuel moisture	Equation
$M_{10} \geq 40\%$	$DRED = DRED \times (1 - 0.22)$
$M_{10} 40\%-50\%$	$DRED = DRED \times (1 - 0.11)$

Table 4.43—Consumption equations for a range of duff moisture levels.

Duff moisture	Equation
$\geq 200\%$	$R = 0.537 + (C_{1000} + C_{10000})$
125% – 200%	$R = 0.323 + 1.034 + \sqrt{DRED}$
50% – 125%	$R = 1.323 + 1.034 + \sqrt{DRED}$
< 50%	$R = 2.323 + 1.034 + \sqrt{DRED}$

4.5 Central Rockies (CR)

4.5.1 Tree Species

The Central Rockies variant models the 22 tree species shown in table 4.44. Two additional categories, “other softwood” and “other hardwood” are modeled using pines and cottonwoods, respectively.

4.5.2 Snags

The majority of the snag model logic is based on unpublished data provided by Bruce Marcot (USFS, Portland, OR, unpublished data 1995). Snag fall parameters were developed at the FFE design workshop. A complete description of the Snag Submodel is provided in section 2.3 of the FFE “Model Description” chapter.

Four variables are used to modify the Snag Submodel for the different species in the CR-FFE variant:

- A multiplier to modify the species’ fall rate
- A multiplier to modify the time required for snags to decay from a “hard” to “soft” state
- The maximum number of years that snags will remain standing
- A multiplier to modify the species’ height loss rate

These variables are summarized in tables 4.45 and 4.46.

Height loss rate of quaking aspen and cottonwoods are insignificant in comparison to their rapid snag fall rate and are not modeled. The fall rate of these hardwoods is also halved in the 10 years following a burn. In the case

Table 4.44—Tree species simulated by the Central Rockies variant.

Common name	Scientific name	Notes
subalpine fir	<i>Abies lasiocarpa</i>	
corkbark fir	<i>Abies lasiocarpa arizonica</i>	
Douglas-fir	<i>Pseudotsuga menziesii</i>	
grand fir	<i>Abies grandis</i>	
white fir	<i>Abies concolor</i>	
mountain hemlock	<i>Tsuga mertensiana</i>	
western redcedar	<i>Thuja plicata</i>	
western larch	<i>Larix occidentalis</i>	
bristlecone pine	<i>Pinus aristata</i>	
limber pine	<i>Pinus flexilis</i>	
lodgepole pine	<i>Pinus contorta</i>	
pinyon pine	<i>Pinus edulis</i>	
ponderosa pine	<i>Pinus ponderosa</i>	
whitebark pine	<i>Pinus albicaulis</i>	
southwestern white pine	<i>Pinus strobiformis</i>	
Rocky Mountain juniper	<i>Juniperus scopulorum</i>	
blue spruce	<i>Picea pungens</i>	
Engelmann spruce	<i>Picea engelmannii</i>	
white spruce	<i>Picea glauca</i>	
quaking aspen	<i>Populus tremuloides</i>	
cottonwoods	<i>Populus spp.</i>	
oaks	<i>Quercus spp.</i>	
other softwoods		= pines
other hardwoods		= cottonwoods

Table 4.45—Default snag fall, snag height loss and soft-snag characteristics for 20 inch DBH snags in the CR-FFE

Species	95% fallen	All down	50% height	Hard-to-soft
	-----Year s-----			
subalpine fir	12	40	20	35
corkbark fir	12	40	20	35
Douglas-fir	97 [§]	100	33	42
grand fir	12	40	20	35
white fir	12	40	20	35
mountain hemlock	31	150	310	39
western redcedar	28	90	33	35
western larch	34	150	310	42
bristlecone pine	—	—	660	35
limber pine	31	150	310	35
lodgepole pine	31	150	660	35
pinyon pine	31	150	310	35
ponderosa pine	31	150	310	39
whitebark pine	31	150	310	35
southwestern white pine	31	150	310	39
Rocky Mountain juniper	31	150	310	35
blue spruce	97 [§]	100	660	35
Engelmann spruce	97 [§]	100	660	35
white spruce	97 [§]	100	660	35
quaking aspen	8	5	—	35
cottonwoods	8	5	—	35
oaks	12	40	20	35
other softwoods	31	150	660	35
other hardwoods	8	5	—	35

[§]This value results from using 32% of the default rate for Douglas-fir and spruce snags >18" DBH, as described in the text.

of Douglas-fir and spruce snags greater than 18 inches DBH, the fall rate is reduced to 32 percent of the rate predicted by Marcot's equation.

Snag bole volume is determined in using the base FVS model equations. The coefficients shown in table 4.47 are used to convert volume to biomass. Soft snags have 80 percent the density of hard snags.

Snag dynamics can be modified by the user using the **SNAGBRK**, **SNAGFALL**, **SNAGDCAY** and **SNAGPBN** keywords described in the model description.

4.5.3 Fuels

Information on live fuels was developed using FOFEM 4.0 (Reinhardt and others 1997) and FOFEM 5.0 (Reinhardt and others 2001) and in cooperation with Jim Brown (USFS, Missoula, MT pers. comm. 1995). A complete description of the Fuel Submodel is provided in section 2.4 of the FFE "Model Description" chapter.

Fuels are divided into to four categories: live tree bole, live tree crown, live herb and shrub, and down woody debris (DWD). Live herb and shrub fuel load, and initial DWD are assigned based on the cover species with greatest basal area. If there is no basal area in the first simulation cycle (a "bare ground" stand) then the initial fuel loads are assigned by the vegetation code provided with the **STDINFO** keyword. If the vegetation code is missing or does not identify an overstory species, the model uses a lodgepole pine cover

Table 4.46—Default snag fall, snag height loss and soft-snag multipliers for the CR-FFE. These parameters result in the values shown in table 4.45. (These three columns are the default values used by the SNAGFALL, SNAGBRK, and SNAGDCAY keywords, respectively.)

Species	Snag fall	Height loss	Hard-to-soft
subalpine fir	2.5	1.494	0.9
corkbark fir	2.5	1.494	0.9
Douglas-fir	1.0 [§]	0.9	1.1
grand fir	2.5	1.494	0.9
white fir	2.5	1.494	0.9
mountain hemlock	1.0	0.098	1.0
western redcedar	1.1	0.9	0.9
western larch	0.9	0.098	1.1
bristlecone pine	—	0.046	0.9
limber pine	1.0	0.098	0.9
lodgepole pine	1.0	0.046	0.9
pinyon pine	1.0	0.098	0.9
ponderosa pine	1.0	0.098	1.0
whitebark pine	1.0	0.098	0.9
southwestern white pine	1.0	0.098	1.0
Rocky Mountain juniper	1.0	0.098	0.9
blue spruce	1.0 [§]	0.046	0.9
Engelmann spruce	1.0 [§]	0.046	0.9
white spruce	1.0 [§]	0.046	0.9
quaking aspen	4.0	—	0.9
cottonwoods	4.0	—	0.9
oaks	2.5	1.494	0.9
other softwoods	1.0	0.046	0.9
other hardwoods	4.0	—	0.9

[§]This value applies to Douglas-fir and spruce snags <18" DBH; see text for details.

type to assign the default fuels. If there is no basal area in other cycles of the simulation (after a simulated clearcut, for example) herb and shrub fuel biomass is assigned by the previous cover type.

Live Tree Bole: The fuel contribution of live trees is divided into two components: bole and crown. Bole volume is transferred to the FFE after being computed by the FVS model, then converted to biomass using oven-dry wood density calculated from table 4-3a and equation 3-5 of *The Wood Handbook* (Forest Products Laboratory 1999). The coefficient in table 4.47 for Douglas-fir is based on 'Douglas-fir south'.

Live Tree Crown: As described in the section 2 of the FFE "Model Description" chapter, equations in Brown and Johnston (1976) provide estimates of live and dead crown material for most species in the CR-FFE (table 4.48). Mountain hemlock biomass is based on Gholz (1979), using western hemlock equations from Brown and Johnston to partition the biomass and also to provide estimates for trees less than 1 inch diameter. Pinyon pine, juniper, and Gambel oak may have single or multiple stem forms: single stem equations were used to compute biomass in all cases

Table 4.47—Wood density (ovendry lb/ft³)
used in the CR-FFE variant

Species	Density (lb/ft ³)
subalpine fir	21.1
corkbark fir	21.1
Douglas-fir	30.3
grand fir	24.1
white fir	25.6
mountain hemlock	29.5
western redcedar	21.1
western larch	34.3
bristlecone pine	26.4
limber pine	24.8
lodgepole pine	26.4
pinyon pine	31.8
ponderosa pine	26.4
whitebark pine	24.8
southwestern white pine	24.8
Rocky Mountain juniper	34.9
blue spruce	25.6
Engelmann spruce	22.6
white spruce	25.6
quaking aspen	24.1
cottonwoods	21.1
oaks	39.6
other softwoods	26.4
other hardwoods	21.1

Table 4.48—The crown biomass equations listed here determine the biomass of foliage, branch and stem wood. Species mappings are done for species for which equations are not available.

Species	Species mapping and equation source
subalpine fir	Brown and Johnston (1976)
corkbark fir	subalpine fir: Brown and Johnston (1976)
Douglas-fir	Brown and Johnston (1976)
grand fir	Brown and Johnston (1976)
white fir	Grand fir: Brown and Johnston (1976)
mountain hemlock	Gholz (1979); Brown and Johnston (1976)
western redcedar	Brown and Johnston (1976)
western larch	Brown and Johnston (1976)
bristlecone pine	pinyon pine: Chojnacky (1992), Grier and others (1992)
limber pine	lodgepole pine: Brown and Johnston (1976)
lodgepole pine	Brown and Johnston (1976)
pinyon pine	Chojnacky (1992), Grier and others (1992)
ponderosa pine	Brown and Johnston (1976)
whitebark pine	Brown (1978)
southwestern white pine	western white pine: Brown and Johnston (1976)
Rocky Mountain juniper	Chojnacky (1992), Grier and others (1992)
blue spruce	Engelmann spruce: Brown and Johnston (1976)
Engelmann spruce	Brown and Johnston (1976)
white spruce	Engelmann spruce: Brown and Johnston (1976)
quaking aspen	Ruark (1987) <1" DBH, Standish and others (1985) >1" DBH
cottonwoods	quaking aspen: Ruark (1987) <1" DBH, Standish and others (1985) >1" DBH
oaks	Chojnacky (1992)
other softwoods	lodgepole pine: Brown and Johnston (1976)
other hardwoods	quaking aspen: Ruark (1987) <1" DBH, Standish and others (1985) >1" DBH

within the FFE. The FVS base model computes volume of these three species based on firewood utilization with a minimum branch of diameter of 1.5 inches. Crown and bole dynamics compatibility was maintained by defining tree crown as being made up of branches and twigs (including dead material) less than 1.5 inches, and foliage.

Live leaf lifespan is used to simulate the contribution of needles and leaves to annual litter fall. Dead foliage and branch materials also contribute to litter fall, at the rates shown in table 4.49. Each year the inverse of the lifespan is added to the litter pool from each biomass category. Leaf lifespan data are from Keane and others (1989).

Live Herbs and Shrubs: Live herb and shrub fuels are modeled simply by the FFE. Shrubs and herbs are assigned a biomass value based on total tree canopy cover and dominant overstory species (table 4.50). When there are no trees, habitat type is used to infer the most likely dominant species of the previous stand (“Model Description” chapter, section 2.4.2). When total tree canopy cover is less than 10 percent, herb and shrub biomass is assigned an “initiating” value (the ‘I’ rows from table 4.50). When canopy cover is greater than 60 percent, biomass is assigned an “established” value (the ‘E’ rows). Live fuel loads are linearly interpolated when canopy cover is between 10 and 60 percent. Data are taken from FOFEM 4.0 (Reinhardt and others 1997) with modifications provided by Jim Brown (USFS, Missoula, MT pers. comm., 1995). Data on pinyon pine, Rocky Mountain juniper, quaking aspen, and oaks were developed after examining live fuels reported in the Stereo Photo Guides for Quantifying Natural Fuels (Ottmar and others 2000a, Ottmar and others 2000b).

Table 4.49—Life span of live and dead foliage (years) and dead branches for species modeled in the CR-FFE variant.

Species	Live	Dead			
	Foliage	Foliage	<0.25”	0.25–1”	>1”
subalpine fir	7	2	10	15	15
corkbark fir	7	2	10	15	15
Douglas-fir	5	2	10	15	15
grand fir	7	2	10	15	15
white fir	7	2	10	15	15
mountain hemlock	4	2	10	10	10
western redcedar	5	2	10	15	20
western larch	1	1	10	15	15
bristlecone pine	3	2	10	15	20
limber pine	3	2	10	15	15
lodgepole pine	3	2	10	15	15
pinyon pine	3	2	10	15	15
ponderosa pine	4	2	10	10	10
whitebark pine	3	2	10	15	15
southwestern white pine	4	2	10	10	10
Rocky Mountain juniper	4	2	10	15	20
blue spruce	6	2	10	10	10
Engelmann spruce	6	2	10	10	10
white spruce	6	2	10	10	10
quaking aspen	1	1	10	10	10
cottonwoods	1	1	10	10	10
oaks	1	1	10	15	15
other softwoods	3	2	10	15	15
other hardwoods	1	1	10	10	10

Table 4.50—Values (dry weight, tons/acre) for live fuels used in the CR-FFE. Biomass is linearly interpolated between the “initiating” (I) and “established” (E) values when canopy cover is between 10 and 60 percent.

Species		Herbs	Shrubs	Comments
subalpine fir	E	0.15	0.20	
	I	0.30	2.00	
corkbark fir	E	0.15	0.20	Use subalpine fir
	I	0.30	2.00	
Douglas-fir	E	0.20	0.20	
	I	0.40	2.00	
grand fir	E	0.15	0.10	
	I	0.30	2.00	
white fir	E	0.15	0.10	Use subalpine fir
	I	0.30	2.00	
mountain hemlock	E	0.15	0.20	
	I	0.30	2.00	
western redcedar	E	0.20	0.20	
	I	0.40	2.00	
western larch	E	0.20	0.20	
	I	0.40	2.00	
bristlecone pine	E	0.04	0.05	Use pinyon pine
	I	0.13	1.63	
limber pine	E	0.20	0.10	Use lodgepole pine
	I	0.40	1.00	
lodgepole pine	E	0.20	0.10	
	I	0.40	1.00	
pinyon pine	E	0.04	0.05	Ottmar and others (2000a)
	I	0.13	1.63	
ponderosa pine	E	0.20	0.25	
	I	0.25	0.10	
whitebark pine	E	0.20	0.10	Use lodgepole pine
	I	0.40	1.00	
southwestern white pine	E	0.15	0.10	Use western white pine
	I	0.30	2.00	
Rocky Mountain juniper	E	0.04	0.05	Ottmar and others (2000a)
	I	0.13	1.63	
blue spruce	E	0.15	0.20	Use Engelmann spruce
	I	0.30	2.00	
Engelmann spruce	E	0.15	0.20	
	I	0.30	2.00	
white spruce	E	0.15	0.20	Use Engelmann spruce
	I	0.30	2.00	
quaking aspen	E	0.25	0.25	Ottmar and others (2000a)
	I	0.18	1.32	
cottonwoods	E	0.25	0.25	Ottmar and others (2000a)
	I	0.18	1.32	
oaks	E	0.23	0.22	Use quaking aspen
	I	0.55	0.35	
other softwoods	E	0.20	0.10	Use lodgepole pine
	I	0.40	1.00	
other hardwoods	E	0.25	0.25	Use quaking aspen
	I	0.18	1.32	

Dead Fuels: Initial default DWD pools are based on overstory species. When there are no trees, habitat type is used to infer the most likely dominant species of the previous stand (“Model Description” chapter, section 2.4.2). Default fuel loadings were provided by Jim Brown (USFS, Missoula, MT pers. comm., 1995) (table 4.51). If tree canopy cover is less than 10

Table 4.51—Canopy cover and cover type are used to assign default dead fuel loads (tons/acre) by size class for established (E) and initiating (I) stands.

Species		Size class (inches)						Litter	Duff
		< 0.25	0.25 – 1	1 – 3	3 – 6	6 – 12	> 12		
subalpine fir	E	1.1	1.1	2.2	10.0	10.0	0.0	0.6	30.0
	I	0.7	0.7	1.6	4.0	4.0	0.0	0.3	12.0
corkbark fir	E	1.1	1.1	2.2	10.0	10.0	0.0	0.6	30.0
	I	0.7	0.7	1.6	4.0	4.0	0.0	0.3	12.0
Douglas-fir	E	0.9	0.9	1.6	3.5	3.5	0.0	0.6	10.0
	I	0.5	0.5	1.0	1.4	1.4	0.0	0.3	5.0
grand fir	E	0.7	0.7	3.0	7.0	7.0	0.0	0.6	25.0
	I	0.5	0.5	2.0	2.8	2.8	0.0	0.3	12.0
white fir	E	0.7	0.7	3.0	7.0	7.0	0.0	0.6	25.0
	I	0.5	0.5	2.0	2.8	2.8	0.0	0.3	12.0
mountain hemlock	E	1.1	1.1	2.2	10.0	10.0	0.0	0.6	30.0
	I	0.7	0.7	1.6	4.0	4.0	0.0	0.3	12.0
western redcedar	E	1.6	1.6	5.2	15.0	20.0	15.0	1.0	35.0
	I	1.6	1.6	3.6	6.0	8.0	6.0	0.5	12.0
western larch	E	0.9	0.9	1.6	3.5	3.5	0.0	0.6	10.0
	I	0.5	0.5	1.0	1.4	1.4	0.0	0.3	5.0
bristlecone pine	E	0.2	0.8	2.3	1.4	3.0	0.0	9.3	0.0
	I	0.0	0.1	0.0	0.0	0.0	0.0	2.0	0.0
limber pine	E	0.9	0.9	1.2	7.0	8.0	0.0	0.6	15.0
	I	0.6	0.7	0.8	2.8	3.2	0.0	0.3	7.0
lodgepole pine	E	0.9	0.9	1.2	7.0	8.0	0.0	0.6	15.0
	I	0.6	0.7	0.8	2.8	3.2	0.0	0.3	7.0
pinyon pine	E	0.2	0.8	2.3	1.4	3.0	0.0	9.3	0.0
	I	0.0	0.1	0.0	0.0	0.0	0.0	2.0	0.0
ponderosa pine	E	0.7	0.7	1.6	2.5	2.5	0.0	1.4	5.0
	I	0.1	0.1	0.2	0.5	0.5	0.0	0.5	0.8
whitebark pine	E	0.9	0.9	1.2	7.0	8.0	0.0	0.6	15.0
	I	0.6	0.7	0.8	2.8	3.2	0.0	0.3	7.0
southwestern white pine	E	1.0	1.0	1.6	10.0	10.0	10.0	0.8	30.0
	I	0.6	0.6	0.8	6.0	6.0	6.0	0.4	12.0
Rocky Mountain juniper	E	0.2	0.8	2.3	1.4	3.0	0.0	9.3	0.0
	I	0.0	0.1	0.0	0.0	0.0	0.0	2.0	0.0
blue spruce	E	1.1	1.1	2.2	10.0	10.0	0.0	0.6	30.0
	I	0.7	0.7	1.6	4.0	4.0	0.0	0.3	12.0
Engelmann spruce	E	1.1	1.1	2.2	10.0	10.0	0.0	0.6	30.0
	I	0.7	0.7	1.6	4.0	4.0	0.0	0.3	12.0
white spruce	E	1.1	1.1	2.2	10.0	10.0	0.0	0.6	30.0
	I	0.7	0.7	1.6	4.0	4.0	0.0	0.3	12.0
quaking aspen	E	0.2	0.6	2.4	3.6	5.6	0.0	1.4	16.8
	I	0.1	0.4	5.0	2.2	2.3	0.0	0.8	5.6
cottonwoods	E	0.2	0.6	2.4	3.6	5.6	0.0	1.4	16.8
	I	0.1	0.4	5.0	2.2	2.3	0.0	0.8	5.6
oaks	E	0.3	0.7	1.4	0.2	0.1	0.0	3.9	0.0
	I	0.1	0.1	0.0	0.0	0.0	0.0	2.9	0.0
other softwoods	E	0.9	0.9	1.2	7.0	8.0	0.0	0.6	15.0
	I	0.6	0.7	0.8	2.8	3.2	0.0	0.3	7.0
other hardwoods	E	0.2	0.6	2.4	3.6	5.6	0.0	1.4	16.8
	I	0.1	0.4	5.0	2.2	2.3	0.0	0.8	5.6

percent, the DWD pools are assigned an “initiating” value, and if cover is greater than 60 percent they are assigned the “established” value. Fuels are linearly interpolated when canopy cover is between 10 and 60 percent. Initial fuel loads can be modified using the **FUELINIT** keyword.

4.5.4 Bark Thickness

Bark thickness contributes to predicted tree mortality from simulated fires. The bark thickness multipliers in table 4.52 are used to calculate single bark thickness (“Model Description” chapter, section 2.5.5). The bark thickness equation used in the mortality equation is unrelated to the bark thickness used in the base FVS model. Data are from FOFEM 5.0 (Reinhardt and others 2001). The pinyon pine coefficient is based on *Pinus sp.* And corkbark fir is based on subalpine fir, both from FOFEM.

4.5.5 Decay Rate

Decay of down material is simulated by applying loss rates to biomass in categories based on the original size-class of the branch and bole pieces as described in section 2.4.5 of the “Model Description” chapter (table 4.53). Workshop participants noted that material decays slower in the area covered by the CR-FFE. This comment was supported by data in Brown and others (1998). Decay rate for woody material was therefore reduced 55 percent from the default decay rates based on Abbott and Crossley (1982). A portion of the

Table 4.52—Species specific constants for determining single bark thickness.

Species	Multiplier (V_{sp})
subalpine fir	0.041
corkbark fir	0.041
Douglas-fir	0.063
grand fir	0.046
white fir	0.048
mountain hemlock	0.040
western redcedar	0.035
western larch	0.063
bristlecone pine	0.030
limber pine	0.030
lodgepole pine	0.028
pinyon pine	0.030
ponderosa pine	0.063
whitebark pine	0.030
southwestern white pine	0.035
Rocky Mountain juniper	0.025
blue spruce	0.031
Engelmann spruce	0.036
white spruce	0.025
quaking aspen	0.044
cottonwoods	0.038
oaks	0.045
other softwoods	0.030
other hardwoods	0.038

Table 4.53—Default annual loss rates are applied based on size class. A portion of the loss is added to the duff pool each year. Loss rates are for hard material. The rates for woody material are 55 percent lower than the rates used in the NI-FFE variant. If present, soft material in all size classes except litter and duff decays 10 percent faster.

Size class (inches)	Annual loss rate	Proportion of loss becoming duff
< 0.25	0.054	
0.25 — 1		
1 — 3	0.041	
3 — 6		0.02
6 — 12	0.0068	
> 12		
Litter	0.50	
Duff	0.002	0.0

loss is added to the duff pool each year. Loss rates are for hard material; soft material in all size classes, except litter and duff, decays 10 percent faster.

By default, the FFE decays all wood species at the rates shown in table 4.53. The decay rates of species groups may be modified by users who can provide rates to the four decay classes shown in table 4.54 using the **FUELDCA** keyword. Users can also reassign species to different classes using the **FUELPOOL** keyword.

4.5.6 Moisture Content

Moisture content of the live and dead fuels is used to calculate fire intensity and fuel consumption (“Model Description” chapter, section 2.5.2). Users can choose from four predefined moisture groups (table 4.55) or they can specify moisture conditions for each class using the **MOISTURE** keyword.

4.5.7 Fire Behavior Fuel Models

Fire behavior fuel models (Anderson 1982) are used to estimate flame length and fire effects stemming from flame length. Fuel models are determined using fuel load and stand attributes (“Model Description” chapter, section 2.4.8) specific to each FFE variant. In addition, stand management actions such as thinning and harvesting can abruptly increase fuel loads and can trigger “Activity Fuels” conditions, resulting in the selection of alternative fuel models. At their discretion, FFE users have the option of:

1. Defining and using their own fuel models

Table 4.54—Default wood decay classes used in the CR-FFE variant. Classes are from *The Wood Handbook* (1999). (1 = exceptionally high; 2 = resistant or very resistant; 3 = moderately resistant, and 4 = slightly or nonresistant.)

Species	Decay class
subalpine fir	4
corkbark fir	4
Douglas-fir	3
grand fir	4
white fir	4
mountain hemlock	4
western redcedar	2
western larch	3
bristlecone pine	4
limber pine	4
lodgepole pine	4
pinyon pine	4
ponderosa pine	4
whitebark pine	4
southwestern white pine	4
Rocky Mountain juniper	2
blue spruce	4
Engelmann spruce	4
white spruce	4
quaking aspen	4
cottonwoods	4
oaks	2
other softwoods	4
other hardwoods	4

Table 4.55—Moisture values, which alter fire intensity and consumption, have been predefined for four groups. In general they are drier than the default values used in the NI-FFE.

Size class	Moisture group			
	Very dry	Dry	Moist	Wet
0 – 0.25 in. (1-hr)	4	5	8	10
0.25 – 1.0 in. (10-hr)	4	6	10	12
1.0 – 3.0 in. (100-hr)	5	8	12	15
> 3.0 in. (1000+ -hr)	10	15	16	18
Duff	15	50	125	200
Live	70	90	120	140

2. Defining the choice of fuel models and weights
3. Allowing the FFE variant to determine a weighted set of fuel models
4. Allowing the FFE variant to determine a weighted set of fuel models, then using the dominant model

This section explains the steps taken by the CR-FFE to follow the third and fourth of these four options

When the combination of large and small fuel lies in the lower left corner of the graph shown in figure 4.5, one or more low-fuel fuel models become candidate models. In other regions of the graph, other fuel models may also be candidates. The logical flow shown in figure 4.6 defines which low fuel model(s) will become candidates. According to the logic of figure 4.6, only a single fuel model will be chosen for a given stand structure. Consequently, as a stand undergoes structural changes due to management or maturation, the selected fire model can jump from one model selection to another, which in turn may cause abrupt changes in predicted fire behavior. To smooth out changes resulting from changes in fuel model, the strict logic is augmented by linear transitions between states that involve continuous variables (for example, percent canopy cover, average height, snag density, and so forth).

The program logic shown in figure 4.6 also uses stand structure classes in some decision rules. The CR-FFE uses the default structure class rules documented in Crookston and Stage (1999) unless model users alter those definitions using the **STRCLS** keyword.

If the **STATFUEL** keyword is selected, fuel model is determined by using only the closest match fuel model identified by either figure 4.5 or figure 4.6. The **FLAMEADJ** keyword allows the user to scale the calculated flame length or override the calculated flame length with a value they choose.

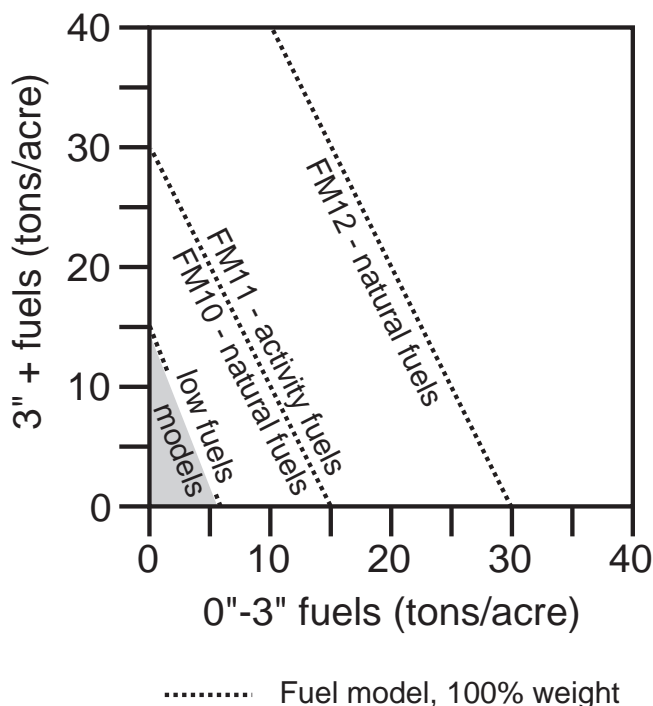

Figure 4.5—If large and small fuels map to the shaded area, candidate fuel models are determined using the logic shown in figure 4.6. Otherwise, flame length is based on the distance to the closest fuel models, identified by the dashed lines, and on recent management (see “Model Description” chapter, section 2.4.8 for further details).

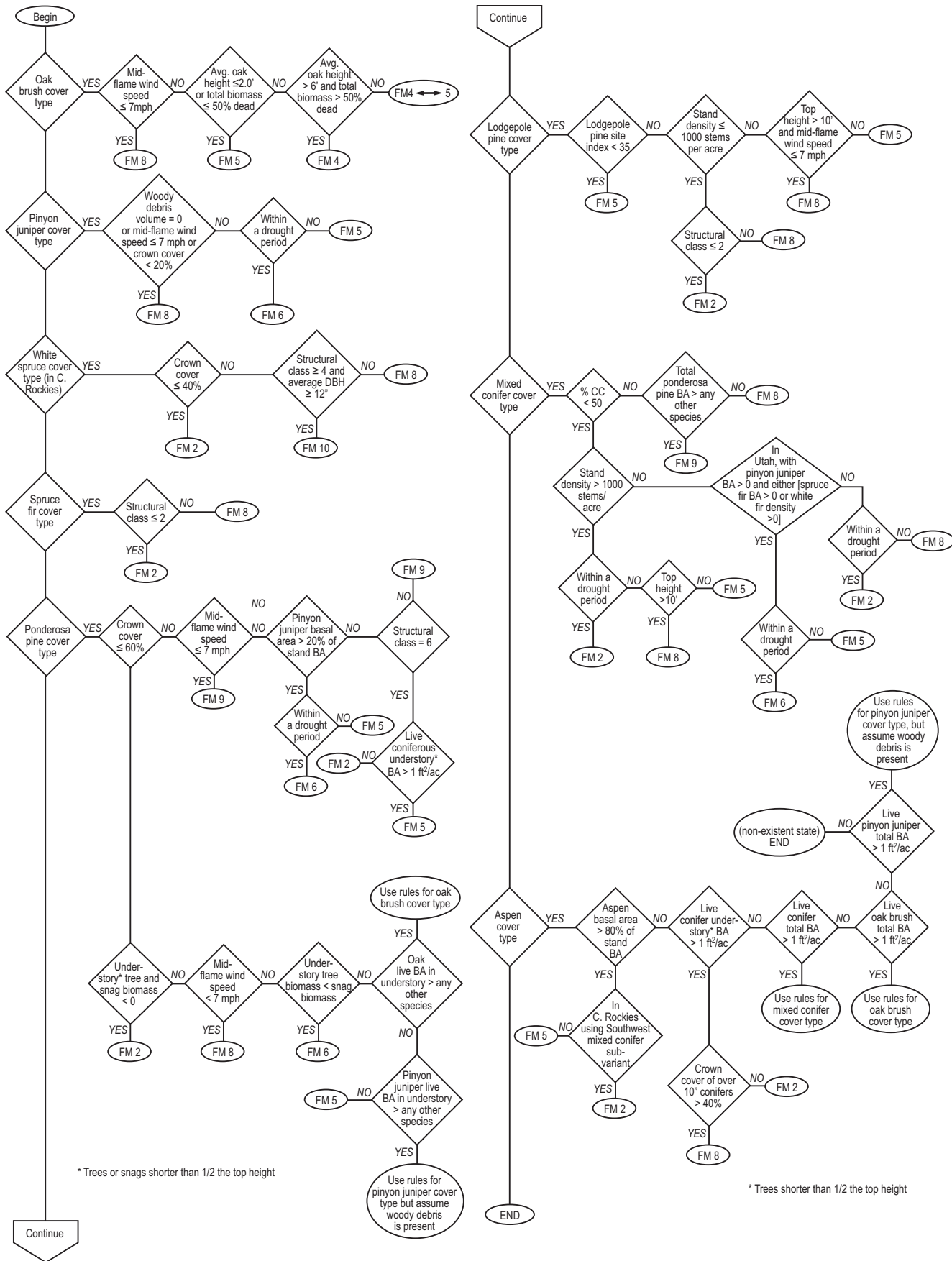

Figure 4.6—Logic for modeling fire at "low" fuel loads in the CR-FFE variant.

4.6 Utah (UT)

4.6.1 Tree Species

The Utah variant models the 13 tree species shown in table 4.56. One additional category, "other" is modeled using whitebark pine.

4.6.2 Snags

The majority of the snag model logic is based on unpublished data provided by Bruce Marcot (USFS, Portland, OR, unpublished data 1995). Snag fall parameters were developed at the FFE design workshop. A complete description of the Snag Submodel is provided in section 2.3 of the FFE "Model Description" chapter.

Four variables are used to modify the Snag Submodel for the different species in the UT-FFE variant:

- A multiplier to modify the species' fall rate
- A multiplier to modify the time required for snags to decay from a "hard" to "soft" state
- The maximum number of years that snags will remain standing
- A multiplier to modify the species' height loss rate

These variables are summarized in tables 4.57 and 4.58.

Height loss rate of quaking aspen is insignificant in comparison to its rapid snag fall rate, and is not modeled. The fall rate of aspen is also halved in the 10 years following a burn. In the case of Douglas-fir and spruce snags greater than 18 inches DBH, the fall rate is reduced to 32 percent of the rate predicted by Marcot's equation

Snag bole volume is determined in using the base FVS model equations. The coefficients shown in table 4.59 are used to convert volume to biomass. Soft snags have 80 percent the density of hard snags.

Snag dynamics can be modified by the user using the **SNAGBRK**, **SNAGFALL**, **SNAGDCAY** and **SNAGPBN** keywords described in the FFE "Model Description" chapter.

Table 4.56—Tree species simulated by the Utah variant.

Common name	Scientific name	Notes
whitebark pine	<i>Pinus albicaulis</i>	
limber pine	<i>Pinus flexilis</i>	
Douglas-fir	<i>Pseudotsuga menziesii</i>	
white fir	<i>Abies concolor</i>	
blue spruce	<i>Picea pungens</i>	
quaking aspen	<i>Populus tremuloides</i>	
lodgepole pine	<i>Pinus contorta</i>	
Engelmann spruce	<i>Picea engelmannii</i>	
subalpine fir	<i>Abies lasiocarpa</i>	
ponderosa pine	<i>Pinus ponderosa</i>	
pinyon pine	<i>Pinus edulis</i>	
western juniper	<i>Juniperus occidentalis</i>	
oak	<i>Quercus spp.</i>	
other		= whitebark pine

Table 4.57—Default snag fall, snag height loss and soft-snag characteristics for 20 inch DBH snags in the UT-FFE variant. These characteristics are derived directly from the parameter values shown in table 4.58.

Species	95% fallen	All down	50% height	Hard-to-soft
-----Years-----				
whitebark pine	31	150	310	35
limber pine	31	150	310	35
Douglas-fir	88 [§]	100	33	42
white fir	12	40	20	35
blue spruce	97 [§]	100	660	35
quaking aspen	8	5	—	35
lodgepole pine	31	150	660	35
Engelmann spruce	97 [§]	100	660	35
subalpine fir	12	40	20	35
ponderosa pine	31	150	310	39
pinyon pine	31	150	310	35
western juniper	31	150	310	35
Oak	12	40	20	35
other	31	150	310	35

[§]This value results from using 32% of the default rate for Douglas-fir and spruce snags >18" DBH, as described in the text.

Table 4.58—Default snag fall, snag height loss and soft-snag multipliers for the UT-FFE. These parameters result in the values shown in table 4.57. (These three columns are the default values used by the SNAGFALL, SNAGBRK, and SNAGDCAY keywords, respectively.)

Species	Snag fall	Height loss	Hard-to-soft
whitebark pine	1.0	0.098	0.9
limber pine	1.0	0.098	0.9
Douglas-fir	1.1 [§]	0.9	1.1
white fir	2.5	1.494	0.9
blue spruce	1.0 [§]	0.046	0.9
quaking aspen	4.0	—	0.9
lodgepole pine	1.0	0.046	0.9
Engelmann spruce	1.0 [§]	0.046	0.9
subalpine fir	2.5	1.494	0.9
ponderosa pine	1.0	0.098	1.0
pinyon pine	1.0	0.098	0.9
western juniper	1.0	0.098	0.9
oak	2.5	1.494	0.9
other	1.0	0.098	0.9

[§]This value applies to Douglas-fir and spruce snags <18" DBH; see text for details.

Table 4.59—Wood density (ovendry lb/ft³) used in the UT-FFE variant.

Species	Density (lb/ft ³)
whitebark pine	24.8
limber pine	24.8
Douglas-fir	30.3
white fir	25.6
blue spruce	25.6
quaking aspen	24.1
lodgepole pine	26.4
Engelmann spruce	22.6
subalpine fir	21.1
ponderosa pine	26.4
pinyon pine	31.8
western juniper	34.9
oak	39.6
other	24.8

4.6.3 Fuels

Information on live fuels was developed using FOFEM 4.0 (Reinhardt and others 1997) and FOFEM 5.0 (Reinhardt and others 2001) and in cooperation with Jim Brown (USFS, Missoula, MT pers. comm. 1995). A complete description of the Fuel Submodel is provided in section 2.4 of the FFE “Model Description” chapter.

Fuels are divided into to four categories: live tree bole, live tree crown, live herb and shrub, and down woody debris (DWD). Live herb and shrub fuel load, and initial DWD are assigned based on the cover species with greatest basal area. If there is no basal area in the first simulation cycle (a “bare ground” stand) then the initial fuel loads are assigned by the vegetation code provided with the **STDINFO** keyword. If the vegetation code is missing or does not identify an overstory species, the model uses a ponderosa pine cover type to assign the default fuels. If there is no basal area in other cycles of the simulation (after a simulated clearcut, for example) herb and shrub fuel biomass is assigned by the previous cover type.

Live Tree Bole: The fuel contribution of live trees is divided into two components: bole and crown. Bole volume is transferred to the FFE after being computed by the FVS model, then converted to biomass using ovendry wood density calculated from table 4-3a and equation 3-5 of The Wood Handbook (Forest Products Laboratory 1999). The coefficient in table 4.59 for Douglas-fir is based on Douglas-fir south.

Tree Crown: As described in the section 2.2 of the FFE “Model Description” chapter, equations in Brown and Johnston (1976) provide estimates of live and dead crown material for most species in the UT-FFE (table 4.60). Pinyon pine, juniper, and Gambel oak may have single or multiple stem forms: single stem equations were used to compute biomass in all cases within the FFE. The FVS base model computes volume of these three species based on firewood utilization with a minimum branch of diameter of 1.5 inches. Crown and bole dynamics compatibility were maintained by defining

Table 4.60—The crown biomass equations listed here determine the biomass of foliage, branch, and stem wood. Species mappings are done for species for which equations are not available.

Species	Species mapping and equation source
whitebark pine	Brown (1978)
limber pine	lodgepole pine: Brown and Johnston (1976)
Douglas-fir	Brown and Johnston (1976)
white fir	grand fir: Brown and Johnston (1976)
blue spruce	Engelmann spruce: Brown and Johnston (1976)
quaking aspen	Ruark (1987) <1" DBH, Standish and others (1985) >1" DBH
lodgepole pine	Brown and Johnston (1976)
Engelmann spruce	Brown and Johnston (1976)
subalpine fir	Brown and Johnston (1976)
ponderosa pine	Brown and Johnston (1976)
pinyon pine	Chojnacky (1992), Grier and others (1992)
western juniper	Chojnacky (1992), Grier and others (1992)
oak	Chojnacky (1992)
other	whitebark pine; Brown (1978)

tree crown as being made up of branches and twigs (including dead material) less than 1.5 inches, and foliage.

Live leaf lifespan is used to simulate the contribution of needles and leaves to annual litter fall. Dead foliage and branch materials also contribute to litter fall, at the rates shown in table 4.61. Each year the inverse of the lifespan is added to the litter pool from each biomass category. Leaf lifespan data are from Keane and others (1989).

Live Herbs and Shrubs: Live herb and shrub fuels are modeled simply by the FFE. Shrubs and herbs are assigned a biomass value based on total tree canopy cover and dominant overstory species (table 4.62). When there are no trees, habitat type is used to infer the most likely dominant species of

Table 4.61—Life span of live and dead foliage (years) and dead branches for species modeled in the UT-FFE variant.

Species	Live Foliage	Dead			
		Foliage	<0.25"	0.25–1"	>1"
whitebark pine	3	2	10	15	15
limber pine	3	2	10	15	15
Douglas-fir	5	2	10	15	15
white fir	7	2	10	15	15
blue spruce	6	2	10	10	10
quaking aspen	1	2	10	10	10
lodgepole pine	3	2	10	15	15
Engelmann spruce	6	2	10	10	10
subalpine fir	7	2	10	15	15
ponderosa pine	4	2	10	10	10
pinyon pine	3	2	10	15	15
western juniper	4	2	10	15	20
oak	1	1	10	15	15
other	3	2	10	15	15

Table 4.62—Values (dry weight, tons/acre) for live fuels used in the UT-FFE. Biomass is linearly interpolated between the “initiating” (I) and “established” (E) values when canopy cover is between 10 and 60 percent.

Species		Herbs	Shrubs	Notes
whitebark pine	E	0.20	0.10	Use lodgepole pine
	I	0.40	1.00	
limber pine	E	0.20	0.10	Use lodgepole pine
	I	0.40	1.00	
Douglas-fir	E	0.20	0.20	
	I	0.40	2.00	
white fir	E	0.15	0.10	
	I	0.30	2.00	
blue spruce	E	0.15	0.20	Use Engelmann spruce
	I	0.30	2.00	
quaking aspen	E	0.25	0.25	Ottmar and others (2000b)
	I	0.18	1.32	
lodgepole pine	E	0.20	0.10	
	I	0.40	1.00	
Engelmann spruce	E	0.15	0.20	
	I	0.30	2.00	
subalpine fir	E	0.15	0.20	
	I	0.30	2.00	
ponderosa pine	E	0.20	0.25	
	I	0.25	0.10	
pinyon pine	E	0.04	0.05	Ottmar and others (2000b)
	I	0.13	1.63	
western juniper	E	0.04	0.05	Ottmar and others (2000a)
	I	0.13	1.63	
oak	E	0.23	0.22	Ottmar and others (2000a)
	I	0.55	0.35	
other	E	0.20	0.10	Use whitebark pine
	I	0.40	1.00	

the previous stand (“Model Description” chapter, section 2.4.2). When total tree canopy cover is less than 10 percent, herb and shrub biomass is assigned an “initiating” value (the ‘I’ rows from table 4.62). When canopy cover is greater than 60 percent, biomass is assigned an “established” value (the ‘E’ rows). Live fuel loads are linearly interpolated when canopy cover is between 10 and 60 percent. Data are taken from FOFEM 4.0 (Reinhardt and others 1997) with modifications provided by Jim Brown (USFS, Missoula, MT pers. comm., 1995). Data on pinyon pine, western juniper, quaking aspen, and Gambel oak were developed after examining live fuels reported in the Stereo Photo Guides for Quantifying Natural Fuels (Ottmar and others 2000a and Ottmar and others 2000b).

Dead Fuels: Initial default DWD pools are based on overstory species. When there are no trees, habitat type is used to infer the most likely dominant species of the previous stand (“Model Description” chapter, section 2.4.2). Default fuel loadings were provided by Jim Brown (USFS, Missoula, MT pers. comm., 1995) (table 4.63). If tree canopy cover is less than 10 percent, the DWD pools are assigned an “initiating” value and if cover is greater than 60 percent they are assigned the “established” value. Fuels are linearly interpolated when canopy cover is between 10 and 60 percent. Initial fuel loads can be modified using the **FUELINIT** keyword.

Table 4.63—Canopy cover and cover type are used to assign default dead fuel loads (tons/acre) by size class for established (E) and initiating (I) stands.

Species		Size class (inches)						Litter	Duff
		< 0.25	0.25 – 1	1 – 3	3 – 6	6 – 12	> 12		
whitebark pine	E	0.9	0.9	1.2	7.0	8.0	0.0	0.6	15.0
	I	0.6	0.7	0.8	2.8	3.2	0.0	0.3	7.0
limber pine	E	0.9	0.9	1.2	7.0	8.0	0.0	0.6	15.0
	I	0.6	0.7	0.8	2.8	3.2	0.0	0.3	7.0
Douglas-fir	E	0.9	0.9	1.6	3.5	3.5	0.0	0.6	15.0
	I	0.5	0.5	1.0	1.4	1.4	0.0	0.3	5.0
white fir	E	0.7	0.7	3.0	7.0	7.0	0.0	0.6	25.0
	I	0.5	0.5	2.0	2.8	2.8	0.0	0.3	12.0
blue spruce	E	1.1	1.1	2.2	10.0	10.0	0.0	0.6	30.0
	I	0.7	0.7	1.6	4.0	4.0	0.0	0.3	12.0
quaking aspen	E	0.2	0.6	2.4	3.6	5.6	0.0	1.4	16.8
	I	0.1	0.4	5.0	2.2	2.3	0.0	0.8	5.6
lodgepole pine	E	0.9	0.9	1.2	7.0	8.0	0.0	0.6	15.0
	I	0.6	0.7	0.8	2.8	3.2	0.0	0.3	7.0
Engelmann spruce	E	1.1	1.1	2.2	10.0	10.0	0.0	0.6	30.0
	I	0.7	0.7	1.6	4.0	4.0	0.0	0.3	12.0
subalpine fir	E	1.1	1.1	2.2	10.0	10.0	0.0	0.6	30.0
	I	0.7	0.7	1.6	4.0	4.0	0.0	0.3	12.0
ponderosa pine	E	0.7	0.7	1.6	2.5	2.5	0.0	1.4	5.0
	I	0.1	0.1	0.2	0.5	0.5	0.0	0.5	0.8
pinyon pine	E	0.2	0.8	2.3	1.4	3.0	0.0	9.3	0.0
	I	0.0	0.1	0.0	0.0	0.0	0.0	2.0	0.0
western juniper	E	0.2	0.8	2.3	1.4	3.0	0.0	9.3	0.0
	I	0.0	0.1	0.0	0.0	0.0	0.0	2.0	0.0
oak	E	0.3	0.7	1.4	0.2	0.1	0.0	3.9	0.0
	I	0.1	0.1	0.0	0.0	0.0	0.0	2.9	0.0
other	E	0.9	0.9	1.2	7.0	8.0	0.0	0.6	15.0
	I	0.6	0.7	0.8	2.8	3.2	0.0	0.3	7.0

4.6.4 Bark Thickness

Bark thickness contributes to predicted tree mortality from simulated fires. The bark thickness multipliers in table 4.64 are used to calculate single bark thickness as described in the “Model Description” chapter, section 2.5.5. The bark thickness equation used in the mortality equation is unrelated to the bark thickness used in the base FVS model. Data are from FOFEM 5.0 (Reinhardt and others 2001). The pinyon pine coefficient is based on *Pinus spp* from FOFEM.

4.6.5 Decay Rate

Decay of down material is simulated by applying loss rates to biomass in categories based on the original size-class of the branch and bole pieces as described in section 2.4.5 of the “Model Description” chapter (table 4.65). Workshop participants noted that material decays slower in the area covered by the UT-FFE. This comment was supported by data in Brown and others (1998). Decay rate for woody material was therefore reduced 55 percent from the default decay rates based on Abbott and Crossley (1982). A portion of the loss is added to the duff pool each year. Loss rates are for hard material; soft material in all size classes, except litter and duff, decays 10 percent faster.

Table 4.64—Species specific constants for determining single bark thickness.

Species	Multiplier (V_{sp})
whitebark pine	0.030
limber pine	0.030
Douglas-fir	0.063
white fir	0.048
blue spruce	0.031
quaking aspen	0.044
lodgepole pine	0.028
Engelmann spruce	0.036
subalpine fir	0.041
ponderosa pine	0.063
pinyon pine	0.030
western juniper	0.025
oak	0.045
other	0.030

Table 4.65—Default annual loss rates are applied based on size class. A portion of the loss is added to the duff pool each year. Loss rates are for hard material. The rates for woody material are 55 percent lower than the rates used in the NI-FFE variant. If present, soft material in all size classes except litter and duff decays 10 percent faster.

Size class (inches)	Annual loss rate	Proportion of loss becoming duff
< 0.25	0.054	0.02
0.25 — 1		
1 — 3	0.041	
3 — 6	0.0068	
6 — 12		
> 12		
Litter	0.50	0.0
Duff	0.002	

By default, the FFE decays all wood species at the rates shown in table 4.65. The decay rates of species groups may be modified by users, who can provide rates to the four decay classes shown in table 4.66 using the **FUELDCAY** keyword. Users can also reassign species to different classes using the **FUELPOOL** keyword.

4.6.6 Moisture Content

Moisture content of the live and dead fuels is used to calculate fire intensity and fuel consumption (“Model Description” chapter, section 2.5.2). Users can choose from four predefined moisture groups (table 4.67) or they can specify moisture conditions for each class using the **MOISTURE** keyword.

Table 4.66—Default wood decay classes used in the UT-FFE variant. Classes are from *The Wood Handbook* (1999). (1 = exceptionally high; 2 = resistant or very resistant; 3 = moderately resistant, and 4 = slightly or nonresistant.)

Species	Decay class
whitebark pine	4
limber pine	4
Douglas-fir	3
white fir	4
blue spruce	4
quaking aspen	4
lodgepole pine	4
Engelmann spruce	4
subalpine fir	4
ponderosa pine	4
pinyon pine	4
western juniper	2
oak	2
other	4

Table 4.67—Moisture values, which alter fire intensity and consumption, have been predefined for four groups. In general they are drier than the default values used in the NI-FFE.

Size class	Moisture group			
	Very dry	Dry	Moist	Wet
0 – 0.25 in. (1-hr)	4	5	8	10
0.25 – 1.0 in. (10-hr)	4	6	10	12
1.0 – 3.0 in. (100-hr)	5	8	12	15
> 3.0 in. (1000+ -hr)	10	15	16	18
Duff	15	50	125	200
Live	70	90	120	140

4.6.7 Fire Behavior Fuel Models

Fire behavior fuel models (Anderson 1982) are used to estimate flame length and fire effects stemming from flame length. Fuel models are determined using fuel load and stand attributes (“Model Description” chapter, section 2.4.8) specific to each FFE variant. In addition, stand management actions such as thinning and harvesting can abruptly increase fuel loads and can trigger “Activity Fuels” conditions, resulting in the selection of alternative fuel models. At their discretion, FFE users have the option of:

1. Defining and using their own fuel models
2. Defining the choice of fuel models and weights
3. Allowing the FFE variant to determine a weighted set of fuel models
4. Allowing the FFE variant to determine a weighted set of fuel models, then using the dominant model

This section explains the steps taken by the UT-FFE to follow the third and fourth of these four options

When the combination of large and small fuel lies in the lower left corner of the graph shown in figure 4.7, one or more low-fuel fuel models become candidate models. In other regions of the graph, other fuel models may also be candidates. The logical flow shown in figure 4.8 defines which low fuel model(s) will become candidates. According to the logic of figure 4.8, only a single fuel model will be chosen for a given stand structure. Consequently, as a stand undergoes structural changes due to management or maturation, the selected fire model can jump from one model selection to another, which in turn may cause abrupt changes in predicted fire behavior. To smooth out changes resulting from changes in fuel model, the strict logic is augmented by linear transitions between states that involve continuous variables (for example, percent canopy cover, average height, snag density, and so forth).

The programme logic shown in figure 4.8 also uses stand structure classes in some decision rules. The UT-FFE uses the default structure class rules documented in Crookston and Stage (1999) unless model users alter those definitions using the **STRCLS** keyword.

If the **STATFUEL** keyword is selected, fuel model is determined by using only the closest match fuel model identified by either figure 4.7 or figure 4.8. The **FLAMEADJ** keyword allows the user to scale the calculated flame length or override the calculated flame length with a value they choose.

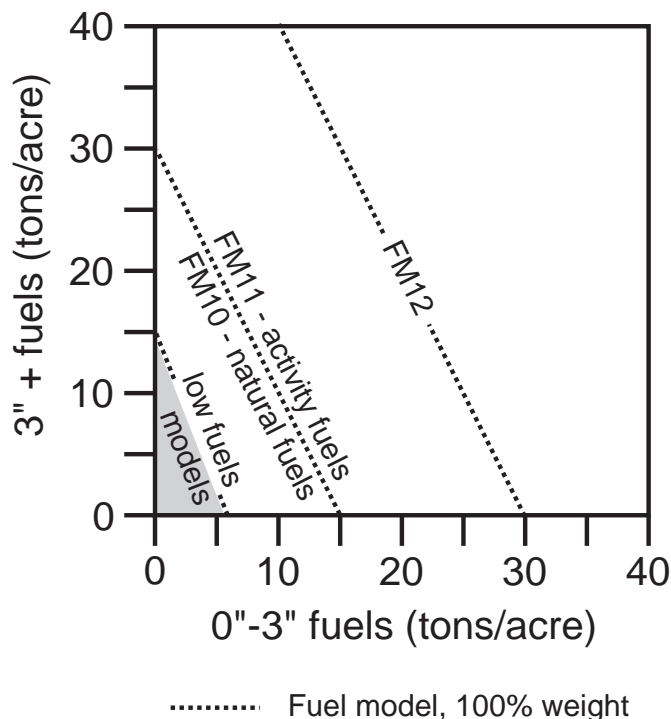

Figure 4.7—If large and small fuels map to the shaded area, candidate fuel models are determined using the logic shown in figure 4.8. Otherwise, flame length is based on the distance to the closest fuel models, identified by the dashed lines, and on recent management (see “Model Description” chapter, section 2.4.8 for further details).

4.7 Western Sierras (WS)

4.7.1 Tree Species

The Western Sierras variant models the 10 tree species shown in table 4.68. Two additional categories, “other hardwoods” and “other softwoods” are modeled using California black oak and lodgepole pine, respectively.

4.7.2 Snags

The majority of the snag model logic is based on unpublished data provided by Bruce Marcot (USFS, Portland, OR, unpublished data 1995). Snag fall parameters were developed at the WS-FFE workshop. A complete description of the Snag Submodel is provided in section 2.3 of the FFE “Model Description” chapter.

Three variables are used to modify the Snag Submodel for the different species in the WS-FFE variant:

- A multiplier to modify the species’ fall rate
- The maximum number of years that snags will remain standing
- A multiplier to modify the species’ height loss rate

These variables are summarized in tables 4.69 and 4.70.

Unlike the some other FFE variants, snags in the WS-FFE do not decay from a hard to soft state. Users can initialize soft snags using the **SNAGINIT** keyword if they wish, but these initialized soft snags will eventually disappear as they are removed by snag fall. In addition, snags lose height only until they are reduced to half the height of the original live tree. The maximum standing lifetime for many snag species is set to 100 years (Mike Landram, USFS, Vallejo, CA, pers. comm., 2000). Finally, the default coefficient for snag height loss is changed from 0.0228 to 0.03406.

Snag bole volume is determined in using the base FVS model equations. The coefficients shown in table 4.71 are used to convert volume to biomass.

Table 4.68—Tree species simulated by the Western Sierras variant.

Common name	Scientific name	Notes
sugar pine	<i>Pinus lambertiana</i>	
Douglas-fir	<i>Pseudotsuga menziesii</i>	
white fir	<i>Abies concolor</i>	
giant sequoia	<i>Sequoiadendron giganteum</i>	= <i>Sequoia gigantea</i>
incense-cedar	<i>Calocedrus decurrens</i>	= <i>Libocedrus decurrens</i>
California black oak	<i>Quercus kelloggii</i>	
Jeffrey pine	<i>Pinus jeffreyi</i>	
red fir	<i>Abies magnifica</i>	
ponderosa pine	<i>Pinus ponderosa</i>	
tanoak, giant chinkapin	<i>Lithocarpus densiflorus</i> , <i>Castanopsis chrysophylla</i>	
other hardwood		= California black oak
other softwood		= lodgepole pine

Table 4.69—Default snag fall, snag height loss and soft-snag characteristics for 20 inch DBH snags in the WS-FFE variant. These characteristics are derived directly from the parameter values shown in table 4.70.

Species	95% fallen	All down	50% height	Hard-to-soft
-----Years-----				
sugar pine	17	100	20	—
Douglas-fir	30	100	20	—
white fir	30	40	20	—
giant sequoia	30	150	20	—
incense-cedar	30	100	20	—
California black oak	30	100	20	—
Jeffrey pine	17	100	20	—
red fir	30	40	20	—
ponderosa pine	17	100	20	—
tanoak, giant chinkapin	30	100	20	—
other hardwood	30	100	20	—
other softwood	17	100	20	—

Table 4.70—Default snag fall, snag height loss and soft-snag multipliers for the WS-FFE. These parameters result in the values shown in table 4.69. (These three columns are the default values used by the SNAGFALL, SNAGBRK, and SNAGDCAY keywords, respectively.)

Species	Snag fall	Height loss	Hard-to-soft
sugar pine	1.79	1.49	—
Douglas-fir	1.02	1.49	—
white fir	1.02	1.49	—
giant sequoia	1.02	1.49	—
Incense-cedar	1.02	1.49	—
California black oak	1.02	1.49	—
Jeffrey pine	1.79	1.49	—
red fir	1.02	1.49	—
ponderosa pine	1.79	1.49	—
tanoak, giant chinkapin	1.02	1.49	—
other hardwood	1.02	1.49	—
other softwood	1.79	1.49	—

Table 4.71—Wood density (ovendry lb/ft³) used in the WS-FFE variant.

Species	Density (lb/ft ³)
sugar pine	23.3
Douglas-fir	32.7
white fir	25.6
giant sequoia	23.3
incense-cedar	24.1
California black oak	41.0
Jeffrey pine	23.3
red fir	24.8
ponderosa pine	26.4
tanoak, giant chinkapin	42.7
other hardwood	41.0
other softwood	26.4

4.7.3 Fuels

Information on live fuels was developed using FOFEM 4.0 (Reinhardt and others 1997) and FOFEM 5.0 (Reinhardt and others 2001) and in cooperation with Jim Brown (USFS, Missoula, MT pers. comm. 1995). A complete description of the Fuel Submodel is provided in section 2.4 of the FFE “Model Description” chapter.

Fuels are divided into to four categories: live tree bole, live tree crown, live herb and shrub, and down woody debris (DWD). Live herb and shrub fuel load, and initial DWD are assigned based on the cover species with greatest basal area. If there is no basal area in the first simulation cycle (a “bare ground” stand) then the initial fuel loads are assigned by the vegetation code provided with the **STDINFO** keyword. If the vegetation code is missing or does not identify an overstory species, the model uses a ponderosa pine cover type to assign the default fuels. If there is no basal area in other cycles of the simulation (after a simulated clearcut, for example) herb and shrub fuel biomass is assigned by the previous cover type.

Live Tree Bole: The fuel contribution of live trees is divided into two components: bole and crown. Bole volume is transferred to the FFE after being computed by the FVS model, then converted to biomass using oven-dry wood density calculated from table 4-3a and equation 3-5 of The Wood Handbook (Forest Products Laboratory 1999). The coefficients in table 4.71 for giant sequoia are based on Redwood Young-growth; Douglas-fir is based on Douglas-fir Interior west.

Tree Crown: As described in the section 2.2 of the FFE “Model Description” chapter, equations in Brown and Johnston (1976) provide estimates of live and dead crown material for most species in the WS-FFE. Some species mappings are used, as shown below in table 4.72. California black oak and tanoak/giant chinkapin crown biomass equations are taken from new sources.

Live leaf lifespan is used to simulate the contribution of needles and leaves to annual litter fall. Dead foliage and branch materials also contribute to litter fall, at the rates shown in table 4.73. Each year the inverse of the

Table 4.72—The crown biomass equations listed here determine the biomass of foliage, branch, and stem wood. Species mappings are done for species for which equations are not available.

Species	Species mapping and equation source
sugar pine	western white pine (Brown and Johnston 1976)
Douglas-fir	Brown and Johnston 1976
white fir	grand fir (Brown and Johnston 1976)
giant sequoia	western redcedar for biomass, western hemlock for partitioning (Mike Lander, pers. comm.; Brown and Johnston 1976)
incense-cedar	western redcedar (Brown and Johnston 1976)
California black oak	Snell and Little 1983; Snell 1979
Jeffrey pine	western white pine (Brown and Johnston 1976)
red fir	grand fir (Brown and Johnston 1976)
ponderosa pine	Brown and Johnston 1976
tanoak, giant chinkapin	Snell and Little 1983, Snell 1979
other conifers	lodgepole pine (Brown and Johnston 1976)
other hardwoods	California black oak (Snell and Little 1983, Snell 1979)

Table 4.73—Life span of live and dead foliage (years) and dead branches for species modeled in the WS-FFE variant.

Species	Live	Dead			
	Foliage	Foliage	<0.25"	0.25–1"	>1"
sugar pine	3	3	10	15	15
Douglas-fir	5	3	10	15	15
white fir	7	3	10	15	15
giant sequoia	5	3	10	15	20
incense-cedar	5	1	10	15	20
California black oak	1	1	10	15	15
Jeffrey pine	3	3	10	15	15
red fir	7	3	10	15	15
ponderosa pine	3	3	10	10	10
tanoak, giant chinkapin	1	1	10	15	15
other conifers	3	3	10	15	15
other hardwoods	1	1	10	15	15

lifespan is added to the litter pool from each biomass category. These data are from the values provided at the WS-FFE workshop.

Live Herbs and Shrubs: Live herb and shrub fuels are modeled simply by the FFE. Shrubs and herbs are assigned a biomass value based on total tree canopy cover and dominant overstory species (table 4.74). When there are no trees, habitat type is used to infer the most likely dominant species of

Table 4.74—Values (dry weight, tons/acre) for live fuels used in the WS-FFE. Biomass is linearly interpolated between the “initiating” (I) and “established” (E) values when canopy cover is between 10 and 60 percent.

Species		Herbs	Shrubs	Notes
sugar pine	E	0.20	0.10	Use lodgepole pine (NI-FFE)
	I	0.40	1.00	
Douglas-fir	E	0.20	0.20	
	I	0.40	2.00	
white fir	E	0.15	0.10	Use grand fir (NI-FFE)
	I	0.30	2.00	
giant sequoia	E	0.20	0.20	Use Douglas-fir
	I	0.40	2.00	
incense-cedar	E	0.20	0.20	Use Douglas-fir
	I	0.40	2.00	
California black oak	E	0.25	0.25	Chojnacky (1992)
	I	0.18	1.32	
Jeffrey pine	E	0.20	0.10	Use lodgepole pine
	I	0.40	1.00	
red fir	E	0.15	0.10	Use grand fir
	I	0.30	2.00	
ponderosa pine	E	0.20	0.25	
	I	0.25	1.00	
tanoak, giant chinkapin	E	0.25	0.25	Chojnacky (1992)
	I	0.18	2.00	
other conifers	E	0.20	0.10	Use lodgepole pine
	I	0.40	1.00	
other hardwoods	E	0.25	0.25	Chojnacky (1992)
	I	0.18	1.32	

the previous stand (“Model Description” chapter, section 2.4.2). When total tree canopy cover is less than 10 percent, herb and shrub biomass is assigned an “initiating” value (the ‘I’ rows from table 4.74). When canopy cover is greater than 60 percent, biomass is assigned an “established” value (the ‘E’ rows). Live fuel loads are linearly interpolated when canopy cover is between 10 and 60 percent. When more than one species is present, the final estimate is computed by combining the interpolated estimates from the rows (table 4.74) representing the two dominant species. The two estimates are themselves weighted by the relative amount of the two dominant species. Data are taken from FOFEM 4.0 (Reinhardt and others 1997) with modifications provided by Jim Brown (USFS, Missoula, MT pers. comm., 1995). Hardwood estimates are from Gambel oak stands reported by Chojnacky (1992).

Dead Fuels: Initial default DWD pools are based on overstory species. When there are no trees, habitat type is used to infer the most likely dominant species of the previous stand (“Model Description” chapter, section 2.4.2). Default fuel loadings were provided by Jim Brown (USFS, Missoula, MT pers. comm., 1995) (table 4.75). If tree canopy cover is less than 10 percent, the DWD pools are assigned an “initiating” value, and if cover is greater than 60 percent they are assigned the “established” value. Fuels are linearly interpolated when canopy cover is between 10 and 60 percent. When more than one species is present, the final estimate is computed by combining the interpolated estimates from the rows (table 4.75) representing the two dominant species. The two estimates are themselves weighted by the relative amount of the two dominant species. Initial fuel loads can be modified using the **FUELINIT** keyword.

Table 4.75—Canopy cover and cover type are used to assign default down woody debris (tons/acre) by size class for established (E) and initiating (I) stands.

Species		Size class (inches)						Litter	Duff
		< 0.25	0.25 – 1	1 – 3	3 – 6	6 – 12	> 12		
sugar pine	E	0.9	0.9	1.2	7.0	8.0	0.0	0.6	15.0
	I	0.6	0.7	0.8	2.8	3.2	0.0	0.3	7.0
Douglas-fir	E	0.9	0.9	1.6	3.5	3.5	0.0	0.6	10.0
	I	0.5	0.5	1.0	1.4	1.4	0.0	0.3	5.0
white fir	E	0.7	0.7	3.0	7.0	7.0	0.0	0.6	25.0
	I	0.5	0.5	2.0	2.8	2.8	0.0	0.3	12.0
giant sequoia	E	0.9	0.9	1.6	3.5	3.5	0.0	0.6	10.0
	I	0.5	0.5	1.0	1.4	1.4	0.0	0.3	5.0
incense-cedar	E	0.9	0.9	1.6	3.5	3.5	0.0	0.6	10.0
	I	0.5	0.5	1.0	1.4	1.4	0.0	0.3	5.0
California black oak	E	0.2	0.6	2.4	3.6	5.6	0.0	1.4	16.8
	I	0.1	0.4	5.0	2.2	2.3	0.0	0.8	5.6
Jeffrey pine	E	0.9	0.9	1.2	7.0	8.0	0.0	0.6	15.0
	I	0.6	0.7	0.8	2.8	3.2	0.0	0.3	7.0
red fir	E	0.7	0.7	3.0	7.0	7.0	0.0	0.6	25.0
	I	0.5	0.5	2.0	2.8	2.8	0.0	0.3	12.0
ponderosa pine	E	0.9	0.9	1.2	7.0	8.0	0.0	0.6	15.0
	I	0.6	0.7	0.8	2.8	3.2	0.0	0.3	7.0
tanoak, giant chinkapin	E	0.2	0.6	2.4	3.6	5.6	0.0	1.4	16.8
	I	0.1	0.4	5.0	2.2	2.3	0.0	0.8	5.6
other conifers	E	0.9	0.9	1.2	7.0	8.0	0.0	0.6	15.0
	I	0.6	0.7	0.8	2.8	3.2	0.0	0.3	7.0
other hardwoods	E	0.2	0.6	2.4	3.6	5.6	0.0	1.4	16.8
	I	0.1	0.4	5.0	2.2	2.3	0.0	0.8	5.6

4.7.4 Bark Thickness

Bark thickness contributes to predicted tree mortality from simulated fires. The bark thickness multipliers in table 4.76 are used to calculate single bark thickness as described in the “Model Description” chapter, section 2.5.5. The bark thickness equation used in the mortality equation is unrelated to the bark thickness used in the base FVS model. Data are from FOFEM 5.0 (Reinhardt and others 2001).

4.7.5 Decay Rate

Decay of down material is simulated by applying the loss rates shown in table 4.77, as described in section 2.4.5 of the “Model Description” chapter. Default decay rates are based on Abbott and Crossley (1982).

The default decay rates are modified by incorporating information from the Dunning site class. The multipliers shown in table 4.78 modify the default decay rates of table 4.77 by incorporating a measure of site quality and moisture availability.

By default, the FFE decays all wood species at the rates shown in table 4.77. The decay rates of species groups may be modified by users, who can provide rates to the four decay classes shown in table 4.79 using the **FUELDCAY** keyword. Users can also reassign species to different classes using the **FUELPOOL** keyword.

4.7.6 Moisture Content

Moisture content of the live and dead fuels is used to calculate fire intensity and fuel consumption (“Model Description” chapter, section 2.5.2). Users can choose from four predefined moisture groups shown in table 4.80, or they can specify moisture conditions for each class using the **MOISTURE** keyword.

4.7.7 Fire Behavior Fuel Models

Fire behavior fuel models (Anderson 1982) are determined in two steps: determination of cover classification and determination of dominant species. The first step uses tree cover attributes classified by the California Wildlife

Table 4.76—Species specific constants for determining single bark thickness.

Species	Multiplier (V_{sp})
sugar pine	0.072
Douglas-fir	0.063
white fir	0.048
giant sequoia	0.081
incense-cedar	0.060
California black oak	0.030
Jeffrey pine	0.068
red fir	0.039
ponderosa pine	0.063
tanoak, giant chinkapin	0.052
other conifers	0.028
other hardwoods	0.030

Table 4.77—Default annual loss rates are applied based on size class. A portion of the loss is added to the duff pool each year. Loss rates are for hard material. If present, soft material in all size classes except litter and duff decays 10 percent faster.

Size class (inches)	Annual loss rate	Proportion of loss becoming duff
< 0.25	0.025	
0.25 — 1		
1 — 3	0.0125	
3 — 6		0.02
6 — 12	0.02	
> 12		
Litter	0.65	
Duff	0.002	0.0

Table 4.78—The WS-FFE modifies default decay rate (table 4.77) using Dunning Site Code to improve simulated decomposition. Lower Dunning Site Classes indicate moister sites.

Dunning site class	Multiplier
0	1.5
1	1.5
2	1.0
3	1.0
4	1.0
5	0.5

Habitat Relationships (CWHR) system (Mayer and Laudenslayer 1988) shown in table 4.81. The table classifies stands by their canopy cover and the size of the larger trees in the stand, predicting CWHR size class and CWHR density class (the third and fourth columns). The CWHR is a BASIC-language function named “CWHRSizeDensity” that was provided at the WS-FFE workshop. This function is incorporated into the WS-FFE with some minor housekeeping modifications.

Table 4.79—Default wood decay classes used in the WS-FFE variant. Classes are from *The Wood Handbook* (1999). (1 = exceptionally high; 2 = resistant or very resistant; 3 = moderately resistant, and 4 = slightly or nonresistant.)

Species	Decay class
sugar pine	4
Douglas-fir	3
white fir	4
giant sequoia	2
Incense-cedar	2
California black oak	2
Jeffrey pine	4
red fir	4
ponderosa pine	4
tanoak, giant chinkapin	4
other hardwood	2
other softwood	4

Table 4.80—Moisture values, which alter fire intensity and consumption, have been predefined for four groups.

Size class	Moisture group			
	Very dry	Dry	Moist	Wet
0 – 0.25 in. (1 hr.)	3	8	12	12
0.25 – 1.0 in. (10 hr.)	4	8	12	12
1.0 – 3.0 in. (100 hr.)	5	10	14	14
> 3.0 in. (1000+ hr.)	10	15	25	25
Duff	15	50	125	125
Live	70	110	150	150

Table 4.81—California Wildlife Habitat Relationships, as defined by Mayer and Laudenslayer (1988).

Tree size (DBH in.)*	Canopy cover (%)	CWHR size class	CWHR density class	Stand description
< 1	< 10	1	–	Seedlings
1 - 6	10 – 24	2	S	Sapling – sparse
1 - 6	25 – 39	2	P	Sapling – open cover
1 - 6	40 – 59	2	M	Sapling – moderate cover
1 - 6	> 60	2	D	Sapling – dense cover
6 – 11	10 – 24	3	S	Pole tree – sparse
6 – 11	25 – 39	3	P	Pole tree – open cover
6 – 11	40 – 59	3	M	Pole tree – moderate cover
6 – 11	> 60	3	D	Pole tree – dense cover
11 – 24	10 – 24	4	S	Small tree – sparse
11 – 24	25 – 39	4	P	Small tree – open cover
11 – 24	40 – 59	4	M	Small tree – moderate cover
11 – 24	> 60	4	D	Small tree – dense cover
> 24	10 – 24	5	S	Med/Lg tree – sparse
> 24	25 – 39	5	P	Med/Lg tree – open cover
> 24	40 – 59	5	M	Med/Lg tree – moderate cover
> 24	> 60	5	D	Med/Lg tree – dense cover
> 24	> 60	6	–	Multi-layer canopy, dense cover

* QMD of the 75 percent largest trees based on basal area.

The WS-FFE modifies the internal CWHR logic slightly, making use of two additional measures internal to the CWHR: unadjusted percent canopy cover and overlap-adjusted percent canopy cover, respectively. The two kinds of canopy estimates are used in combination with the CWHR logic to create weights for the predicted CWHR density class. Each stand's CWHR density class becomes a combination of one or two adjacent classes. Figure 4.9 shows how the two measures are used to weight the S, P, M or D classes at each timestep of the simulation. When a point (defined by the two kinds of canopy cover estimate) lies on a dashed line in the figure, that CWHR density class is given a 100 percent weight. Otherwise, the distance from the point to the nearest dashed lines is used to create weights for the nearest CWHR density classes.

The second step determines the dominant species. A species is considered dominant if it comprises more than 80 percent of the stand basal area. The search starts with pine and moves down the column of forest types listed in the leftmost column of table 4.82. If no species is dominant, then fir-mixed conifer is the default cover type.

The rules governing table 4.82 select one or two candidate (usually low) fuel models. These are used along with the high fuels models to select the final set of weighted fuel models. The table has been modified from Landram's original table so that with the exception of the right-most column (mature Size Class 6 stands), cells with fuel model 10 or 12 in the original table have been replaced with fuel model 8. This change was made so that when appropriate, the default FFE fuel model logic (described in section 2.4.8 and fig. 2.12 of the FFE "Model Description" chapter) is not constrained in its selection of candidate high fuel models: combinations of fuel models 10, 11, 12, and 12 may still be selected when fuel loads are high. Finally, in order to give table 4.82 priority, fuel model 10 is removed from the list of candidate models when fuel model 11 has been selected from the table.

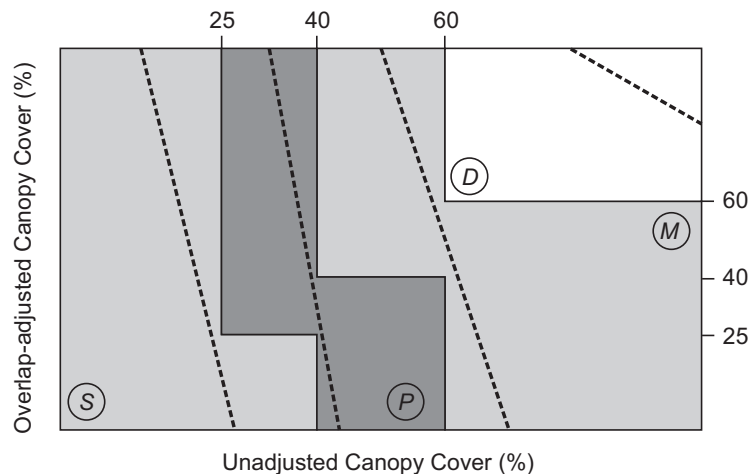

Figure 4.9—Two measures of canopy cover, unadjusted and overlap-adjusted percent canopy cover, are used to derive weighted estimates of the four CWHR density classes (S = sparse, P = open, M = moderate, and D = dense).

Table 4.82—Fire behavior fuels models for the WS-FFE are determined using forest type and CWHR class, as described in the text. The modeling logic allows one or more fuel models to be selected.

Size class	1				2				3				4				5				6
	Density class	S	P	M	D	S	P	M	D	S	P	M	D	S	P	M	D				
Forest type																					
Pine – east side	9	2	2	9	9	2	2	2	9	2	2	8	8	2	2	8	8	10			
Pine – west side	9	5	5	9	9	26	26	25	9	26	26	8	8	26	26	8	8	10			
Red fir	8	8	8	8	8	11	11	8	8	8	8	8	8	8	8	8	8	10			
White fir – east side	8	8	8	8	8	11	11	11	8	8	8	8	8	8	8	8	8	10			
White fir – west side	8	5	5	8	8	11	11	8	8	8	8	8	8	8	8	8	8	10			
Douglas-fir	8	5	5	8	8	5	5	8	8	11	11	9	8	11	11	9	8	10			
Giant sequoia	8	9	9	9	9	9	9	9	9	9	9	9	9	9	9	9	9	10			
Jeffrey pine	9	9	9	9	9	2	2	2	9	2	2	2	9	2	2	2	9	10			
Hardwoods	8	5	5	9	9	11	11	11	9	9	9	9	9	9	9	9	9	10			
Lodgepole pine	8	8	8	8	8	8	8	8	8	8	8	8	8	8	8	8	8	10			
Pine mixed – conifer	9	5	5	9	9	26	26	25	9	26	26	8	8	26	26	8	8	10			
Fir mixed – conifer	8	9	9	8	8	26	26	11	8	5	5	8	8	5	5	8	8	10			
Other softwood	8	8	8	8	8	8	8	8	8	8	8	8	8	8	8	8	8	10			

Fuel models 25 and 26 are custom fuel models developed in California and are described fully in table 2.13 of the FFE “Model Description” chapter. Model 25 is used to describe fire behavior in plantations greater than 25 years old with shrub understory and low crown mass. Model 26 is used on sites similar to those where Model 4 would be used but with lower fuelbed depth and loading.

In some situations a thinning or disturbance may cause one of the selected fuel models to switch from FM8 or FM9 to FM5 or FM26. When this happens, the transition is modified to simulate a delay in brush ingrowth. In the case where an FM8 or FM9 fuel model is predicted to change to FM5, the change is made over 5 years, gradually shifting from FM8 or FM9 to FM5. In the case where the fuel model is predicted to change to FM26, the model first changes to FM5 over 5 years, and then changes to FM26 over the next 10 years, 15 years after the initial disturbance.

Finally, flame length is calculated using the weights from above the appropriate fuel models. The **FLAMEADJ** keyword allows users to scale the calculated flame length or override the calculated flame length with a value they choose.

4.8 Eastern Cascades (EC)

4.8.1 Tree Species

The Eastern Cascades variant models the 10 tree species shown in table 4.83. One additional category, “other” is modeled using mountain hemlock.

4.8.2 Snags

The majority of the snag model logic is based on unpublished data provided by Bruce Marcot (USFS, Portland, OR, unpublished data 1995). Snag fall parameters were developed at the FFE design workshop. A complete description of the Snag Submodel is provided in section 2.3 of the FFE “Model Description” chapter.

Four variables are used to modify the Snag Submodel for the different species in the EC-FFE variant:

- A multiplier to modify the species’ fall rate
- A multiplier to modify the time required for snags to decay from a “hard” to “soft” state
- The maximum number of years that snags will remain standing
- A multiplier to modify the species’ height loss rate

These variables are summarized in tables 4.84 and 4.85.

Snag dynamics are similar to the NI-FFE variant, with the following exceptions:

- Western larch, lodgepole pine, Engelmann spruce, subalpine fir, and ponderosa pine snags experience no height loss, and their height loss multiplier is set to zero.
- Western white pine and western redcedar lose 75 percent of their original height, after which their height does not change.
- Larch and spruce snags greater than 18 inches dbh fall at a rate that is 32 percent of the rate predicted by Marcot’s equation.

Snag bole volume is determined in using the base FVS model equations. The coefficients shown in table 4.86 are used to convert volume to biomass. Soft snags have 80 percent the density of hard snags.

Table 4.83—Tree species simulated by the Eastern Cascades variant.

Common name	Scientific name	Notes
western white pine	<i>Pinus monticola</i>	
western larch	<i>Larix occidentalis</i>	
Douglas-fir	<i>Pseudotsuga menziesii</i>	
Pacific silver fir	<i>Abies amabilis</i>	
western redcedar	<i>Thuja plicata</i>	
grand fir	<i>Abies grandis</i>	
lodgepole pine	<i>Pinus contorta</i>	
Engelmann spruce	<i>Picea engelmannii</i>	
subalpine fir	<i>Abies lasiocarpa</i>	
ponderosa pine	<i>Pinus ponderosa</i>	
other		= mountain hemlock

Table 4.84—Default snag fall, snag height loss and soft-snag characteristics for 15 inch DBH snags in the EC-FFE variant. These characteristics are derived directly from the parameter values shown in table 4.85.

Species	95% fallen	All down	50% height	Hard-to-soft
-----Years-----				
western white pine	27	110	76	36
western larch	24	150	—	36
Douglas-fir	27	75	30	36
Pacific silver fir	27	30	20	29
western redcedar	81	300	101	29
grand fir	22	90	20	29
lodgepole pine	15	35	—	29
Engelmann spruce	20	100	—	29
subalpine fir	30	40	—	29
ponderosa pine	24	100	—	32
other	27	30	20	32

Table 4.85—Default snag fall, snag height loss and soft-snag multipliers for the EC-FFE. These parameters result in the values shown in table 4.84. (These three columns are the default values used by the SNAGFALL, SNAGBRK, and SNAGDCAY keywords, respectively.)

Species	Snag fall	Height loss	Hard-to-soft
western white pine	0.9	0.4	1.1
western larch	1.0 [§]	—	1.1
Douglas-fir	0.9	1.0	1.1
Pacific silver fir	0.9	1.5	0.9
western redcedar	0.3	0.3	0.9
grand fir	1.1	1.5	0.9
lodgepole pine	1.6	—	0.9
Engelmann spruce	1.2 [§]	—	0.9
subalpine fir	0.8	—	0.9
ponderosa pine	1.0	—	1.0
other	0.9	1.5	1.0

[§]This value applies to Douglas-fir and spruce snags <18" DBH; see text for details.

Table 4.86—Wood density (ovendry lb/ft³) used in the EC-FFE variant

Species	Density (lb/ft ³)
western white pine	24.8
western larch	34.3
Douglas-fir	32.7
Pacific silver fir	27.9
western redcedar	21.1
grand fir	24.1
lodgepole pine	26.4
Engelmann spruce	22.6
subalpine fir	21.1
ponderosa pine	26.4
other	29.5

Snag dynamics can be modified by the user using the **SNAGBRK**, **SNAGFALL**, **SNAGDCAY** and **SNAGPBN** keywords described in the FFE “Model Description” chapter.

4.8.3 Fuels

Information on live fuels was developed using FOFEM 4.0 (Reinhardt and others 1997) and FOFEM 5.0 (Reinhardt and others 2001) and in cooperation with Jim Brown (USFS, Missoula, MT pers. comm. 1995). A complete description of the Fuel Submodel is provided in section 2.4 of the FFE “Model Description” chapter.

Fuels are divided into to four categories: live tree bole, live tree crown, live herb and shrub, and down woody debris (DWD). Live herb and shrub fuel load, and initial DWD are assigned based on the cover species with greatest basal area. If there is no basal area in the first simulation cycle (a “bare ground” stand) then the initial fuel loads are assigned by the vegetation code provided with the **STDINFO** keyword. If the vegetation code is missing or does not identify an overstory species, the model uses a ponderosa pine cover type to assign the default fuels. If there is no basal area in other cycles of the simulation (after a simulated clearcut, for example) herb and shrub fuel biomass is assigned by the previous cover type.

Live Tree Bole: The fuel contribution of live trees is divided into two components: bole and crown. Bole volume is transferred to the FFE after being computed by the FVS model, then converted to biomass using oven-dry wood density calculated from table 4-3a and equation 3-5 of The Wood Handbook (Forest Products Laboratory 1999). The coefficient in table 4.86 for Douglas-fir is based on Douglas-fir south.

Tree Crown: As described in the section 2.2 of the FFE “Model Description” chapter, equations in Brown and Johnston (1976) provide estimates of live and dead crown material for most species in the EC-FFE (table 4.87). Mountain hemlock biomass is based on Gholz (1979), using western hemlock equations from Brown and Johnston to partition the biomass and also to provide estimates for trees less than 1 inch diameter.

Table 4.87—The crown biomass equations listed here determine the biomass of foliage, branch, and stem wood. Species mappings are done for species for which equations are not available.

Species	Species mapping and equation source
western white pine	Brown and Johnston (1976)
western larch	Brown and Johnston (1976)
Douglas-fir	Brown and Johnston (1976)
Pacific silver fir	grand fir; Brown and Johnston (1976)
western redcedar	Brown and Johnston (1976)
grand fir	Brown and Johnston (1976)
lodgepole pine	Brown and Johnston (1976)
Engelmann spruce	Brown and Johnston (1976)
subalpine fir	Brown and Johnston (1976)
ponderosa pine	Brown and Johnston (1976)
other	Gholz (1979); Brown and Johnston (1976)

Live leaf lifespan is used to simulate the contribution of needles and leaves to annual litter fall. Dead foliage and branch materials also contribute to litter fall, at the rates shown in table 4.88. Each year the inverse of the lifespan is added to the litter pool from each biomass category. Leaf lifespan data are from Keane and others (1989). Lifespans of western white pine and mountain hemlock are mapped using ponderosa pine, and western hemlock and western redcedar are based on Douglas-fir.

Live Herbs and Shrubs: Live herb and shrub fuels are modeled simply by the FFE. Shrubs and herbs are assigned a biomass value based on total tree canopy cover and dominant overstory species (table 4.89). When there

Table 4.88—Life span of live and dead foliage (years) and dead branches for species modeled in the EC-FFE variant.

Species	Live	Dead			
	Foliage	Foliage	<0.25"	0.25–1"	>1"
western white pine	4	2	5	5	15
western larch	1	1	5	5	15
Douglas-fir	5	2	5	5	15
Pacific silver fir	7	2	5	5	15
western redcedar	5	2	5	5	20
grand fir	7	2	5	5	15
lodgepole pine	3	2	5	5	15
Engelmann spruce	6	2	5	5	10
subalpine fir	7	2	5	5	15
ponderosa pine	4	2	5	5	10
other	4	2	5	5	10

Table 4.89—Values (dry weight, tons/acre) for live fuels used in the EC-FFE. Biomass is linearly interpolated between the “initiating” (I) and “established” (E) values when canopy cover is between 10 and 60 percent.

Species		Herbs	Shrubs	Notes
western white pine	E	0.15	0.10	
	I	0.30	2.00	
western larch	E	0.20	0.20	
	I	0.40	2.00	
Douglas-fir	E	0.20	0.20	
	I	0.40	2.00	
Pacific silver fir	E	0.15	0.10	Use grand fir
	I	0.30	2.00	
western redcedar	E	0.20	0.20	
	I	0.40	2.00	
grand fir	E	0.15	0.10	
	I	0.30	2.00	
lodgepole pine	E	0.20	0.10	
	I	0.40	1.00	
Engelmann spruce	E	0.15	0.20	
	I	0.30	2.00	
subalpine fir	E	0.15	0.20	
	I	0.30	2.00	
ponderosa pine	E	0.20	0.25	
	I	0.25	0.10	
other	E	0.15	0.20	Use spruce-subalpine fir
	I	0.30	2.00	

are no trees, habitat type is used to infer the most likely dominant species of the previous stand (“Model Description” chapter, section 2.4.2). When total tree canopy cover is less than 10 percent, herb and shrub biomass is assigned an “initiating” value (the ‘I’ rows from table 4.89). When canopy cover is greater than 60 percent, biomass is assigned an “established” value (the ‘E’ rows). Live fuel loads are linearly interpolated when canopy cover is between 10 and 60 percent. Data are taken from FOFEM 4.0 (Reinhardt and others 1997) with modifications provided by Jim Brown (USFS, Missoula, MT pers. comm., 1995).

Dead Fuels: Initial default DWD pools are based on overstory species. When there are no trees, habitat type is used to infer the most likely dominant species of the previous stand (“Model Description” chapter, section 2.4.2). Default fuel loadings were provided by Jim Brown (USFS, Missoula, MT pers. comm., 1995) (table 4.90). If tree canopy cover is less than 10 percent, the DWD pools are assigned an “initiating” value, and if cover is greater than 60 percent they are assigned the “established” value. Fuels are linearly interpolated when canopy cover is between 10 and 60 percent. Initial fuel loads can be modified using the **FUELINIT** keyword.

4.8.4 Bark Thickness

Bark thickness contributes to predicted tree mortality from simulated fires. The bark thickness multipliers in table 4.91 are used to calculate single bark thickness as described in the “Model Description” chapter, (section 2.5.5. The bark thickness equation used in the mortality equation is unrelated to the bark thickness used in the base FVS model. Data are from FOFEM 5.0 (Reinhardt and others 2001).

Table 4.90—Canopy cover and cover type are used to assign default down woody debris (tons/acre) by size class for established (E) and initiating (I) stands.

Species		Size class (inches)						Litter	Duff
		< 0.25	0.25 – 1	1 – 3	3 – 6	6 – 12	> 12		
western white pine	E	1.0	1.0	1.6	10.0	10.0	10.0	0.8	30.0
	I	0.6	0.6	0.8	6.0	6.0	6.0	0.4	12.0
western larch	E	0.9	0.9	1.6	3.5	3.5	0.0	0.6	10.0
	I	0.5	0.5	1.0	1.4	1.4	0.0	0.3	5.0
Douglas-fir	E	0.9	0.9	1.6	3.5	3.5	0.0	0.6	10.0
	I	0.5	0.5	1.0	1.4	1.4	0.0	0.3	5.0
Pacific silver fir	E	0.7	0.7	3.0	7.0	7.0	0.0	0.6	25.0
	I	0.5	0.5	2.0	2.8	2.8	0.0	0.3	12.0
western redcedar	E	2.2	2.2	5.2	15.0	20.0	15.0	1.0	35.0
	I	1.6	1.6	3.6	6.0	8.0	6.0	0.5	12.0
grand fir	E	0.7	0.7	3.0	7.0	7.0	0.0	0.6	25.0
	I	0.5	0.5	2.0	2.8	2.8	0.0	0.3	12.0
lodgepole pine	E	0.9	0.9	1.2	7.0	8.0	0.0	0.6	15.0
	I	0.6	0.7	0.8	2.8	3.2	0.0	0.3	7.0
Engelmann spruce	E	1.1	1.1	2.2	10.0	10.0	0.0	0.6	30.0
	I	0.7	0.7	1.6	4.0	4.0	0.0	0.3	12.0
subalpine fir	E	1.1	1.1	2.2	10.0	10.0	0.0	0.6	30.0
	I	0.7	0.7	1.6	4.0	4.0	0.0	0.3	12.0
ponderosa pine	E	0.7	0.7	1.6	2.5	2.5	0.0	1.4	5.0
	I	0.1	0.1	0.2	0.5	0.5	0.0	0.5	0.8
other	E	1.1	1.1	2.2	10.0	10.0	0.0	0.6	30.0
	I	0.7	0.7	1.6	4.0	4.0	0.0	0.3	12.0

Table 4.91—Species specific constants for determining single bark thickness.

Species	Multiplier (V_{sp})
western white pine	0.035
western larch	0.063
Douglas-fir	0.063
Pacific silver fir	0.047
western redcedar	0.035
grand fir	0.046
lodgepole pine	0.028
Engelmann spruce	0.036
subalpine fir	0.041
ponderosa pine	0.063
other	0.040

4.8.5 Decay Rate

Decay of down material is simulated by applying loss rates to biomass in categories based on the original size-class of the branch and bole pieces as described in section 2.4.5 of the “Model Description” chapter. Default decay rates on mesic sites (table 4.92) are based on Abbott and Crossley (1982). A portion of the loss is added to the duff pool each year. Loss rates are for hard material; soft material in all size classes, except litter and duff, decays 10 percent faster.

Decay rates on moist sites are one-third higher than the rates shown in table 4.92; dry sites are one-third lower. The habitat code set by the **STDINFO** keyword determines whether a stand is defined as a moist, mesic,

Table 4.92—Default annual loss rates on mesic sites are applied based on size class. A portion of the loss is added to the duff pool each year. Loss rates are for hard material. If present, soft material in all size classes except litter and duff decays 10 percent faster.

Size class (inches)	Annual loss rate	Proportion of loss becoming duff
< 0.25	0.12	
0.25 — 1		
1 — 3	0.09	
3 — 6		0.02
6 — 12	0.015	
> 12		
Litter	0.50	
Duff	0.002	0.0

or dry site, as shown in table 4.93. These assignments were provided by Tom DeMeo of USFS, Portland, OR, and Terry Lillybridge of USFS, Wenatchee, WA (pers. comm. 2001; based on Williams and others 1983, Williams and others 1990, Williams and others 1995).

The decay rates of species groups may be modified by users, who can provide rates to the four decay classes shown in table 4.94 using the **FUELDCAY** keyword. Users can also reassign species to different classes using the **FUELPOOL** keyword.

Table 4.93—Habitat type - moisture regime relationships for the EC-FFE variant. Moisture classes modify default decay rates, as described in the text.

Habitat type code	Regime	Habitat type code	Regime	Habitat type code	Regime	Habitat type code	Regime
CAG112	Dry	CDS716	Mesic	CFS553	Moist	CWF444	Mesic
CAS311	Mesic	CDS811	Mesic	CFS556	Moist	CWF521	Moist
CCF211	Moist	CDS813	Mesic	CFS558	Moist	CWF522	Moist
CCF212	Moist	CDS814	Mesic	CFS621	Moist	CWF523	Moist
CCF221	Mesic	CDS831	Moist	CHC311	Moist	CWF524	Moist
CCF222	Moist	CDS832	Mesic	CHF223	Moist	CWG121	Dry
CCS211	Moist	CDS833	Mesic	CHF311	Moist	CWG122	Dry
CCS311	Mesic	CEF111	Mesic	CHF312	Moist	CWG123	Dry
CDF411	Dry	CEF211	Moist	CHF313	Moist	CWG124	Dry
CDG123	Dry	CEF222	Moist	CHF422	Moist	CWG125	Mesic
CDG131	Dry	CEF421	Moist	CHF521	Mesic	CWS214	Moist
CDG132	Dry	CEF422	Moist	CHS142	Mesic	CWS221	Moist
CDG134	Dry	CEF423	Moist	CHS143	Moist	CWS222	Moist
CDG141	Dry	CEF424	Moist	CHS144	Moist	CWS223	Moist
CDG311	Dry	CEG121	Moist	CHS225	Moist	CWS224	Mesic
CDG321	Mesic	CEG310	Mesic	CHS226	Moist	CWS225	Mesic
CDG322	Dry	CEG311	Mesic	CHS227	Moist	CWS226	Mesic
CDG323	Dry	CEM211	Moist	CHS411	Moist	CWS331	Dry
CDS231	Dry	CES111	Moist	CHS711	Moist	CWS332	Moist
CDS241	Mesic	CES113	Moist	CLS521	Mesic	CWS335	Dry
CDS411	Dry	CES210	Mesic	CMF131	Moist	CWS336	Dry
CDS412	Dry	CES211	Mesic	CMF131	Moist	CWS337	Dry
CDS631	Dry	CES213	Mesic	CMS121	Moist	CWS338	Dry
CDS632	Dry	CES312	Mesic	CMS122	Moist	CWS421	Dry
CDS633	Mesic	CES313	Mesic	CMS256	Moist	CWS422	Moist
CDS636	Mesic	CES342	Mesic	CMS257	Moist	CWS531	Dry
CDS637	Dry	CES412	Mesic	CMS258	Moist	CWS532	Moist
CDS638	Dry	CES413	Mesic	CMS259	Moist	CWS533	Dry
CDS639	Dry	CES422	Moist	CMS354	Moist	CWS534	Dry
CDS640	Dry	CES423	Moist	CMS355	Moist	CWS535	Mesic
CDS653	Dry	CES424	Mesic	CMS356	Moist	CWS536	Moist
CDS654	Dry	CES425	Mesic	CPG141	Dry	CWS537	Moist
CDS655	Dry	CES426	Mesic	CPG231	Dry	CWS551	Moist
CDS661	Mesic	CFF162	Moist	CPH211	Dry	CWS552	Mesic
CDS662	Dry	CFF254	Moist	CPH212	Dry	CWS553	Moist
CDS673	Dry	CFS232	Moist	CPS241	Dry	CWS554	Dry
CDS674	Dry	CFS233	Moist	CFS553	Moist	CWS821	Moist
CDS675	Dry	CFS234	Moist	CWC511	Moist	HQG111	Dry
CDS715	Dry	CFS542	Moist	CWF321	Moist	HQS211	Dry

Table 4.94—Default wood decay classes used in the EC-FFE variant. Classes are from *The Wood Handbook* (1999). (1 = exceptionally high; 2 = resistant or very resistant; 3 = moderately resistant, and 4 = slightly or nonresistant.)

Species	Decay class
western white pine	4
western larch	3
Douglas-fir	3
Pacific silver fir	4
western redcedar	2
grand fir	4
lodgepole pine	4
Engelmann spruce	4
subalpine fir	4
ponderosa pine	4
other	4

4.8.6 Moisture Content

Moisture content of the live and dead fuels is used to calculate fire intensity and fuel consumption (“Model Description” chapter, section 2.5.2). Users can choose from four predefined moisture groups (table 4.95) or they can specify moisture conditions for each class using the **MOISTURE** keyword.

4.8.7 Fire Behavior Fuel Models

Fire behavior fuel models (Anderson 1982) are used to estimate flame length and fire effects stemming from flame length. Fuel models are determined using fuel load and stand attributes (“Model Description” chapter, section 2.4.8) specific to each FFE variant. In addition, stand management actions such as thinning and harvesting can abruptly increase fuel loads and can trigger “Activity Fuels” conditions, resulting in the selection of alternative fuel models. At their discretion, FFE users have the option of:

1. Defining and using their own fuel models
2. Defining the choice of fuel models and weights
3. Allowing the FFE variant to determine a weighted set of fuel models

Table 4.95—Moisture values, which alter fire intensity and consumption, have been predefined for four groups.

Size class	Moisture group			
	Very dry	Dry	Moist	Wet
0 – 0.25 in. (1-hr)	4	8	12	16
0.25 – 1.0 in. (10-hr)	4	8	12	16
1.0 – 3.0 in. (100-hr)	5	10	14	18
> 3.0 in. (1000+ -hr)	10	15	25	50
Duff	15	50	125	200
Live	70	110	150	150

4. Allowing the FFE variant to determine a weighted set of fuel models, then using the dominant model

This section explains the steps taken by the EC-FFE to follow the third and fourth of these four options.

The fuel model selection logic is based on information provided by Tom Leuschen (USFS, Okanogan, WA pers. comm. 2001). The appropriate fuel model is determined using combinations of categorical measures of cover type, canopy closure (CC), size (QMD), and whether the canopy is composed of a single stratum or is multistoried (Single). The FVS base model provides measures of canopy closure and size, and the base model structural stage logic from Crookston and Stage (1999) determines whether the canopy is single- or multistoried.

There are 11 sets of logical rules, each based on cover type. As described below, one of 15 cover types is used to select from among the 11 flowcharts shown below. If one of these single species:

- Douglas-fir
- subalpine fir
- Pacific silver fir
- lodgepole pine
- ponderosa pine
- white pine
- Engelmann spruce
- western larch
- mountain hemlock

comprises more than half the stand basal area, then that species' flowchart will be used. Failing that, these combinations of two species are searched for:

- Douglas-fir/grand fir
- ponderosa pine/Douglas-fir
- lodgepole pine/western larch

and the corresponding cover type flowchart is used. If a cover type has not been selected yet, these three cover types are searched in order:

- subalpine fir leading
- moist habitat mixed conifer
- dry habitat mixed conifer

Moist and dry habitats are based on the habitat code provided by the **STDINFO** keyword, using the classification shown in table 4.93.

When the combination of large and small fuel lies in the lower left corner of the graph shown in figure 4.10, one or more low-fuel fuel models become candidate models. In other regions of the graph, other fuel models may also be candidates. The cover types described above, along with the flow diagrams in figure 4.11, define which low fuel model(s) will become candidates. According to the logic of the figure, only a single fuel model will be chosen for a given stand structure. Consequently, as a stand undergoes structural changes due to management or maturation, the selected fire model can jump from one model selection to another, which in turn may cause abrupt changes in predicted fire behavior. To smooth out changes resulting from changes in

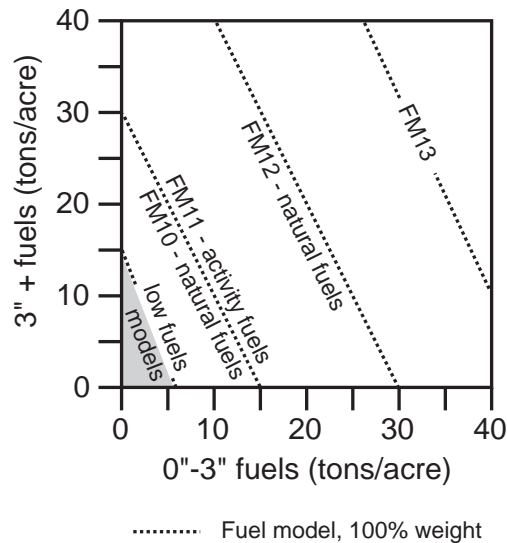

Figure 4.10—If large and small fuels map to the shaded area, candidate fuel models are determined using the logic shown in figure 4.11. Otherwise, flame length is based on the distance to the closest fuel models, and on recent management (see “Model Description” chapter, section 2.4.8 for further details).

fuel model, the strict logic is augmented by linear transitions between states that involve continuous variables (for example, percent canopy cover, average height, snag density, and so forth).

If the **STATFUEL** keyword is selected, fuel model is determined by using only the closest match fuel model identified by either figure 4.10 or figure 4.11. The **FLAMEADJ** keyword allows the user to scale the calculated flame length or override the calculated flame length with a value they choose.

Douglas-fir

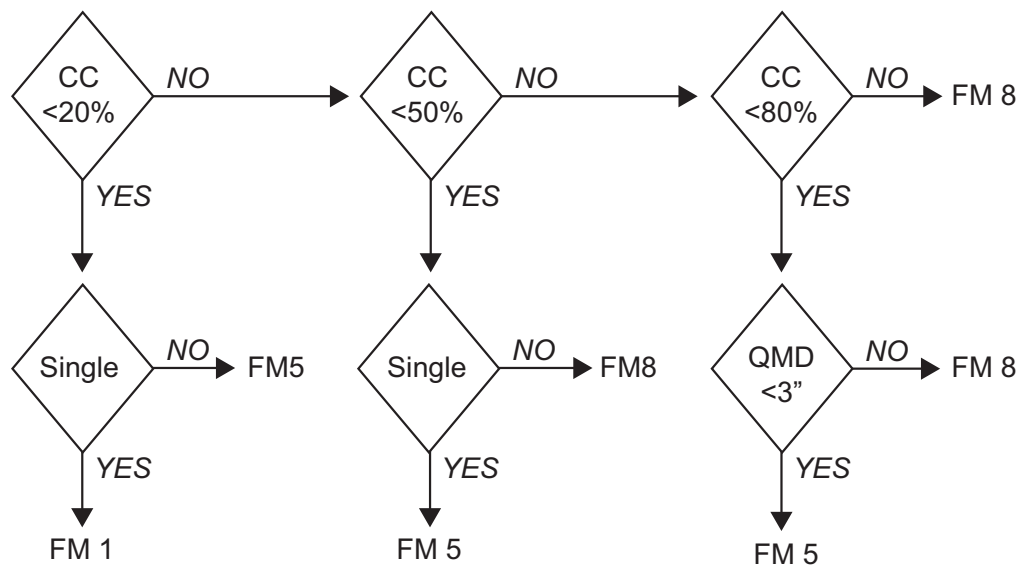
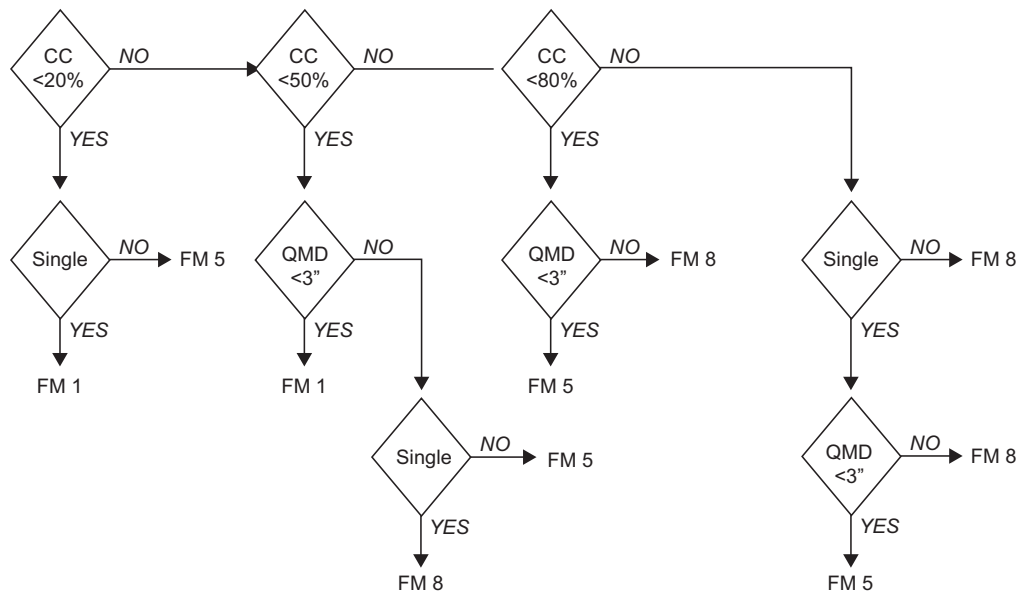
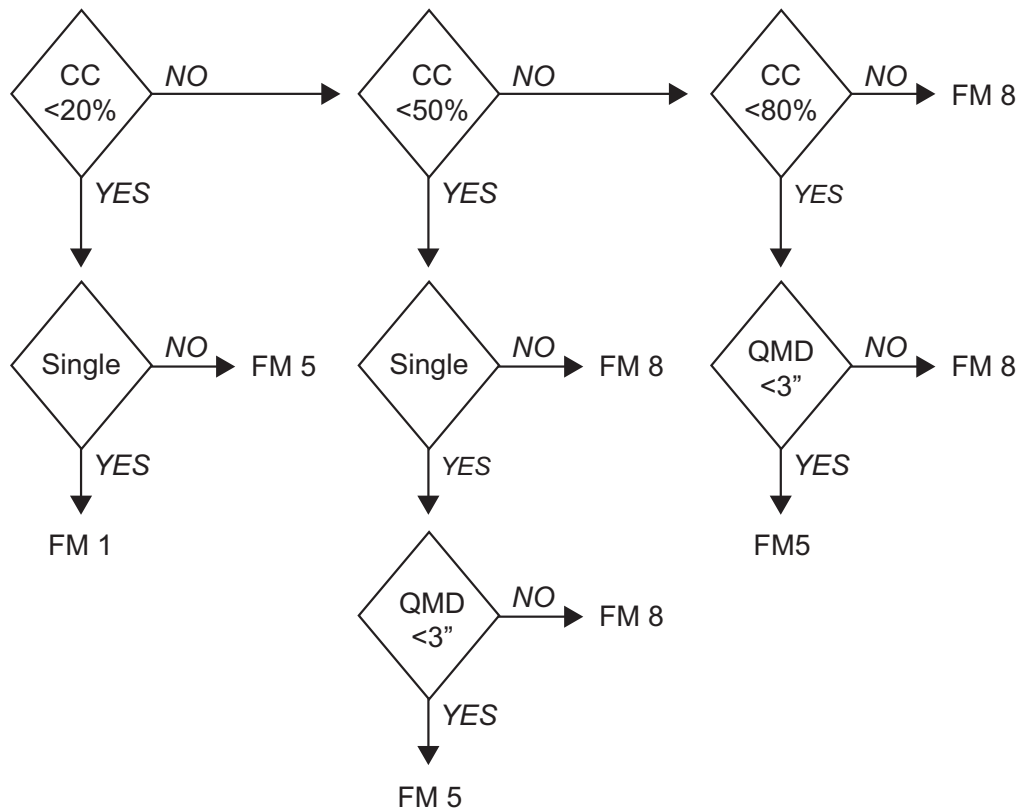

Figure 4.11—Logic for modeling fire at “low” fuel loads in the EC-FFE variant.

Lodgepole pine, white pine



Subalpine fir, subalpine fir mixture



Mountain hemlock, Pacific silver fir, Douglas-fir/grand fir

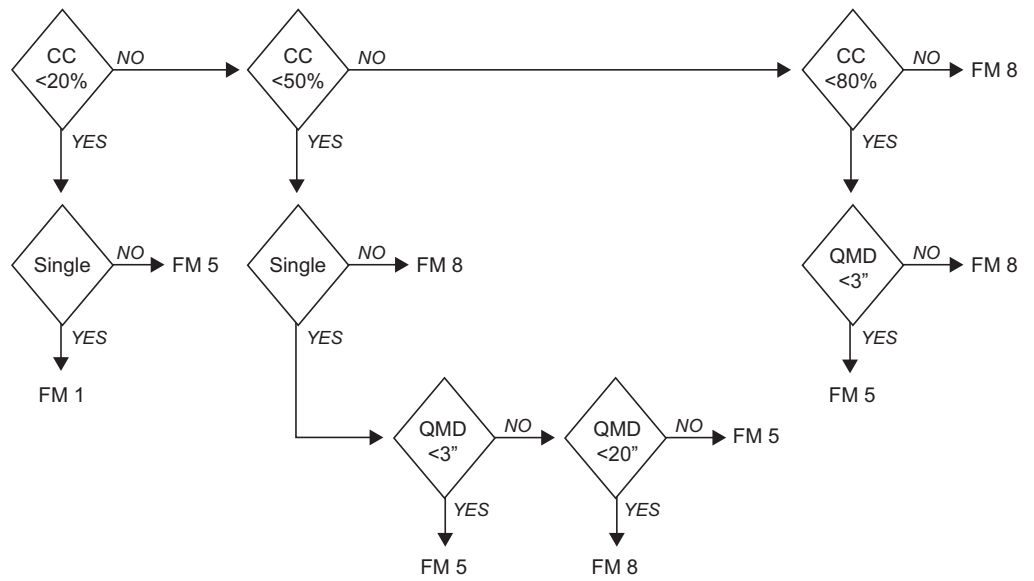

Engelmann spruce

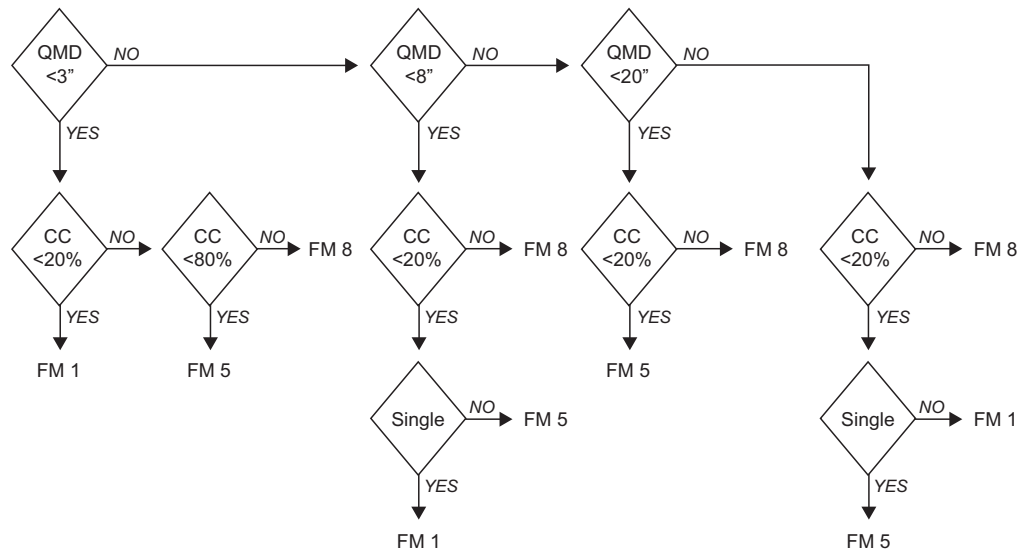

Western larch

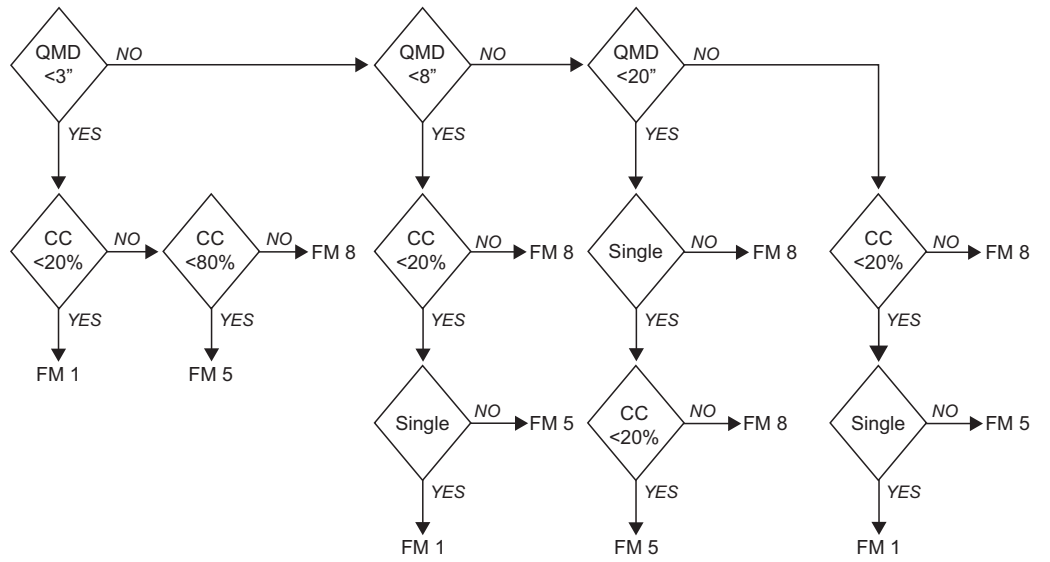

Ponderosa pine

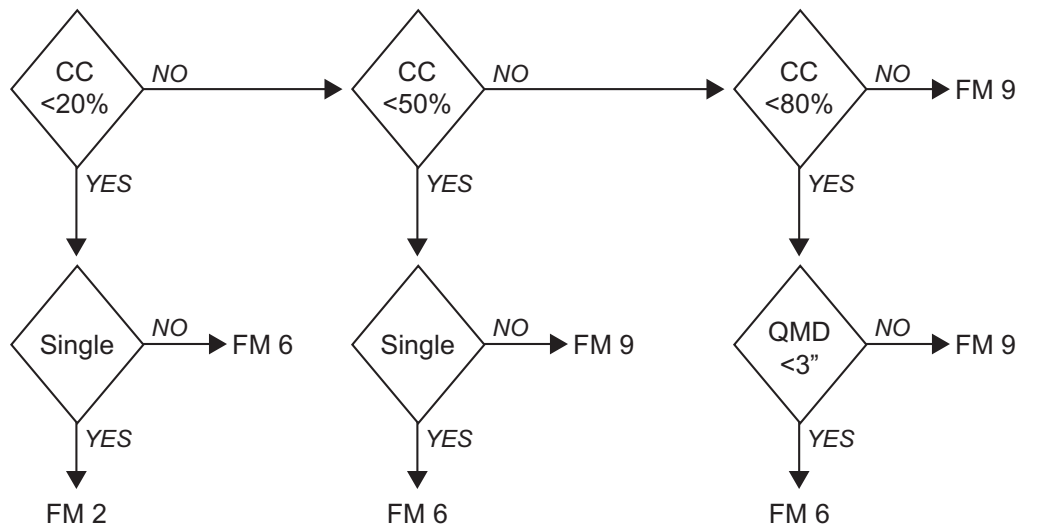

Ponderosa pine, Douglas-fir

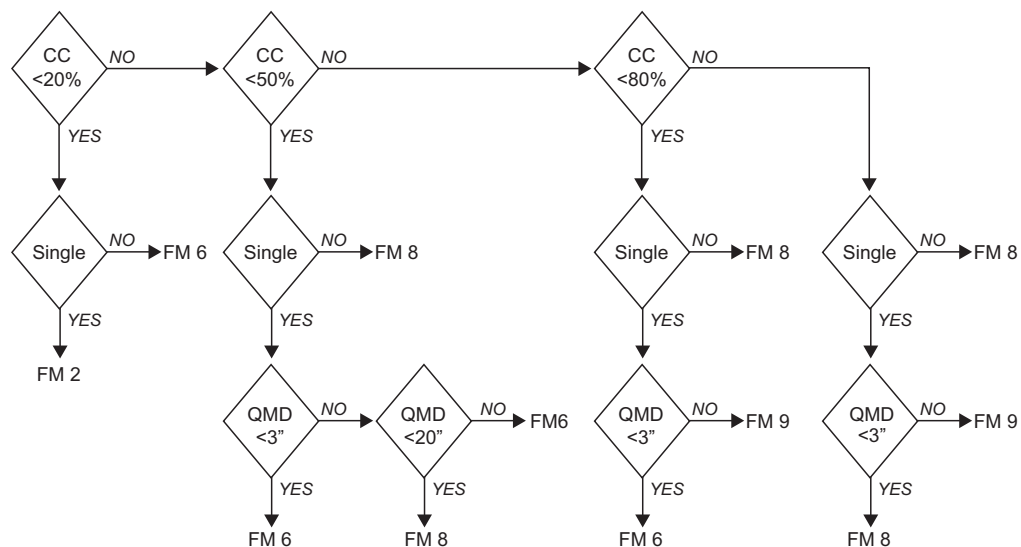

Moist habitat mixture

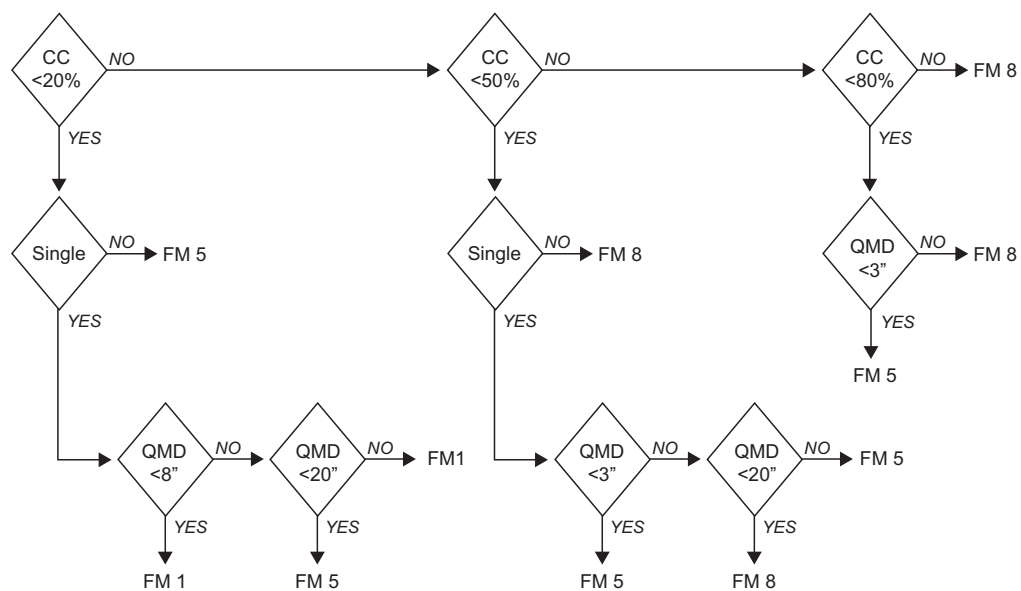

Dry habitat mixture

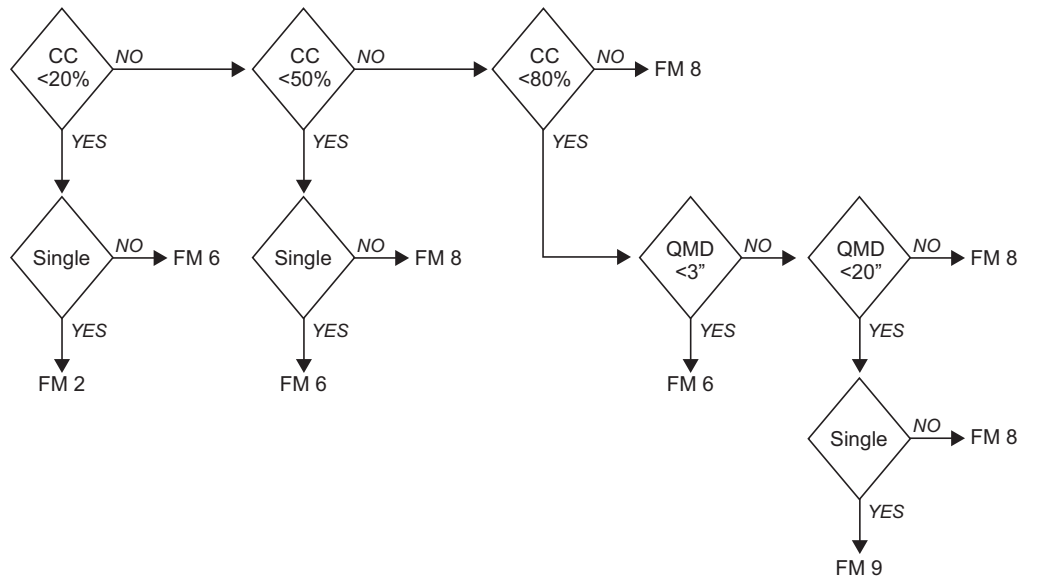

Lodgepole pine, western larch

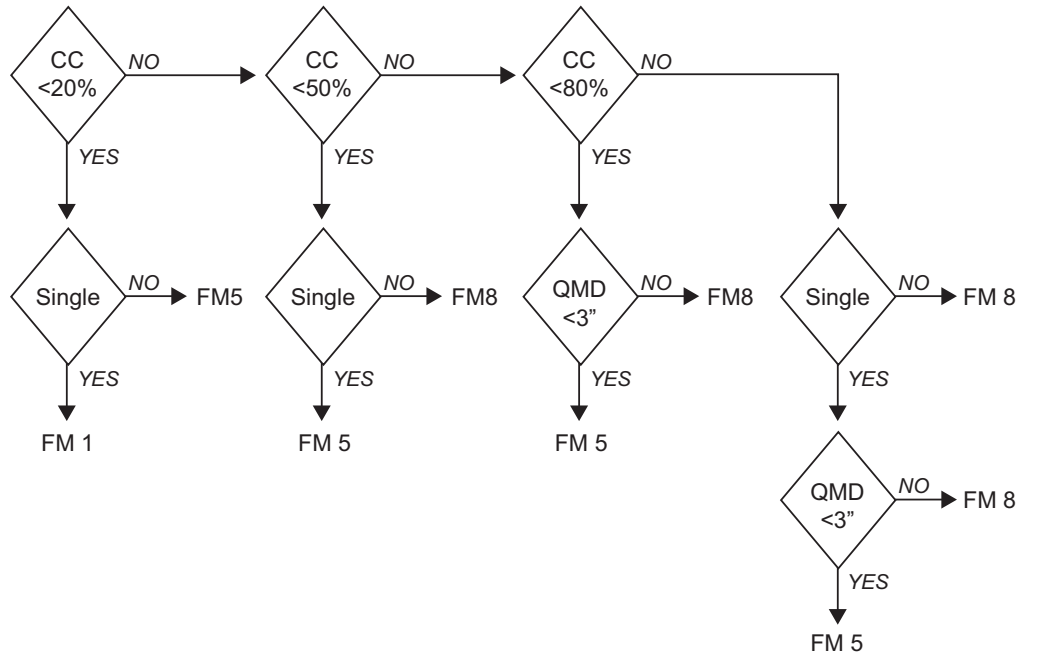

4.9 Central Idaho (CI)

4.9.1 Tree Species

The Central Idaho variant models the 10 tree species shown in table 4.96. One additional category, “other” is modeled using western hemlock.

4.9.2 Snags

The majority of the snag model logic is based on unpublished data provided by Bruce Marcot (USFS, Portland, OR, unpublished data 1995). Snag fall parameters were developed at the FFE design workshop. A complete description of the Snag Submodel is provided in section 2.3 of the FFE “Model Description” chapter.

Four variables are used to modify the Snag Submodel for the different species in the CI-FFE variant:

- A multiplier to modify the species’ fall rate
- A multiplier to modify the time required for snags to decay from a “hard” to “soft” state
- The maximum number of years that snags will remain standing
- A multiplier to modify the species’ height loss rate

These variables are summarized in tables 4.97 and 4.98.

Snag dynamics are similar to the NI-FFE variant, with the following exceptions:

- Western larch, lodgepole pine, Engelmann spruce, subalpine fir and ponderosa pine snags experience no height loss, and their height loss multiplier is set to zero.
- Western white pine and western redcedar lose 75 percent of their original height, after which their height does not change.
- Larch and spruce snags greater than 18 inches dbh fall at a rate that is 32 percent of the rate predicted by Marcot’s equation.

Snag bole volume is determined in using the base FVS model equations. The coefficients shown in table 4.99 are used to convert volume to biomass. Soft snags have 80 percent the density of hard snags.

Table 4.96—Tree species simulated by the Central Idaho variant.

Common name	Scientific name	Notes
western white pine	<i>Pinus monticola</i>	
western larch	<i>Larix occidentalis</i>	
Douglas-fir	<i>Pseudotsuga menziesii</i>	
grand fir	<i>Abies grandis</i>	
western hemlock	<i>Tsuga heterophylla</i>	
western redcedar	<i>Thuja plicata</i>	
lodgepole pine	<i>Pinus contorta</i>	
Engelmann spruce	<i>Picea engelmannii</i>	
subalpine fir	<i>Abies lasiocarpa</i>	
ponderosa pine	<i>Pinus ponderosa</i>	
other		= mountain hemlock

Table 4.97—Default snag fall, snag height loss and soft-snag characteristics for 20 inch DBH snags in the CI-FFE variant. These characteristics are derived directly from the parameter values shown in table 4.98.

Species	95% fallen	All down	50% height	Hard-to-soft
-----Years-----				
western white pine	34	110	76	42
western larch	97 [§]	150	—	42
Douglas-fir	34	75	30	42
grand fir	28	90	20	35
western hemlock	34	150	33	35
western redcedar	103	300	27	35
lodgepole pine	19	35	—	35
Engelmann spruce	81 [§]	100	—	35
subalpine fir	39	40	—	35
ponderosa pine	31	90	—	35
other	34	30	20	35

[§] This value results from using 32% of the default rate for Douglas-fir and spruce snags >18" DBH, as described in the text.

Table 4.98—Default snag fall, snag height loss and soft-snag multipliers for the CI-FFE. These parameters result in the values shown in table 4.97. (These three columns are the default values used by the SNAGFALL, SNAGBRK, and SNAGDCAY keywords, respectively.)

Species	Snag fall	Height loss	Hard-to-soft
western white pine	0.9	0.4	1.1
western larch	1.0 [§]	—	1.1
Douglas-fir	0.9	1.0	1.1
grand fir	1.1	1.5	0.9
western hemlock	0.9	0.9	0.9
western redcedar	0.3	0.3	0.9
lodgepole pine	1.6	—	0.9
Engelmann spruce	1.2 [§]	—	0.9
subalpine fir	0.8	—	0.9
ponderosa pine	0.8	—	0.9
other	0.9	1.5	0.9

[§] This value applies to Douglas-fir and spruce snags <18" DBH; see text for details.

Snag dynamics can be modified by the user using the **SNAGBRK**, **SNAGFALL**, **SNAGDCAY** and **SNAGPBN** keywords described in the FFE “Model Description” chapter.

4.9.3 Fuels

Information on live fuels was developed using FOFEM 4.0 (Reinhardt and others 1997) and FOFEM 5.0 (Reinhardt and others 2001) and in cooperation with Jim Brown (USFS, Missoula, MT pers. comm. 1995). A complete description of the Fuel Submodel is provided in section 2.4 of the FFE “Model Description” chapter.

Table 4.99—Wood density (ovendry lb/ft³) used in the CI-FFE variant.

Species	Density (lb/ft ³)
western white pine	24.8
western larch	34.3
Douglas-fir	31.9
grand fir	24.1
western hemlock	29.5
western redcedar	21.1
lodgepole pine	26.4
Engelmann spruce	22.6
subalpine fir	21.1
ponderosa pine	26.4
other	29.5

Fuels are divided into to four categories: live tree bole, live tree crown, live herb and shrub, and down woody debris (DWD). Live herb and shrub fuel load, and initial DWD are assigned based on the cover species with greatest basal area. If there is no basal area in the first simulation cycle (a “bare ground” stand) then the initial fuel loads are assigned by the vegetation code provided with the **STDINFO** keyword. If the vegetation code is missing or does not identify an overstory species, the model uses a Douglas-fir cover type to assign the default fuels. If there is no basal area in other cycles of the simulation (after a simulated clearcut, for example) herb and shrub fuel biomass is assigned by the previous cover type.

Live Tree Bole: The fuel contribution of live trees is divided into two components: bole and crown. Bole volume is transferred to the FFE after being computed by the FVS model, then converted to biomass using ovendry wood density calculated from table 4-3a and equation 3-5 of *The Wood Handbook* (Forest Products Laboratory 1999). The coefficient in table 4.99 for Douglas-fir is based on Douglas-fir Interior north.

Tree Crown: As described in the section 2.2 of the FFE “Model Description” chapter, equations in Brown and Johnston (1976) provide estimates of live and dead crown material for most species in the CI-FFE (table 4.100).

Table 4.100—The crown biomass equations listed here determine the biomass of foliage, branch, and stem wood. Species mappings are done for species for which equations are not available.

Species	Species mapping and equation source
western white pine	Brown and Johnston (1976)
western larch	Brown and Johnston (1976)
Douglas-fir	Brown and Johnston (1976)
grand fir	Brown and Johnston (1976)
western hemlock	Brown and Johnston (1976)
western redcedar	Brown and Johnston (1976)
lodgepole pine	Brown and Johnston (1976)
Engelmann spruce	Brown and Johnston (1976)
subalpine fir	Brown and Johnston (1976)
ponderosa pine	Brown and Johnston (1976)
other	Gholz (1979); Brown and Johnston (1976)

Mountain hemlock biomass is based on Gholz (1979), using western hemlock equations from Brown and Johnston to partition the biomass and also to provide estimates for trees less than 1 inch diameter.

Live leaf lifespan is used to simulate the contribution of needles and leaves to annual litter fall. Dead foliage and branch materials also contribute to litter fall, at the rates shown in table 4.101. Each year the inverse of the lifespan is added to the litter pool from each biomass category. Leaf lifespan data are from Keane and others (1989). Lifespans of western white pine and mountain hemlock are mapped using ponderosa pine, and western hemlock and western redcedar are based on Douglas-fir.

Live Herbs and Shrubs: Live herb and shrub fuels are modeled simply by the FFE. Shrubs and herbs are assigned a biomass value based on total tree canopy cover and dominant overstory species (table 4.102). When there are no trees, habitat type is used to infer the most likely dominant species of the previous stand (“Model Description” chapter, section 2.4.2). When total tree canopy cover is less than 10 percent, herb and shrub biomass is assigned an “initiating” value (the ‘I’ rows from table 4.102). When canopy cover is greater than 60 percent, biomass is assigned an “established” value (the ‘E’ rows). Live fuel loads are linearly interpolated when canopy cover is between 10 and 60 percent. Data are taken from FOFEM 4.0 (Reinhardt and others 1997) with modifications provided by Jim Brown (USFS, Missoula, MT pers. comm., 1995).

Dead Fuels: Initial default DWD pools are based on overstory species. When there are no trees, habitat type is used to infer the most likely dominant species of the previous stand (“Model Description” chapter, section 2.4.2). Default fuel loadings were provided by Jim Brown (USFS, Missoula, MT pers. comm., 1995) (table 4.103). If tree canopy cover is less than 10 percent, the DWD pools are assigned an “initiating” value, and if cover is greater than 60 percent they are assigned the “established” value. Fuels are linearly interpolated when canopy cover is between 10 and 60 percent. Initial fuel loads can be modified using the **FUELINIT** keyword.

Table 4.101—Life span of live and dead foliage (years) and dead branches for species modeled in the CI-FFE variant.

Species	Live		Dead		
	Foliage	Foliage	<0.25”	0.25–1”	>1”
western white pine	4	2	5	5	15
western larch	1	1	5	5	15
Douglas-fir	5	2	5	5	15
grand fir	7	2	5	5	15
western hemlock	5	2	5	5	15
western redcedar	5	2	5	5	20
lodgepole pine	3	2	5	5	15
Engelmann spruce	6	2	5	5	10
subalpine fir	7	2	5	5	15
ponderosa pine	4	2	5	5	10
other	4	2	5	5	15

Table 4.102—Values (dry weight, tons/acre) for live fuels used in the CI-FFE. Biomass is linearly interpolated between the “initiating” (I) and “established” (E) values when canopy cover is between 10 and 60 percent.

Species		Herbs	Shrubs	Notes
western white pine	E	0.15	0.10	
	I	0.30	2.00	
western larch	E	0.20	0.20	
	I	0.40	2.00	
Douglas-fir	E	0.20	0.20	
	I	0.40	2.00	
grand fir	E	0.15	0.10	
	I	0.30	2.00	
western hemlock	E	0.20	0.20	Use Douglas-fir
	I	0.40	2.00	
western redcedar	E	0.20	0.20	Use Douglas-fir
	I	0.40	2.00	
lodgepole pine	E	0.20	0.10	
	I	0.40	1.00	
Engelmann spruce	E	0.15	0.20	
	I	0.30	2.00	
subalpine fir	E	0.15	0.20	
	I	0.30	2.00	
ponderosa pine	E	0.20	0.25	
	I	0.25	0.10	
other	E	0.15	0.20	Use spruce-subalpine fir
	I	0.30	2.00	

Table 4.103—Canopy cover and cover type are used to assign default down woody debris (tons/acre) by size class for established (E) and initiating (I) stands.

Species		Size class (inches)						Litter	Duff
		< 0.25	0.25 – 1	1 – 3	3 – 6	6 – 12	> 12		
western white pine	E	1.0	1.0	1.6	10.0	10.0	10.0	0.8	30.0
	I	0.6	0.6	0.8	6.0	6.0	6.0	0.4	12.0
western larch	E	0.9	0.9	1.6	3.5	3.5	0.0	0.6	10.0
	I	0.5	0.5	1.0	1.4	1.4	0.0	0.3	5.0
Douglas-fir	E	0.9	0.9	1.6	3.5	3.5	0.0	0.6	10.0
	I	0.5	0.5	1.0	1.4	1.4	0.0	0.3	5.0
grand fir	E	0.7	0.7	3.0	7.0	7.0	0.0	0.6	25.0
	I	0.5	0.5	2.0	2.8	2.8	0.0	0.3	12.0
western hemlock	E	2.2	2.2	5.2	15.0	20.0	15.0	1.0	35.0
	I	1.6	1.6	3.6	6.0	8.0	6.0	0.5	12.0
western redcedar	E	2.2	2.2	5.2	15.0	20.0	15.0	1.0	35.0
	I	1.6	1.6	3.6	6.0	8.0	6.0	0.5	12.0
lodgepole pine	E	0.9	0.9	1.2	7.0	8.0	0.0	0.6	15.0
	I	0.6	0.7	0.8	2.8	3.2	0.0	0.3	7.0
Engelmann spruce	E	1.1	1.1	2.2	10.0	10.0	0.0	0.6	30.0
	I	0.7	0.7	1.6	4.0	4.0	0.0	0.3	12.0
subalpine fir	E	1.1	1.1	2.2	10.0	10.0	0.0	0.6	30.0
	I	0.7	0.7	1.6	4.0	4.0	0.0	0.3	12.0
ponderosa pine	E	0.7	0.7	1.6	2.5	2.5	0.0	1.4	5.0
	I	0.1	0.1	0.2	0.5	0.5	0.0	0.5	0.8
other	E	1.1	1.1	2.2	10.0	10.0	0.0	0.6	30.0
	I	0.7	0.7	1.6	4.0	4.0	0.0	0.3	12.0

4.9.4 Bark Thickness

Bark thickness contributes to predicted tree mortality from simulated fires. The bark thickness multipliers in table 4.104 are used to calculate single bark thickness as described in the “Model Description” chapter, section 2.5.5. The bark thickness equation used in the mortality equation is unrelated to the bark thickness used in the base FVS model. Data are from FOFEM 5.0 (Reinhardt and others 2001).

4.9.5 Decay Rate

Decay of down material is simulated by applying loss rates to biomass in categories based on the original size-class of the branch and bole pieces as described in section 2.4.5 of the “Model Description” chapter. (table 4.105)

Table 4.104—Species specific constants for determining single bark thickness.

Species	Multiplier (V_{sp})
western white pine	0.035
western larch	0.063
Douglas-fir	0.063
grand fir	0.046
western hemlock	0.040
western redcedar	0.035
lodgepole pine	0.028
Engelmann spruce	0.036
subalpine fir	0.041
ponderosa pine	0.063
other	0.040

Table 4.105—Default annual loss rates on mesic sites are applied based on size class. A portion of the loss is added to the duff pool each year. Loss rates are for hard material. If present, soft material in all size classes except litter and duff decays 10 percent faster.

Size class (inches)	Annual loss rate	Proportion of loss becoming duff
< 0.25	0.12	
0.25 — 1		
1 — 3	0.09	
3 — 6		0.02
6 — 12	0.015	
> 12		
Litter	0.50	
Duff	0.002	0.0

Default decay rates on mesic sites are based on Abbott and Crossley (1982). A portion of the loss is added to the duff pool each year. Loss rates are for hard material; soft material in all size classes, except litter and duff, decays 10 percent faster.

Decay rates on moist sites are one-third higher than the rates shown in table 4.105; dry sites are one-third lower. The habitat code set by the **STDINFO** keyword determines whether a stand is defined as a moist, mesic or dry site, as shown in table 4.106. These assignments were provided by Kathy Geier-Hayes (USFS Boise, ID pers. comm., 2001).

The decay rates of species groups may be modified by users, who can provide rates to the four decay classes shown in table 4.107 using the **FUELDCAY** keyword. Users can also reassign species to different classes using the **FUELPOOL** keyword.

4.9.6 Moisture Content

Moisture content of the live and dead fuels is used to calculate fire intensity and fuel consumption (“Model Description” chapter, section 2.5.2). Users can choose from four predefined moisture groups (table 4.108) or they can specify moisture conditions for each class using the **MOISTURE** keyword.

Table 4.106—Habitat type - moisture regime relationships for the CI-FFE variant.

Habitat type code	Regime	Habitat type code	Regime	Habitat type code	Regime	Habitat type code	Regime
50	Dry	330	Dry	525	Mesic	691	Mesic
60	Dry	331	Dry	526	Mesic	692	Mesic
70	Dry	332	Dry	527	Mesic	694	Mesic
80	Dry	334	Dry	580	Dry	700	Mesic
100	Dry	340	Dry	585	Dry	705	Dry
120	Dry	341	Dry	590	Mesic	720	Mesic
130	Dry	343	Dry	591	Mesic	721	Mesic
140	Dry	344	Dry	592	Mesic	723	Mesic
160	Dry	360	Dry	593	Mesic	730	Mesic
161	Dry	370	Dry	600	Mesic	731	Dry
162	Dry	371	Dry	605	Moist	732	Mesic
170	Dry	372	Dry	620	Mesic	734	Mesic
190	Dry	375	Dry	621	Mesic	740	Mesic
195	Dry	380	Dry	625	Mesic	745	Dry
200	Mesic	385	Dry	635	Moist	750	Dry
210	Dry	390	Mesic	636	Moist	780	Dry
220	Dry	392	Dry	637	Moist	790	Dry
221	Dry	393	Mesic	638	Mesic	791	Dry
222	Dry	395	Dry	640	Dry	793	Dry
250	Dry	396	Dry	645	Mesic	810	Mesic
260	Mesic	397	Dry	650	Moist	830	Mesic
262	Mesic	398	Dry	651	Moist	831	Mesic
264	Dry	400	Mesic	652	Moist	833	Mesic
265	Dry	410	Moist	654	Mesic	850	Mesic
280	Mesic	440	Mesic	655	Moist	870	Mesic
290	Mesic	490	Moist	660	Mesic	900	Mesic
310	Dry	493	Dry	661	Mesic	905	Dry
313	Dry	500	Mesic	662	Mesic	920	Dry
315	Dry	505	Dry	663	Mesic	940	Mesic
320	Dry	510	Mesic	670	Mesic	955	Dry
323	Dry	511	Mesic	671	Mesic	999	Mesic
324	Dry	515	Mesic	672	Mesic		
325	Dry	520	Mesic	690	Mesic		

Table 4.107—Default wood decay classes used in the CI-FFE variant. Classes are from *The Wood Handbook* (1999). (1 = exceptionally high; 2 = resistant or very resistant; 3 = moderately resistant, and 4 = slightly or nonresistant.)

Species	Decay class
western white pine	4
western larch	3
Douglas-fir	3
grand fir	4
western hemlock	4
western redcedar	2
lodgepole pine	4
Engelmann spruce	4
subalpine fir	4
ponderosa pine	4
other	4

Table 4.108—Moisture values, which alter fire intensity and consumption, have been predefined for four groups.

Size class	Moisture group			
	Very dry	Dry	Moist	Wet
0 – 0.25 in. (1-hr)	4	8	12	16
0.25 – 1.0 in. (10-hr)	4	8	12	16
1.0 – 3.0 in. (100-hr)	5	10	14	18
> 3.0 in. (1000+ -hr)	10	15	25	50
Duff	15	50	125	200
Live	70	110	150	150

4.9.7 Fire Behavior Fuel Models

Fire behavior fuel models (Anderson 1982) are used to estimate flame length and fire effects stemming from flame length. Fuel models are determined using fuel load and stand attributes (“Model Description” chapter, section 2.4.8) specific to each FFE variant. In addition, stand management actions such as thinning and harvesting can abruptly increase fuel loads and can trigger “Activity Fuels” conditions, resulting in the selection of alternative fuel models. At their discretion, FFE users have the option of:

1. Defining and using their own fuel models
2. Defining the choice of fuel models and weights
3. Allowing the FFE variant to determine a weighted set of fuel models
4. Allowing the FFE variant to determine a weighted set of fuel models, then using the dominant model

This section explains the steps taken by the CI-FFE to follow the third and fourth of these four options.

Fuel Model selection logic is based on one of the 11 Potential Vegetation Groups shown in table 4.109. The CI habitat code is mapped to one of these groups using table 4.110. Site classification information in table 4.110 was

Table 4.109—Fuel model selection in the CI-FFE variant is based in part on classifying each stand into one of 11 site types.

Potential vegetation group	Class
Dry ponderosa pine – xeric Douglas-fir	1
Warm/dry Douglas-fir – moist ponderosa pine	2
Cool moist Douglas-fir	3
Cool dry Douglas-fir	4
Dry grand fir	5
Wet grand fir	6
Warm dry subalpine fir	7
Wet subalpine fir	8
High water table subalpine fir	9
Persistent lodgepole pine	10
High elevation subalpine fir with whitebark pine	11

Table 4.110—Habitat code and corresponding Potential Vegetation Groups (PVG) in the CI-FFE variant.

Habitat code	PVG	Habitat code	PVG	Habitat code	PVG	Habitat code	PVG
50	10	330	2	525	6	691	7
60	10	331	4	526	6	692	10
70	10	332	4	527 [§]	6	694	11
80	10	334	2	580	6	700	7
100	1	340	2	585	6	705	7
120	1	341	4	590	5	720	7
130	1	343	4	591	6	721	7
140	1	344	2	592	6	723	7
160	1	360	4	593	6	730	7
161	1	370	4	600	6	731	7
162	1	371	4	605	7	732	10
170 [§]	2	372	4	620	9	734	11
190 [§]	2	375	4	621	8	740	8
195	1	380	1	625	8	745	10
200	1	385	1	635	8	750	7
210	1	390	3	636	9	780	7
220	1	392	3	637	9	790	10
221	1	393	3	638	9	791	10
222	1	395	4	640	10	793	11
250	3	396	4	645	7	810	11
260 [§]	2	397	4	650	9	830	10
262 [§]	2	398	4	651	9	831	10
264 [§]	2	400	7	652	9	833	11
265 [§]	4	410	7	654	9	850	11
280	3	440	7	655	9	870	11
290	3	490	9	660	8	900	10
310 [§]	2	493	7	661	8	905	10
313 [§]	4	500	5	662	8	920	10
315 [§]	2	505	5	663	10	940	10
320	2	510	6	670	8	955	10
323	4	511		671	8	999	4
324	2	515	6	672	8		
325	4	520	6	690	7		

[§] These habitat codes map to Snowberry/Ninebark, as shown in figure 4.9.2

provided by Kathy Geier-Hayes (Fire Ecologist, USFS Boise, ID pers. comm., 2001).

When the combination of large and small fuel lies in the lower left corner of the graph shown in figure 4.12, one or more low-fuel fuel models become candidate models. In other regions of the graph, other fuel models may also be candidates. The cover types described above, along with the flow diagrams in figure 4.13, define which low fuel model(s) will become candidates. According to the logic of the figure, only a single fuel model will be chosen for a given stand structure. Consequently, as a stand undergoes structural changes due to management or maturation, the selected fire model can jump from one model selection to another, which in turn may cause abrupt changes in predicted fire behavior. To smooth out changes resulting from changes in fuel model, the strict logic is augmented by smooth linear transitions using percent canopy cover.

If the **STATFUEL** keyword is selected, fuel model is determined by using only the closest match fuel model identified by either figure 4.12 or 4.13. The **FLAMEADJ** keyword allows the user to scale the calculated flame length or override the calculated flame length with a value they choose.

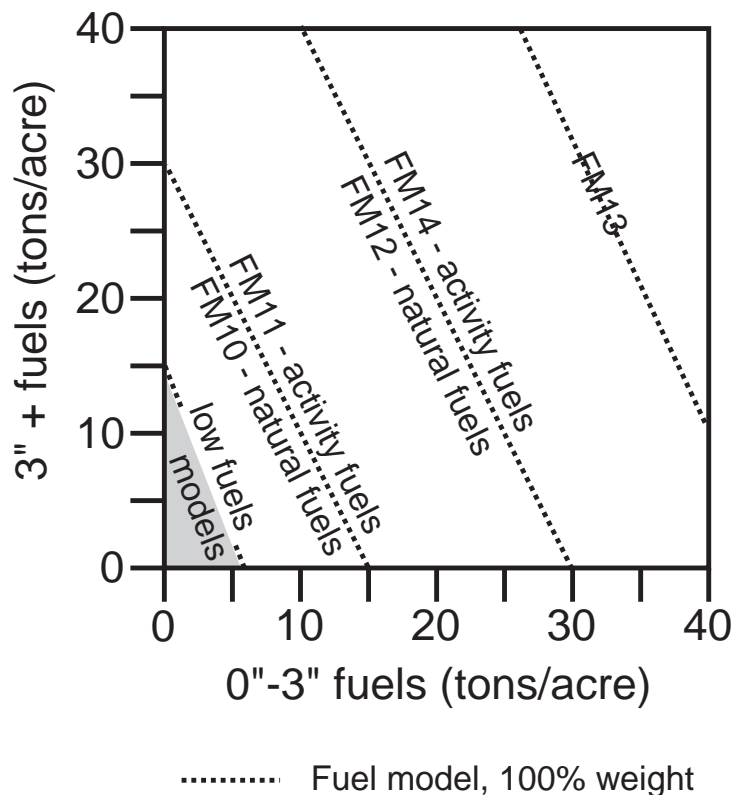

Figure 4.12—If large and small fuels map to the shaded area, candidate fuel models are determined using the logic shown in figure 4.13. Otherwise, flame length is based on the distance to the closest fuel models, identified by the dashed lines, and on recent management (see “Model Description” chapter, section 2.4.8 for further details).

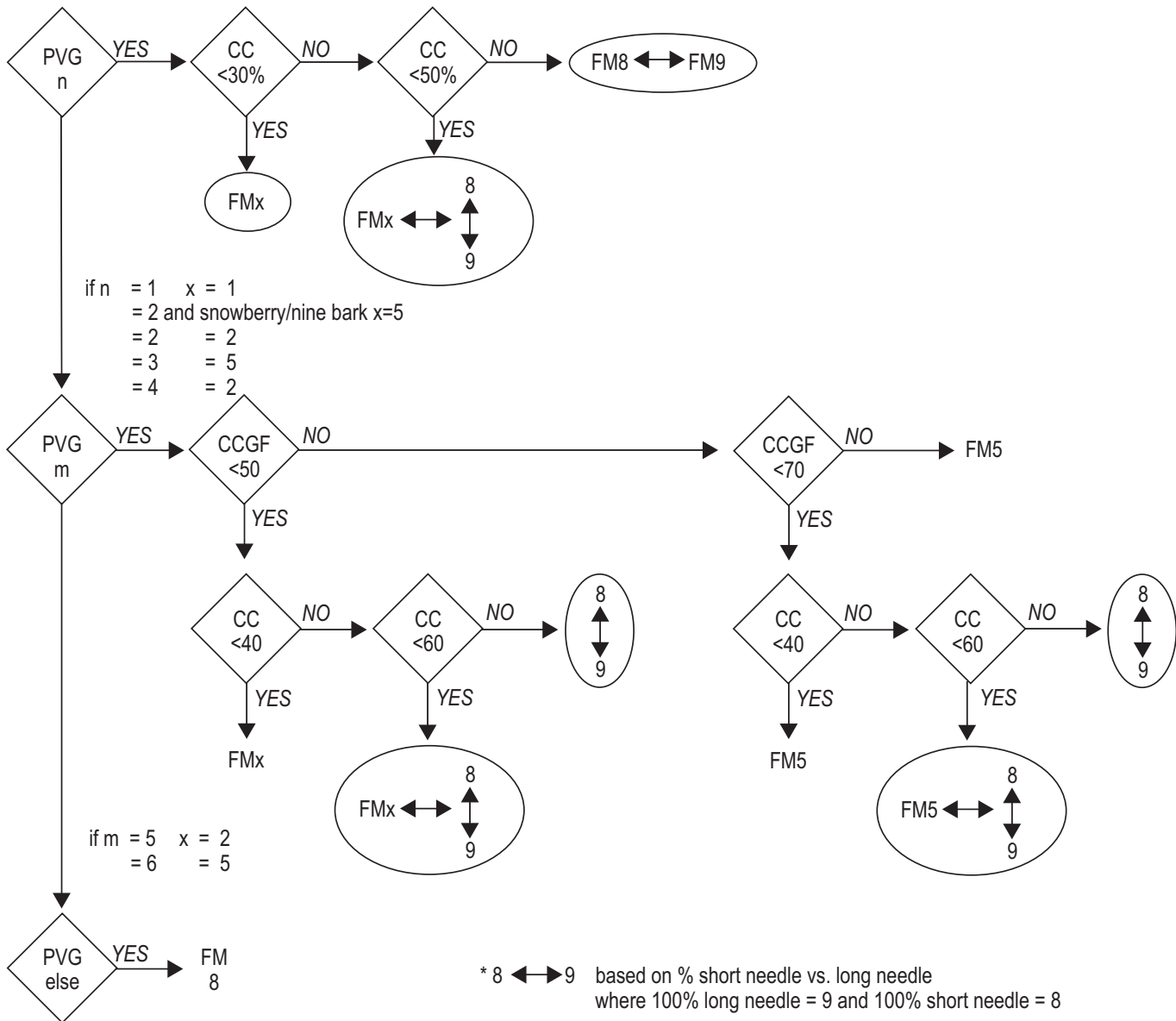

Figure 4.13—Logic for modeling fire at “low” fuel loads in the CI-FFE variant. The ‘n’ and ‘m’ indices are the PVG groups defined in table 4.104.

4.10 Tetons (TT)

4.10.1 Tree Species

The Tetons variant models the seven tree species shown in table 4.111. One additional category, “other” is modeled using whitebark pine to simulate other pines.

4.10.2 Snags

The majority of the snag model logic is based on unpublished data provided by Bruce Marcot (USFS, Portland, OR, unpublished data 1995). Snag fall parameters were developed at the FFE design workshop. A complete description of the Snag Submodel is provided in section 2.3 of the FFE “Model Description” chapter.

Four variables are used to modify the Snag Submodel for the different species in the TT-FFE variant:

- A multiplier to modify the species’ fall rate
- A multiplier to modify the time required for snags to decay from a “hard” to “soft” state
- The maximum number of years that snags will remain standing
- A multiplier to modify the species’ height loss rate

These variables are summarized in tables 4.112 and 4.113.

Table 4.111—Tree species simulated by the Tetons variant.

Common name	Scientific name	Notes
whitebark pine	<i>Pinus albicaulis</i>	
limber pine	<i>Pinus flexilis</i>	
Douglas-fir	<i>Pseudotsuga menziesii</i>	
quaking aspen	<i>Populus tremuloides</i>	
lodgepole pine	<i>Pinus contorta</i>	
Engelmann spruce	<i>Picea engelmannii</i>	
subalpine fir	<i>Abies lasiocarpa</i>	
other		= other pines

Table 4.112—Default snag fall, snag height loss and oft-snag characteristics for 15 inch DBH snags in the TT-FFE variant. These characteristics are derived directly from the parameter values shown in table 4.113.

Species	95% fallen	All down	50% height	Hard-to-soft
	-----Years-----			
whitebark pine	185	90	—	29
limber pine	185	90	—	29
Douglas-fir	94 [¶]	100	30 [§]	36
quaking aspen	32	15	—	29
lodgepole pine	47	50	—	29
Engelmann spruce	124 [¶]	100	—	29
subalpine fir	94	40	—	29
other	185	90	—	29

[§] 95% of original height is lost at 79 years.

Table 4.113—Default snag fall, snag height loss and soft-snag multipliers for the TT-FFE. These parameters result in the values shown in table 4.112. (These three columns are the default values used by the SNAGFALL, SNAGBRK, and SNAGDCAY keywords, respectively.)

Species	Snag fall	Height loss	Hard-to-soft
whitebark pine	0.41	—	0.9
limber pine	0.41	—	0.9
Douglas-fir	0.81 [†]	1.01 [§]	1.1
quaking aspen	2.40	—	0.9
lodgepole pine	1.60	—	0.9
Engelmann spruce	0.61 [†]	—	0.9
subalpine fir	0.81	—	0.9
Other	0.41	—	0.9

[†]This value applies to Douglas-fir and spruce snags <18" DBH; see text for details. [§] height loss coefficient = 4.61 after 50% height loss

Height loss is only significant for Douglas-fir and is set to zero for all other species. After Douglas-fir snags have lost half their original height, the rate of height loss increases markedly, as shown in table 4.112. In the case of Douglas-fir and spruce snags greater than 18 inches DBH, the fall rate is reduced to 32 percent of the rate predicted by Marcot's equation. Finally, the fall rate of aspen is also halved in the 10 years following a burn.

Snag bole volume is determined in using the base FVS model equations. The coefficients shown in table 4.114 are used to convert volume to biomass. Soft snags have 80 percent the density of hard snags.

Snag dynamics can be modified by the user using the **SNAGBRK**, **SNAGFALL**, **SNAGDCAY** and **SNAGPBN** keywords described in the FFE "Model Description" chapter.

4.10.3 Fuels

Information on live fuels was developed using FOFEM 4.0 (Reinhardt and others 1997) and FOFEM 5.0 (Reinhardt and others 2001) and in cooperation with Jim Brown (USFS, Missoula, MT pers. comm. 1995). A complete description of the Fuel Submodel is provided in section 2.4 of the FFE "Model Description" chapter.

Table 4.114—Wood density (ovendry lb/ft³) used in the TT-FFE variant.

Species	Density (lb/ft ³)
whitebark pine	24.8
limber pine	24.8
Douglas-fir	31.9
quaking aspen	24.1
lodgepole pine	26.4
Engelmann spruce	22.6
subalpine fir	21.1
other	24.8

Fuels are divided into to four categories: live tree bole, live tree crown, live herb and shrub, and down woody debris (DWD). Live herb and shrub fuel load, and initial DWD are assigned based on the cover species with greatest basal area. If there is no basal area in the first simulation cycle (a “bare ground” stand) then the initial fuel loads are assigned by the vegetation code provided with the **STDINFO** keyword. If the vegetation code is missing or does not identify an overstory species, the model uses a lodgepole cover type to assign the default fuels. If there is no basal area in other cycles of the simulation (after a simulated clearcut, for example) herb and shrub fuel biomass is assigned by the previous cover type.

Live Tree Bole: The fuel contribution of live trees is divided into two components: bole and crown. Bole volume is transferred to the FFE after being computed by the FVS model, then converted to biomass using oven-dry wood density calculated from table 4-3a and equation 3-5 of The Wood Handbook (Forest Products Laboratory 1999). The coefficient in table 4.114 for Douglas-fir is based on Douglas-fir north.

Tree Crown: As described in the section 2.2 of the FFE “Model Description” chapter, equations in Brown and Johnston (1976) provide estimates of live and dead crown material for most species in the TT-FFE (table 4.115).

Live leaf lifespan is used to simulate the contribution of needles and leaves to annual litter fall. Dead foliage and branch materials also contribute to litter fall, at the rates shown in table 4.116. Each year the inverse of the lifespan is added to the litter pool from each biomass category. Leaf lifespan data are from Keane and others (1989).

Table 4.115—The crown biomass equations listed here determine the biomass of foliage, branch, and stem wood. Species mappings are done for species for which equations are not available.

Species	Species mapping and equation source
whitebark pine	Brown (1978)
limber pine	lodgepole pine: Brown and Johnston (1976)
Douglas-fir	Brown and Johnston (1976)
quaking aspen	Ruark (1987) <1” DBH, Standish and others (1985) >1” DBH
lodgepole pine	Brown and Johnston (1976)
Engelmann spruce	Brown and Johnston (1976)
subalpine fir	Brown and Johnston (1976)
other	whitebark pine; Brown (1978)

Table 4.116—Life span of live and dead foliage (years) and dead branches for species modeled in the TT-FFE variant.

Species	Live	Dead			
	Foliage	Foliage	<0.25”	0.25–1”	>1”
whitebark pine	3	2	5	5	15
limber pine	3	2	5	5	15
Douglas-fir	5	2	5	5	15
quaking aspen	1	1	5	5	10
lodgepole pine	3	2	5	5	15
Engelmann spruce	6	2	5	5	10
subalpine fir	7	2	5	5	15
other	3	2	5	5	15

Live Herbs and Shrubs: Live herb and shrub fuels are modeled simply by the FFE. Shrubs and herbs are assigned a biomass value based on total tree canopy cover and dominant overstory species (table 4.117). When there are no trees, habitat type is used to infer the most likely dominant species of the previous stand (“Model Description” chapter, section 2.4.2). When total tree canopy cover is less than 10 percent, herb and shrub biomass is assigned an “initiating” value (the ‘I’ rows from table 4.117). When canopy cover is greater than 60 percent, biomass is assigned an “established” value (the ‘E’ rows). Live fuel loads are linearly interpolated when canopy cover is between 10 and 60 percent. Data are taken from FOFEM 4.0 (Reinhardt and others 1997) with modifications provided by Jim Brown (USFS, Missoula, MT pers. comm., 1995). Data on pine were developed after examining live fuels reported in the Stereo Photo Guides for Quantifying Natural Fuels (Ottmar and others 2000b).

Dead Fuels: Initial default DWD pools are based on overstory species. When there are no trees, habitat type is used to infer the most likely dominant species of the previous stand (“Model Description” chapter, section 2.4.2). Default fuel loadings were provided by Jim Brown (USFS, Missoula, MT pers. comm., 1995) (table 4.118). If tree canopy cover is less than 10 percent, the DWD pools are assigned an “initiating” value, and if cover is greater than 60 percent they are assigned the “established” value. Fuels are linearly interpolated when canopy cover is between 10 and 60 percent. Initial fuel loads can be modified using the **FUELINIT** keyword.

4.10.4 Bark Thickness

Bark thickness contributes to predicted tree mortality from simulated fires. The bark thickness multipliers in table 4.119 are used to calculate single bark thickness as described in the “Model Description” chapter, section 2.5.5. The bark thickness equation used in the mortality equation is

Table 4.117—Values (dry weight, tons/acre) for live fuels used in the TT-FFE. Biomass is linearly interpolated between the “initiating” (I) and “established” (E) values when canopy cover is between 10 and 60 percent.

Species		Herbs	Shrubs	Notes
whitebark pine	E	0.20	0.10	Use lodgepole pine
	I	0.40	1.00	
limber pine	E	0.20	0.10	Use lodgepole pine
	I	0.40	1.00	
Douglas-fir	E	0.20	0.20	
	I	0.40	2.00	
quaking aspen	E	0.25	0.25	Ottmar and others 2000b
	I	0.18	1.32	
lodgepole pine	E	0.20	0.10	
	I	0.40	1.00	
Engelmann spruce	E	0.15	0.20	
	I	0.30	2.00	
subalpine fir	E	0.15	0.20	
	I	0.30	2.00	
other	E	0.20	0.10	Use whitebark pine
	I	0.40	1.00	

Table 4.118—Canopy cover and cover type are used to assign default dead fuel loads (tons/acre) by size class for established (E) and initiating (I) stands.

Species		Size class (inches)						Litter	Duff
		< 0.25	0.25 – 1	1 – 3	3 – 6	6 – 12	> 12		
whitebark pine	E	0.9	0.9	1.2	7.0	8.0	0.0	0.6	15.0
	I	0.6	0.7	0.8	2.8	3.2	0.0	0.3	7.0
limber pine	E	0.9	0.9	1.2	7.0	8.0	0.0	0.6	15.0
	I	0.6	0.7	0.8	2.8	3.2	0.0	0.3	7.0
Douglas-fir	E	0.9	0.9	1.6	3.5	3.5	0.0	0.6	15.0
	I	0.5	0.5	1.0	1.4	1.4	0.0	0.3	5.0
quaking aspen	E	0.2	0.6	2.4	3.6	5.6	0.0	1.4	16.8
	I	0.1	0.4	5.0	2.2	2.3	0.0	0.8	5.6
lodgepole pine	E	0.9	0.9	1.2	7.0	8.0	0.0	0.6	15.0
	I	0.6	0.7	0.8	2.8	3.2	0.0	0.3	7.0
Engelmann spruce	E	1.1	1.1	2.2	10.0	10.0	0.0	0.6	30.0
	I	0.7	0.7	1.6	4.0	4.0	0.0	0.3	12.0
subalpine fir	E	1.1	1.1	2.2	10.0	10.0	0.0	0.6	30.0
	I	0.7	0.7	1.6	4.0	4.0	0.0	0.3	12.0
other	E	0.9	0.9	1.2	7.0	8.0	0.0	0.6	15.0
	I	0.6	0.7	0.8	2.8	3.2	0.0	0.3	7.0

Table 4.119—Species specific constants for determining single bark thickness.

Species	Multiplier (V_{sp})
whitebark pine	0.030
limber pine	0.030
Douglas-fir	0.063
quaking aspen	0.044
lodgepole pine	0.028
Engelmann spruce	0.036
subalpine fir	0.041
other	0.030

unrelated to the bark thickness used in the base FVS model. Data are from FOFEM 5.0 (Reinhardt and others 2001).

4.10.5 Decay Rate

Decay of down material is simulated by applying loss rates to biomass in categories based on the original size-class of the branch and bole pieces described in section 2.4.5 of the “Model Description” chapter (table 4.120) By default, down material decays at the rate used by the UT-FFE: 55 percent lower than the default decay rates based on Abbott and Crossley (1982). A portion of the loss is added to the duff pool each year. Loss rates are for hard material; soft material in all size classes, except litter and duff, decays 10 percent faster.

By default, the FFE decays all wood species at the rates shown in table 4.120. The decay rates of species groups may be modified by users, who can provide rates to the four decay classes shown in table 4.121 using the **FUELDCA** keyword. Users can also reassign species to different classes using the **FUELPOOL** keyword.

Table 4.120—Default annual loss rates are applied based on size class. A portion of the loss is added to the duff pool each year. Loss rates are for hard material. The rates for woody material are the same as those used by the UT-FFE. If present, soft material in all size classes except litter and duff decays 10 percent faster.

Size class (inches)	Annual loss rate	Proportion of loss becoming duff
< 0.25	0.054	
0.25 — 1		
1 — 3	0.041	
3 — 6		0.02
6 — 12	0.0068	
> 12		
Litter	0.50	
Duff	0.002	0.0

Table 4.121—Default wood decay classes used in the TT-FFE variant. Classes are from *The Wood Handbook* (1999). (1 = exceptionally high; 2 = resistant or very resistant; 3 = moderately resistant, and 4 = slightly or nonresistant.)

Species	Decay class
whitebark pine	4
limber pine	4
Douglas-fir	3
quaking aspen	4
lodgepole pine	4
Engelmann spruce	4
subalpine fir	4
other	4

4.10.6 Moisture Content

Moisture content of the live and dead fuels is used to calculate fire intensity and fuel consumption (Model Description, section 2.5.2). Users can choose from four predefined moisture groups (table 4.122) or they can specify moisture conditions for each class using the **MOISTURE** keyword.

Table 4.122—Moisture values, which alter fire intensity and consumption, have been predefined for four groups. In general they are drier than the default values used in the NI-FFE.

Size class	Moisture group			
	Very dry	Dry	Moist	Wet
0 – 0.25 in. (1-hr)	4	5	8	10
0.25 – 1.0 in. (10-hr)	4	6	10	12
1.0 – 3.0 in. (100-hr)	5	8	12	15
> 3.0 in. (1000+ -hr)	10	15	16	18
Duff	15	50	125	200
Live	70	90	120	140

4.10.7 Fire Behavior Fuel Models

Fire behavior fuel models (Anderson 1982) are used to estimate flame length and fire effects stemming from flame length. Fuel models are determined using fuel load and stand attributes (“Model Description” chapter, section 2.4.8) specific to each FFE variant. In addition, stand management actions such as thinning and harvesting can abruptly increase fuel loads and can trigger “Activity Fuels” conditions, resulting in the selection of alternative fuel models. At their discretion, FFE users have the option of:

1. Defining and using their own fuel models
2. Defining the choice of fuel models and weights
3. Allowing the FFE variant to determine a weighted set of fuel models
4. allowing the FFE variant to determine a weighted set of fuel models, then using the dominant model

This section explains the steps taken by the TT-FFE to follow the third and fourth of these four options.

When the combination of large and small fuel lies in the lower left corner of the graph shown in figure 4.14, one or more low-fuel fuel models become candidate models. In other regions of the graph, other fuel models may also

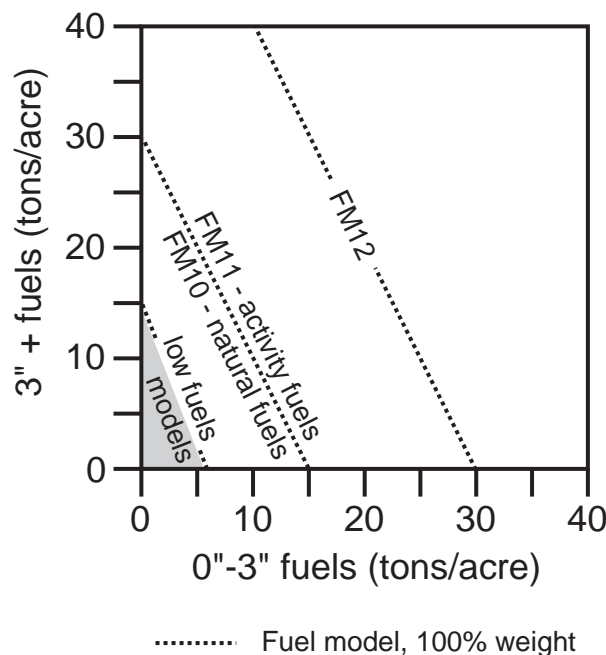

Figure 4.14—If large and small fuels map to the shaded area, candidate fuel models are determined using the logic shown in figure 4.15. Otherwise, flame length is based on the distance to the closest fuel models, identified by the dashed lines, and on recent management (see “Model Description” chapter, section 2.4.8 for further details).

be candidates. The logical flow shown in figure 4.15 defines which low fuel model(s) will become candidates. According to the logic of figure 4.15, only a single fuel model will be chosen for a given stand structure. Consequently, as a stand undergoes structural changes due to management or maturation, the selected fire model can jump from one model selection to another, which in turn may cause abrupt changes in predicted fire behavior. To smooth out changes resulting from changes in fuel model, the strict logic is augmented by linear transitions between states that involve continuous variables (for example, percent canopy cover, average height, snag density, and so forth).

The program logic shown in figure 4.15 also uses stand structure classes in some decision rules. The TT-FFE uses the default structure class rules documented in Crookston and Stage (1999) unless model users alter those definitions using the **STRCLS** keyword.

If the **STATFUEL** keyword is selected, fuel model is determined by using only the closest match fuel model identified by either figure 4.14 or figure 4.15. The **FLAMEADJ** keyword allows the user to scale the calculated flame length or override the calculated flame length with a value they choose.

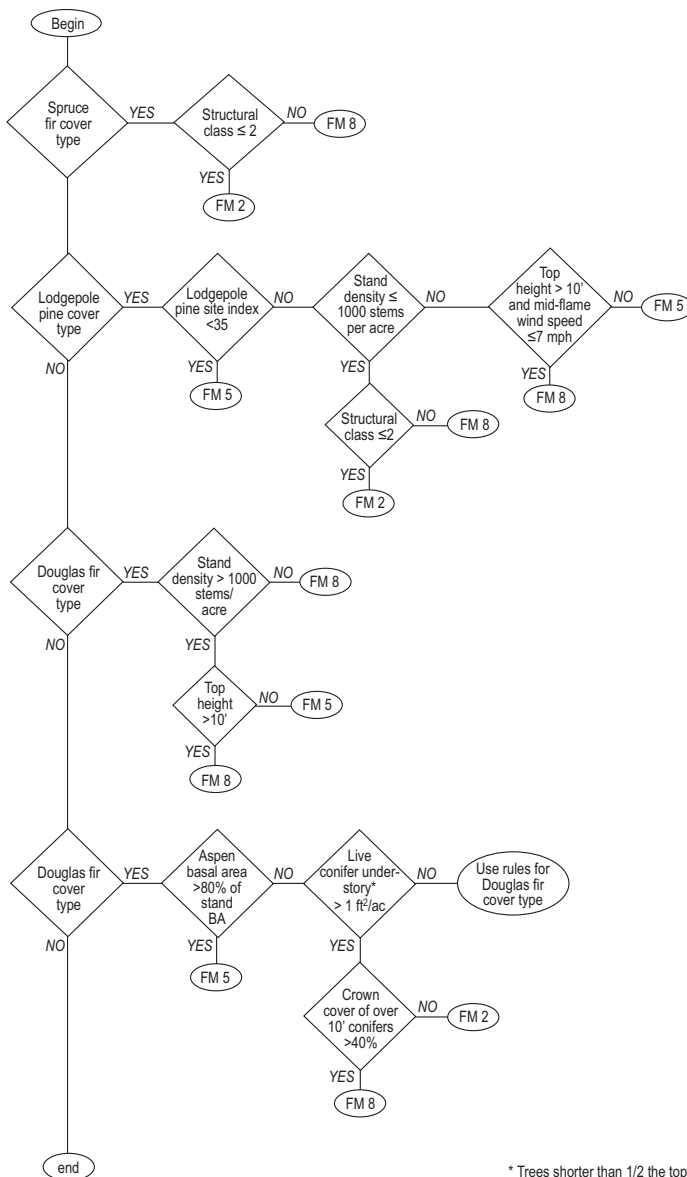

Figure 4.15—Logic for modeling fire at “low” fuel loads in the TT-FFE variant.

* Trees shorter than 1/2 the top height

4.11 Blue Mountains (BM)

4.11.1 Tree Species

The Blue Mountains variant models the nine tree species shown in table 4.123. One additional category, “other” and is modeled using juniper.

4.11.2 Snags

The majority of the snag model logic is based on unpublished data provided by Bruce Marcot (USFS, Portland, OR, unpublished data 1995). Snag fall parameters were developed at the FFE design workshop. A complete description of the Snag Submodel is provided in section 2.3 of the FFE “Model Description” chapter.

Four variables are used to modify the Snag Submodel for the different species in the BM-FFE variant:

- A multiplier to modify the species’ fall rate
- A multiplier to modify the time required for snags to decay from a “hard” to “soft” state
- The maximum number of years that snags will remain standing
- A multiplier to modify the species’ height loss rate

These variables are summarized in tables 4.124 and 4.125.

Snag dynamics are similar to the NI-FFE variant, with the exception that height loss rates for all species increase markedly after half the original height is lost (coefficients not shown here). In addition, the default coefficient for snag height loss is changed from 0.0228 to 0.03406.

Snag bole volume is determined in using the base FVS model equations. The coefficients shown in table 4.126 are used to convert volume to biomass. Soft snags have 80 percent the density of hard snags.

Snag dynamics can be modified by the user using the **SNAGBRK**, **SNAGFALL**, **SNAGDCAY** and **SNAGPBN** keywords described in the FFE “Model Description” chapter.

Table 4.123—Tree species simulated by the Blue Mountains variant.

Common name	Scientific name	Notes
western white pine	<i>Pinus monticola</i>	
western larch	<i>Larix occidentalis</i>	
Douglas-fir	<i>Pseudotsuga menziesii</i>	
grand fir	<i>Abies grandis</i>	
mountain hemlock	<i>Tsuga mertensiana</i>	
lodgepole pine	<i>Pinus contorta</i>	
Engelmann spruce	<i>Picea engelmannii</i>	
subalpine fir	<i>Abies lasiocarpa</i>	
ponderosa pine	<i>Pinus ponderosa</i>	
other		= western juniper

Table 4.124—Default snag fall, snag height loss and soft-snag characteristics for 15 inch DBH snags in the BM-FFE variant. These characteristics are derived directly from the parameter values shown in table 4.125.

Species	95% fallen	All down	50% height	Hard-to-soft
-----Years-----				
western white pine	20	75	30	36
western larch	30	100	55	36
Douglas-fir	30	75	30	36
grand fir	25	60	20	29
mountain hemlock	25	70	20	29
lodgepole pine	20	50	30	29
Engelmann spruce	40	75	30	29
subalpine fir	30	60	25	29
ponderosa pine	20	80	35	32
other	40	100	75	29

Table 4.125—Default snag fall, snag height loss and soft-snag multipliers for the BM-FFE. These parameters result in the values shown in table 4.124. (These three columns are the default values used by the SNAGFALL, SNAGBRK, and SNAGDCAY keywords, respectively.)

Species	Snag fall	Height loss	Hard-to-soft
western white pine	1.21	0.68	1.1
western larch	0.81	0.37	1.1
Douglas-fir	0.81	0.68	1.1
grand fir	0.97	1.02	0.9
mountain hemlock	0.97	1.02	0.9
lodgepole pine	1.21	0.68	0.9
Engelmann spruce	0.61	0.68	0.9
subalpine fir	0.81	0.81	0.9
ponderosa pine	1.21	0.58	1.0
other	0.49	0.27	0.9

Table 4.126—Wood density (ovendry lb/ft³) used in the BM-FFE variant.

Species	Density (lb/ft ³)
western white pine	24.8
western larch	34.3
Douglas-fir	32.7
grand fir	24.1
mountain hemlock	29.5
lodgepole pine	26.4
Engelmann spruce	22.6
subalpine fir	21.1
ponderosa pine	26.4
other	34.9

4.11.3 Fuels

Information on live fuels was developed using FOFEM 4.0 (Reinhardt and others 1997) and FOFEM 5.0 (Reinhardt and others 2001) and in cooperation with Jim Brown (USFS, Missoula, MT pers. comm. 1995). A complete description of the Fuel Submodel is provided in section 2.4 of the FFE “Model Description” chapter.

Fuels are divided into to four categories: live tree bole, live tree crown, live herb and shrub, and down woody debris (DWD). Live herb and shrub fuel load, and initial DWD are assigned based on the cover species with greatest basal area. If there is no basal area in the first simulation cycle (a “bare ground” stand) then the initial fuel loads are assigned by the vegetation code provided with the **STDINFO** keyword. If the vegetation code is missing or does not identify an overstory species, the model uses a Douglas-fir cover type to assign the default fuels. If there is no basal area in other cycles of the simulation (after a simulated clearcut, for example) herb and shrub fuel biomass is assigned by the previous cover type.

Live Tree Bole: The fuel contribution of live trees is divided into two components: bole and crown. Bole volume is transferred to the FFE after being computed by the FVS model, then converted to biomass using oven-dry wood density calculated from table 4-3a and equation 3-5 of The Wood Handbook (Forest Products Laboratory 1999). The coefficient in table 4.126 for Douglas-fir is based on Douglas-fir west.

Tree Crown: As described in the section 2.2 of the FFE” Model Description” chapter, equations in Brown and Johnston (1976) provide estimates of live and dead crown material for most species in the BM-FFE (table 4.127). Mountain hemlock biomass is based on Gholz (1979), using western hemlock equations from Brown and Johnston to partition the biomass and also to provide estimates for trees less than 1 inch diameter. Western juniper (“other”) equations are based on a single-stem form.

Live leaf lifespan is used to simulate the contribution of needles and leaves to annual litter fall. Dead foliage and branch materials also contribute to litter fall, at the rates shown in table 4.128. Each year the inverse of the lifespan is added to the litter pool from each biomass category. Leaf lifespan

Table 4.127—The crown biomass equations listed here determine the biomass of foliage, branch, and stem wood. Species mappings are done for species for which equations are not available.

Species	Species mapping and equation source
western white pine	Brown and Johnston (1976)
western larch	Brown and Johnston (1976)
Douglas-fir	Brown and Johnston (1976)
grand fir	Brown and Johnston (1976)
Mountain hemlock	Gholz (1979); Brown and Johnston (1976)
lodgepole pine	Brown and Johnston (1976)
Engelmann spruce	Brown and Johnston (1976)
subalpine fir	Brown and Johnston (1976)
ponderosa pine	Brown and Johnston (1976)
other	Chojnacky (1992), Grier and others (1992)

Table 4.128—Life span of live and dead foliage (years) and dead branches for species modeled in the BM-FFE variant.

Species	Live	Dead			
	Foliage	Foliage	<0.25”	0.25–1”	>1”
western white pine	4	3	10	15	15
western larch	1	1	10	15	15
Douglas-fir	5	3	10	15	15
grand fir	7	3	10	15	15
mountain hemlock	5	3	10	15	15
lodgepole pine	3	3	10	15	15
Engelmann spruce	6	3	10	10	10
subalpine fir	7	3	10	15	15
ponderosa pine	4	3	10	10	10
other	4	3	10	15	20

data are from Keane and others (1989). Lifespans of western white pine and mountain hemlock are mapped using ponderosa pine, and western hemlock and western redcedar are based on Douglas-fir.

Live Herbs and Shrub: Live herb and shrub fuels are modeled simply by the FFE. Shrubs and herbs are assigned a biomass value based on total tree canopy cover and dominant overstory species (table 4.129). When there are no trees, habitat type is used to infer the most likely dominant species of the previous stand (“Model Description” *chapter*, section 2.4.2). When total

Table 4.129—Values (dry weight, tons/acre) for live fuels used in the BM-FFE. Biomass is linearly interpolated between the “initiating” (I) and “established” (E) values when canopy cover is between 10 and 60 percent.

Species		Herbs	Shrubs	Notes
western white pine	E	0.15	0.10	
	I	0.30	2.00	
western larch	E	0.20	0.20	
	I	0.40	2.00	
Douglas-fir	E	0.20	0.20	
	I	0.40	2.00	
grand fir	E	0.15	0.10	
	I	0.30	2.00	
mountain hemlock	E	0.20	0.20	Use Douglas-fir
	I	0.40	2.00	
lodgepole pine	E	0.20	0.10	
	I	0.40	1.00	
Engelmann spruce	E	0.15	0.20	
	I	0.30	2.00	
subalpine fir	E	0.15	0.20	
	I	0.30	2.00	
ponderosa pine	E	0.20	0.25	
	I	0.25	0.10	
other	E	0.04	0.05	Ottmar and others 2000a
	I	0.13	1.63	

tree canopy cover is *less than* 10 percent, herb and shrub biomass is assigned an “initiating” value (the ‘I’ rows from table 4.129). When canopy cover is *greater than* 60 percent, biomass is assigned an “established” value (the ‘E’ rows). Live fuel loads are linearly interpolated when canopy cover is between 10 and 60 percent. Data are taken from FOFEM 4.0 (Reinhardt and others 1997) with modifications provided by Jim Brown (USFS, Missoula, MT pers. comm., 1995).

Dead Fuels: Initial default DWD pools are based on overstory species. When there are no trees, habitat type is used to infer the most likely dominant species of the previous stand (“Model Description” chapter, section 2.4.2). Default fuel loadings were provided by Jim Brown (USFS, Missoula, MT pers. comm., 1995) (table 4.130). If tree canopy cover is less than 10 percent, the DWD pools are assigned an “initiating” value, and if cover is greater than 60 percent they are assigned the “established” value. Fuels are linearly interpolated when canopy cover is between 10 and 60 percent. Initial fuel loads can be modified using the **FUELINIT** keyword.

4.11.4 Bark Thickness

Bark thickness contributes to predicted tree mortality from simulated fires. The bark thickness multipliers in table 4.131 are used to calculate single bark thickness as described in the “Model Description” chapter, section 2.5.5. The bark thickness equation used in the mortality equation is unrelated to the bark thickness used in the base FVS model. Data are from FOFEM 5.0 (Reinhardt and others 2001).

Table 4.130—Canopy cover and cover type are used to assign default down woody debris (tons/acre) by size class for established (E) and initiating (I) stands.

Species		Size class (inches)						Litter	Duff
		< 0.25	0.25 – 1	1 – 3	3 – 6	6 – 12	> 12		
western white pine	E	1.0	1.0	1.6	10.0	10.0	10.0	0.8	30.0
	I	0.6	0.6	0.8	6.0	6.0	6.0	0.4	12.0
western larch	E	0.9	0.9	1.6	3.5	3.5	0.0	0.6	10.0
	I	0.5	0.5	1.0	1.4	1.4	0.0	0.3	5.0
Douglas-fir	E	0.9	0.9	1.6	3.5	3.5	0.0	0.6	10.0
	I	0.5	0.5	1.0	1.4	1.4	0.0	0.3	5.0
grand fir	E	0.7	0.7	3.0	7.0	7.0	0.0	0.6	25.0
	I	0.5	0.5	2.0	2.8	2.8	0.0	0.3	12.0
western hemlock	E	2.2	2.2	5.2	15.0	20.0	15.0	1.0	35.0
	I	1.6	1.6	3.6	6.0	8.0	6.0	0.5	12.0
lodgepole pine	E	0.9	0.9	1.2	7.0	8.0	0.0	0.6	15.0
	I	0.6	0.7	0.8	2.8	3.2	0.0	0.3	7.0
Engelmann spruce	E	1.1	1.1	2.2	10.0	10.0	0.0	0.6	30.0
	I	0.7	0.7	1.6	4.0	4.0	0.0	0.3	12.0
subalpine fir	E	1.1	1.1	2.2	10.0	10.0	0.0	0.6	30.0
	I	0.7	0.7	1.6	4.0	4.0	0.0	0.3	12.0
ponderosa pine	E	0.7	0.7	1.6	2.5	2.5	0.0	1.4	5.0
	I	0.1	0.1	0.2	0.5	0.5	0.0	0.5	0.8
other	E	0.2	0.8	2.3	1.4	3.0	0.0	9.3	0.0
	I	0.0	0.1	0.0	0.0	0.0	0.0	2.0	0.0

Table 4.131—Species specific constants for determining single bark thickness.

Species	Multiplier (V_{sp})
western white pine	0.035
western larch	0.063
Douglas-fir	0.063
grand fir	0.046
mountain hemlock	0.040
lodgepole pine	0.028
Engelmann spruce	0.036
subalpine fir	0.041
ponderosa pine	0.063
other	0.025

4.11.5 Decay Rate

Decay of down material is simulated by applying loss rates to biomass in categories based on the original size-class of the branch and bole pieces as described in section 2.4.5 of the “Model Description” chapter (table 4.132). Default decay rates are based on Abbott and Crossley (1982). A portion of the loss is added to the duff pool each year. Loss rates are for hard material; soft material in all size classes, except litter and duff, decays 10 percent faster.

Decay rates on moist sites are one-third higher than the rates shown in table 4.132; dry sites are one-third lower. The habitat code set by the **STDINFO** keyword determines whether a stand is defined as a moist, mesic, or dry site, as shown in table 4.133. These assignments were provided by

Table 4.132—Default annual loss rates are applied based on size class. A portion of the loss is added to the duff pool each year. Loss rates are for hard material. If present, soft material in all size classes except litter and duff decays 10 percent faster.

Size class (inches)	Annual loss rate	Proportion of loss becoming duff
< 0.25	0.12	
0.25 — 1		
1 — 3	0.09	
3 — 6		0.02
6 — 12	0.015	
> 12		
Litter	0.65	
Duff	0.002	0.0

Table 4.133—Habitat type - moisture regime relationships for the BM-FFE variant. Moisture classes modify default decay rates, as described in the text.

Habitat code	Regime	Habitat code	Regime	Habitat code	Regime	Habitat code	Regime
CAG111	Dry	CES311	Mesic	CPG111	Dry	CWF312	Mesic
CDG111	Dry	CES314	Mesic	CPG112	Dry	CWF421	Mesic
CDG112	Dry	CES315	Mesic	CPG131	Dry	CWF431	Mesic
CDG121	Dry	CES411	Dry	CPG132	Dry	CWF512	Moist
CDS611	Mesic	CES414	Mesic	CPG221	Dry	CWF611	Moist
CDS622	Dry	CES415	Dry	CPG222	Dry	CWF612	Moist
CDS623	Dry	CLF211	Mesic	CPM111	Dry	CWG111	Dry
CDS624	Dry	CLG211	Dry	CPS131	Dry	CWG112	Dry
CDS634	Dry	CLM112	Mesic	CPS221	Dry	CWG113	Dry
CDS711	Dry	CLM113	Moist	CPS222	Dry	CWG211	Mesic
CDS722	Mesic	CLM114	Moist	CPS226	Dry	CWS211	Mesic
CDS821	Dry	CLM312	Moist	CPS232	Dry	CWS212	Mesic
CEF221	Mesic	CLM313	Mesic	CPS233	Dry	CWS321	Dry
CEF311	Moist	CLM314	Moist	CPS234	Dry	CWS322	Dry
CEF331	Mesic	CLM911	Moist	CPS511	Mesic	CWS412	Mesic
CEM111	Moist	CLS411	Mesic	CPS522	Dry	CWS541	Moist
CEM221	Moist	CLS415	Dry	CPS523	Dry	CWS811	Dry
CEM222	Moist	CLS416	Dry	CPS524	Dry	CWS812	Mesic
CEM311	Moist	CLS511	Mesic	CPS525	Dry	CWS912	Moist
CEM312	Moist	CLS515	Mesic	CWC811	Moist	HQM121	Moist
CES131	Mesic	CMS131	Dry	CWC812	Moist	HQM411	Moist
CES221	Mesic	CMS231	Mesic	CWF311	Mesic	HQS221	Mesic

David Powell (Silviculturist, Umatilla NF, USFS, Pendleton, OR pers. comm. 2001)).

By default, the FFE decays all wood species at the rates shown in table 4.132. The decay rates of species groups may be modified by users, who can provide rates to the four decay classes shown in table 4.134 using the **FUELDCAY** keyword. Users can also reassign species to different classes using the **FUELPOOL** keyword.

Table 4.134—Default wood decay classes used in the BM-FFE variant. Classes are from *The Wood Handbook* (1999). (1 = exceptionally high; 2 = resistant or very resistant; 3 = moderately resistant, and 4 = slightly or nonresistant.)

Species	Decay class
western white pine	4
western larch	3
Douglas-fir	3
grand fir	4
mountain hemlock	4
lodgepole pine	4
Engelmann spruce	4
subalpine fir	4
ponderosa pine	4
other	2

4.11.6 Moisture Content

Moisture content of the live and dead fuels is used to calculate fire intensity and fuel consumption (“Model Description” chapter, section 2.5.2). Users can choose from four predefined moisture groups (table 4.135) or they can specify moisture conditions for each class using the **MOISTURE** keyword.

4.11.7 Fire Behavior Fuel Models

Fire behavior fuel models (Anderson 1982) are used to estimate flame length and fire effects stemming from flame length. Fuel models are determined using fuel load and stand attributes (“Model Description” chapter, section 2.4.8) specific to each FFE variant. In addition, stand management actions such as thinning and harvesting can abruptly increase fuel loads and can trigger “Activity Fuels” conditions, resulting in the selection of alternative fuel models. At their discretion, FFE users have the option of:

1. Defining and using their own fuel models
2. Defining the choice of fuel models and weights
3. Allowing the FFE variant to determine a weighted set of fuel models
4. Allowing the FFE variant to determine a weighted set of fuel models, then using the dominant model

This section explains the steps taken by the BM-FFE to follow the third and fourth of these four options.

The fuel model logic for the BM variant is based on stand classification tables provided by Les Holsapple (USFS, Pendleton, OR pers. comm., 2001).

When the combination of large and small fuel lies in the lower left corner of the graph shown in figure 4.16, one or more low-fuel fuel models become candidate models. In other regions of the graph, other fuel models may also be candidates. The stand classification system shown in table 4.136 and the flow diagrams in figure 4.17 define which low fuel model(s) will become candidates.

Figure 4.17 uses size class, canopy cover of the dominant canopy layer, and canopy cover in the canopy layers, to assign stands to a single fuel model. To implement the logic of table 4.136 and figure 4.17, two additional processing steps are made. The first step uses a simplified and hardwired version of the FVS stand structure logic (Crookston and Stage 1999) to provide estimates of canopy cover in up to two vertical layers of the stand. The second step

Table 4.135—Moisture values, which alter fire intensity and consumption, have been predefined for four groups.

Size class	Moisture group			
	Very dry	Dry	Moist	Wet
0 – 0.25 in. (1-hr)	4	8	12	16
0.25 – 1.0 in. (10-hr)	4	8	12	16
1.0 – 3.0 in. (100-hr)	5	10	14	18
> 3.0 in. (1000+ -hr)	10	15	25	50
Duff	15	50	125	200
Live	70	110	150	150

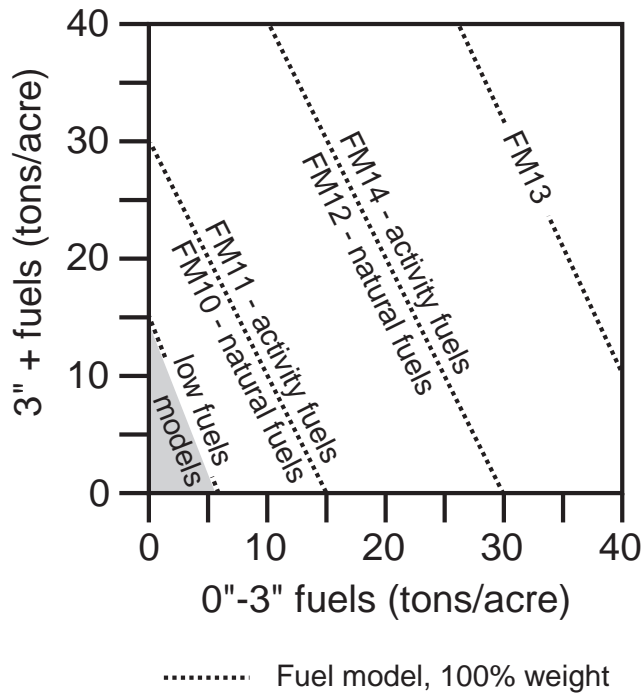

Figure 4.16—If large and small fuels map to the shaded area, candidate fuel models are determined using the logic shown in figure 4.17. Otherwise, flame length is based on the distance to the closest fuel models, identified by the dashed lines, and on recent management (see “Model Description” chapter, section 2.4.8 for further details).

Table 4.136—Size classes used in the BM-FFE fuel model selection logic.

Code	Notes
1	Seedlings; trees less than 1 inch DBH
2	Seedlings and saplings mixed
3	Saplings; trees 1 – 4.9” DBH
4	Saplings and poles mixed
5	Poles; trees 5 – 8.9” mixed
6	Poles and small trees mixed
6.5	Small trees 9 – 14.9” DBH
7	Small trees 9 – 20.9” DBH
7.5	Small trees 15 – 20.9” DBH
8	Small and medium trees mixed
9	Medium trees 21 – 31.9” DBH
10	Medium and large trees mixed
11	Large trees 32 – 47.9” DBH

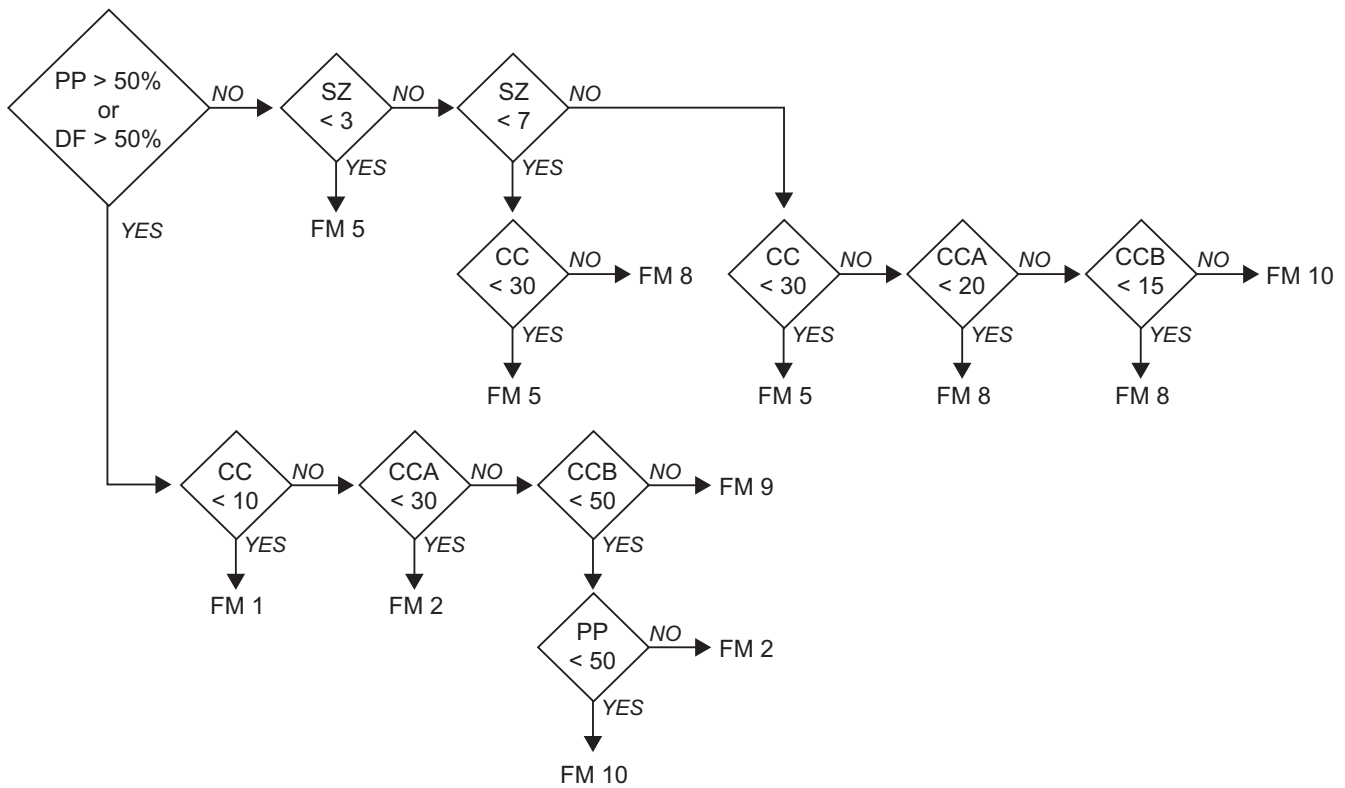

Figure 4.17—Logic for modeling fire at “low” fuel loads in the BM-FFE variant.

begins by classifying the stand into one of the 13 size class codes shown in table 4.136.

As stand structure changes with time or management, the classification of the dominant size class may also change. This can lead to abrupt changes in the fuel model selection. To smooth out these discontinuities, the sample treelist is further processed by repeatedly classifying the stand based on adding a uniform random deviate with a range equal to ± 20 percent of the diameter of each tree. This is repeated 50 times, potentially generating more than one size classification. When the classification weights are taken into the fuel model selection, the fuel model selection varies more smoothly as class boundaries are approached.

Introducing gradual transitions at all the logical breakpoints of the fuel model selection diagram also supports smoother transitions between fuel models. These transitions begin 5 percent below the nominal breakpoint for dominant overstory, percent total canopy cover (CC), percent lower canopy (CCA), and percent upper canopy (CCB).

In the accompanying diagram showing the BM fuel model logic, PP and DF refer to the percentage of stand basal area in ponderosa pine and Douglas-fir, respectively. The size categories referred to in table 4.136 are abbreviated as ‘SZ’.

If the **STATFUEL** keyword is selected, fuel model is determined by using only the closest match fuel model identified by either figure 4.16 or 4.17. The **FLAMEADJ** keyword allows the user to scale the calculated flame length or override the calculated flame length with a value they choose.



References

- Abbott, D.T.; Crossley, D.A. 1982. Woody litter decomposition following clear-cutting. *Ecology* 63(1):35-42.
- Albini, F.A. 1976a. Computer-based models of wildland fire behavior: a user's manual. Ogden UT: U.S. Department of Agriculture, Forest Service, Intermountain Forest and Range Experiment Station. 68 p.
- Albini, F.A. 1976b. Estimating wildfire behavior and effects. Gen. Tech. Rep. INT-30. Ogden, UT: U.S. Department of Agriculture, Forest Service, Intermountain Research Station. 92 p.
- Albini, F.A.; Baughman, R.G. 1979. Estimating windspeeds for predicting wildland fire behavior. Res. Pap. INT-221. Ogden, Utah: U.S. Department of Agriculture, Forest Service, Intermountain Forest and Range Experiment Station. 12 p.
- Anderson, H.E. 1982. Aids to determining fuel models for estimating fire behavior. Gen. Tech. Rep. INT-122. Ogden, UT: U.S. Department of Agriculture, Forest Service, Intermountain Research Station. 22 p.
- Andrews, P.L. 1986. BEHAVE: Fire behavior prediction and fuel modeling system - BURN subsystem, Part 1. Gen. Tech. Rep. INT-194. Ogden, UT: U.S. Department of Agriculture, Forest Service, Intermountain Research Station. 130 p.
- Atkins, David; Lundberg, Renee. 2002. Analyst Hazards When Assessing Fire, Insect and Disease Hazard in Montana Using FIA Data with FVS or Alligators We Didn't See Coming. Pp 83-90 in: Crookston, Nicholas L.; Havis, Robert N. comps. Second Forest Vegetation Simulator (FVS) Conference; February 12-14, 2002, Fort Collins, CO. Proceedings RMRS-P-25. Ogden, UT: U.S. Department of Agriculture, Forest Service, Rocky Mountain Research Station.
- Beukema, Sarah; Greenough, Julee A.; Robinson, Donald C.E.; Kurz, Werner A.; Reinhardt, Elizabeth D.; Crookston, Nicholas L.; Brown, James K.; Hardy, Colin C.; Stage, Albert R. 1999. An introduction to the Fire and Fuels Extension to FVS. In: Teck, Richard; Moeur, Melinda; Adams, Judy, comps. Proceedings: Forest Vegetation Simulator conference; 1977 February 3-7; Fort Collins, CO. Gen. Tech. Rep. INT-GTR-373. Ogden, UT: U.S. Department of Agriculture, Forest Service, Intermountain Research Station. 222 p.
- Beukema, S.J.; Reinhardt, E.D.; Kurz, Werner A.; Crookston, Nicholas L. 2000. An overview of the Fire and Fuels Extension to the Forest Vegetation Simulator. . In: Neuenschwander L.F. and Ryan, K.C. (tech. eds.). Proceedings from: The Joint Fire Science Conference and Workshop – “Crossing the Millennium: Integrating Spatial Technologies and Ecological Principles for a New Age in Fire Management.” The Grove Hotel, Boise, ID, June 15-17, 1999. Volume II. University of Idaho and the International Association of Wildland Fire. pp. 80-85.
- Brown, J.K. 1978. Weight and density of crowns of Rocky Mountain conifers. Gen. Tech. Rep. INT-197. Ogden, UT: U.S. Department of Agriculture, Forest Service, Intermountain Forest and Range Experiment Station. 32 p. + appendices.
- Brown, J.K.; Johnston, C.M. 1976. Debris Prediction System. Ogden, UT: U.S. Department of Agriculture, Forest Service, Intermountain Forest and Range Experiment Station, Fuel Science RWU 2104. 28 p.
- Brown, J.K.; Marsden, M.A.; Ryan, K.C.; Reinhardt, E.D. 1985. Predicting duff and woody fuel consumed by prescribed fire in the northern Rocky Mountains. Res. Pap. INT-337. Ogden, UT: U.S. Department of Agriculture, Forest Service, Intermountain Forest and Range Experiment Station. 23 p.
- Brown, J.K.; Snell, J.A.K.; Bunnell, D.L. 1977. Handbook for Predicting Slash Weight of Western Conifers. Gen. Tech. Rep. INT-37. Ogden, UT: U.S. Department of Agriculture, Forest Service, Intermountain Forest and Range Experiment Station.
- Brown, P.M.; Shepperd, W.D.; Mata, S.A.; McClain, D.L. 1998. Longevity of windthrown logs in a subalpine forest of central Colorado. *Can. J. For. Res.* 28:932-936.

- Chojnacky, D.C. 1992. Estimating volume and biomass for dryland oak species. In: Ffolliott, P.F., Gottfried, G.J., Bennett, D.A., Hernandez, C. V.-M., Ortega-Rubio, A. and R.H. Hamre, technical coordinators. Ecology and management of oak and associated woodlands: perspectives in the southwestern United States and northern Mexico: Proceedings; 1992 April 27-30; Sierra Vista, Arizona. Gen. Tech. Rep. RM-218. Fort Collins, CO: U.S. Department of Agriculture, Forest Service, Rocky Mountain Forest and Range Experiment Station. pp. 155-161.
- Christensen, Glenn; Fight, Roger; Barbour, R. James. 2002. A method to simulate fire hazard reduction treatments using readily available tools. Pp 91-96 in: Crookston, Nicholas L.; Havis, Robert N. comps. Second Forest Vegetation Simulator (FVS) Conference; February 12-14, 2002, Fort Collins, CO. Proceedings RMRS-P-25. Ogden, UT: U.S. Department of Agriculture, Forest Service, Rocky Mountain Research Station.
- Cooper, S.V.; Nieman, K.E.; Roberts, D.W. 1991. Forest habitat types of northern Idaho: a second approximation. Gen. Tech. Rep. INT-236. Ogden, UT: U.S. Department of Agriculture, Forest Service, Intermountain Research Station. 143 p.
- Crookston, N.L.; Stage, A.R. 1999. Percent canopy cover and stand structure statistics from the forest vegetation simulator. Gen. Tech. Rep. RMRS-GTR-24. Ogden, UT: U.S. Department of Agriculture, Forest Service, Rocky Mountain Research Station. 11 p.
- Crookston, Nicholas L. 1990. User's guide to the event monitor: Part of prognosis model version 6. Gen. Tech. Rep. INT-275. Ogden, UT: U.S. Department of Agriculture, Forest Service, Intermountain Research Station. 21 p.
- Crookston, Nicholas L. 1997. Suppose: An Interface to the Forest Vegetation Simulator. In: Teck, Richard; Moeur, Melinda; Adams, Judy. 1997. Proceeding: Forest vegetation simulator conference. 1997 February 3-7, Fort Collins, Co. Gen. Tech. Rep. INT-GTR-373. Ogden, UT: U.S. Department of Agriculture, Forest Service, Intermountain Research Station.
- Crookston, Nicholas L.; Kurz, Werner A.; Beukema, Sarah J.; Reinhardt, Elizabeth D. 2000. Relationships between models used to analyze fire and fuel management alternatives. In: Neuenschwander L.F. and Ryan, K.C. (tech. eds.). Proceedings from: The Joint Fire Science Conference and Workshop – "Crossing the Millennium: Integrating Spatial Technologies and Ecological Principles for a New Age in Fire Management". The Grove Hotel, Boise, ID, June 15-17, 1999. Volume II. University of Idaho and the International Association of Wildland Fire. pp. 103-108.
- Crookston, Nicholas L.; Stage, Albert R. 1991. User's Guide to the Parallel Processing Extension of the Prognosis Model. Gen. Tech. Rep.-INT-281. Ogden, UT: U.S. Department of Agriculture, Forest Service, Intermountain Research Station. 93 p.
- Crookston, Nicholas L.; Stage, Albert R. 1999. Percent canopy cover and stand structure statistics from the Forest Vegetation Simulator. Gen. Tech. Rep. RMRS-GTR-24. Ogden, UT: U.S. Department of Agriculture, Forest Service, Rocky Mountain Research Station. 11 p.
- Division of Forest Economics. 1961. Intermountain Station integrated forest management inventory survey field handbook. Ogden, UT: Intermountain Forest and Range Experiment Station. 61 p.
- Finney, Mark A. 1998. FARSITE: Fire area simulator—Model development and evaluation. Research Paper RMRS-RP-4. Ogden, UT: U.S. Department of Agriculture, Forest Service, Rocky Mountain Research Station. 47 p.
- Forest Products Laboratory. 1999. Wood handbook – Wood as an engineering material. Gen. Tech. Rep. FPL-GTR-113. Madison, WI: U.S. Department of Agriculture, Forest Service, Forest Products Laboratory. 463 p. [Online] Available: <http://www.fpl.fs.fed.us/documnts/FPLGTR/fplgtr113/fplgtr113.htm>
- Frankel, Susan J., technical coordinator. 1998. User's guide to the western root disease model, version 3.0. Gen. Tech. Rep. PSW-GTR-165. Albany, CA: U.S. Department of Agriculture, Forest Service, Pacific Southwest Research Station. 164 p.
- Gholz, H. L., C. C. Grier, A. G. Campbell, and A. T. Brown. 1979. Equations for estimating biomass and leaf area of plants in the pacific northwest. Res. Pap. 41. Corvallis, OR: Oregon State University, School of Forestry, Forest Research Lab.
- Greenough, Julee A.; Robinson, Donald C.E.; Kurz, Werner A.; Beukema, Sarah J.; Densmore, Nancy; Winter, Ralph; Snowdon, Barry. 1999. Use of the Prognosis EI Model in balancing timber and environmental values at the watershed-level. Vancouver BC: ESSA Technologies Ltd. 30 pp. Available: http://www.essa.com/forestry/prognosis_ei/index.html
- Grier, C.C.; Elliott, K.J.; McCullough, D.G. 1992. Biomass distribution and productivity of *Pinus edulis-Juniperus monosperma* woodlands of north-central Arizona. For. Ecol. Mgmt. 50:331-350.
- Hayes, J. L.; Ager, A.A.; Barbour, R. J., tech. eds. In review. Methods for integrated modeling of landscape change: Interior Northwest Landscape Analysis System. Draft Gen. Tech. Rep. Portland, OR: U.S. Department of Agriculture, Forest Service, Pacific Northwest Research Station.
- IPNF. 1999. Fuels and Fire Behavior. In Chapter III, pp. 219-235, Douglas-fir Beetle Project Final Environmental Impact Statement. Coeur d'Alene, ID: U.S. Department of Agriculture, Forest Service, Idaho Panhandle National Forests. Available: http://www.fs.fed.us/outernet/ipnf/eco/projects/dbugs/feis/feis_docs/f_ch3_cda_fire.pdf
- IPNF. 2001. Little Ucelly Heli Bug Environmental Assessment. Coeur d'Alene, ID: U.S. Department of Agriculture, Forest Service, Idaho Panhandle National Forests. Available: <http://www.fs.fed.us/ipnf/eco/manage/nepa/cdanepa/lucelly.pdf>
- Keane, R.E.; Arno, S.F.; Brown, J.K. 1989. FIRESUM—an ecological process model for fire succession in western conifer forests. Gen. Tech. Rep. INT-266. Ogden, UT: U.S. Department of Agriculture, Forest Service, Intermountain Research Station. 76 p.
- Kurz, Werner A.; Beukema, Sarah J. 1999. Decision support needs of JFSP stakeholders and the role of the fire and fuel extension to FVS. Draft report prepared by ESSA Technologies Ltd., Vancouver, B.C. 57 p.
- Mayer, K.E.; Laudenslayer, W.F. Jr. (eds.). 1988. A Guide to Wildlife Habitats of California. California Department of Forestry and Fire Protection, Sacramento, CA. 166 p.

- McGaughey, Robert J. 1997. Visualizing forest and stand dynamics using the stand visualization system. Proc. 1997 ACSM/ASPRS Annual Convention and Exposition. Bethesda, MD: American Society for Photogrammetry and Remote Sensing.
- Moeur, M. 1981. Crown width and foliage weight of Northern Rocky Mountain conifers. Res. Pap. INT-283. Ogden, UT: U.S. Department of Agriculture, Forest Service, Intermountain Forest and Range Experiment Station. Res. Pap. INT-283. 14 p.
- O'Hara, K.L.; Latham, P.A.; Hessburg, P.; Smith, B.G. 1996. A structural classification for Northwest forest vegetation. *Western J. Applied Forestry*. 11(3): 97-102.
- Ottmar, R.D.; Alvarado, E.; Vihnanek, R.E. 1996. Fuel condition classes. Internal report on file with: Pacific Northwest Research Station, Seattle Forestry Sciences Laboratory, 4043 Roosevelt Way N.E., Seattle, WA 98105.
- Ottmar, R.D.; Burns, M.F.; Hall, J.N.; Hanson, A.D. 1993. CONSUME user's guide. Gen. Tech. Rep. PNW-304. Portland, OR: U.S. Department of Agriculture, Forest Service, Pacific Northwest Research Station. 118 p.
- Ottmar, R.D.; Vihnanek, R.E.; Regelbrugge, J.C.. 2000a. Stereo photo series for quantifying natural fuels. Volume IV: pinyon-juniper, sagebrush, and chaparral types in the Southwestern United States. PMS 833. Boise, ID: National Wildfire Coordinating Group, National Interagency Fire Center. 97 p.
- Ottmar, R.D.; Vihnanek, R.E.; Wright, C.S. 2000b. Stereo photo series for quantifying natural fuels. Volume III: Lodgepole pine, quaking aspen, and gambel oak types in the Rocky Mountains. PMS 832. Boise, ID: National Wildfire Coordinating Group, National Interagency Fire Center. 85 p.
- Ottmar, R.D.; Vihnanek, R.E.; Wright, C.S. 1998. Stereo photo series for quantifying natural fuels. Volume I: mixed-conifer with mortality, western juniper, sagebrush, and grassland types in the interior Pacific Northwest. PMS 830 / NFES 2580. Boise, ID: National Wildfire Coordinating Group, National Interagency Fire Center. 73 p.
- Pfister, R.D.; Kovalchik, B.L.; Arno, S.F.; Presby, R.D. 1977. Forest habitat types of Montana. Gen. Tech. Rep. INT-34. Ogden, UT: U.S. Department of Agriculture, Forest Service, Intermountain Forest and Range Experiment Station. 174 p.
- Reinhardt, E.D. 2003, March 16 – last update. FOFEM 5.0 Homepage [Online]. Available: <http://www.fire.org/cgi-bin/nav.cgi?pages=fofem&mode=1> [Online].
- Reinhardt, E.D.; Keane, R.E.; Brown, J.K. 1997. First Order Fire Effects Model: FOFEM 4.0, user's guide. Gen. Tech. Rep. INT-GTR-344. Ogden, UT: U.S. Department of Agriculture, Forest Service, Intermountain Research Station. 65 p.
- Rothermel, R.C. 1972. A mathematical model for predicting fire spread in wildlands fuels. Res. Pap. INT-115. Ogden, UT: U.S. Department of Agriculture, Forest Service, Intermountain Research Station. 40 p.
- Ruark, G.A. 1987. Estimating crown biomass of shade tolerant and intolerant tree species with a variable allometric ratio. In: Ek, Alan R.; Shifley, Stephen R.; Burk Thomas E., eds. Forest growth modelling and prediction: proceedings of the IUFRO conference; 1987 August 23-27; Minneapolis, MN. Society of American Foresters Publication No. 87.12. Gen. Tech. Rep. NC-120. St. Paul, MN: Department of Agriculture, Forest Service, North Central Forest Experiment Station.
- Ryan, K.C.; Reinhardt, E.D. 1988. Predicting postfire mortality of seven western conifers. *Can. J. Forest Res.* 18: 1291-1297.
- Scott, J.H. 2001. Nexus: Fire Behavior and Hazard Assessment System: User's Guide. Unpublished document available at fire.org.
- Scott, J.H.; Reinhardt, E.D. 2001. Assessing crown fire potential by linking models of surface and crown fire behavior. Res. Pap. RMRS-RP-29. Fort Collins, CO: U.S. Department of Agriculture, Forest Service, Rocky Mountain Research Station. 59 p.
- Snell, J.A.K. 1979. Preliminary crown weight estimates for tanoak, black oak and Pacific madrone. Res. Note PNW-340. Portland, OR: U.S. Department of Agriculture, Forest Service, Pacific Northwest Research Station. 4 p.
- Snell, J.A.K.; Little, S.N. 1983. Predicting crown weight and bole volume of five western hardwoods. Gen. Tech. Rep. PNW-151. Portland, OR: U.S. Department of Agriculture, Forest Service, Pacific Northwest Research Station.. 37 p.
- Stage, Albert R. 1973. Prognosis model for stand development. Res. Pap. INT-137. Ogden, UT: U.S. Department of Agriculture, Forest Service, Intermountain Forest and Range Experiment Station. 32 p.
- Standish, J.T.; Manning, G.H.; Demaerschalk, J.P. 1985. Development of biomass equations for British Columbia tree species. Information Report BC-X-264. Canadian Forestry Service, Pacific Forest Research Centre. 48 p.
- Thomas, Jack Ward; Black, Hugh, Jr.; Scherzinger, Richard J.; Pedersen, Richard J. 1979. Deer and Elk. Chapter 8, pp 104-127 In: Thomas, Jack Ward. Wildlife habitats in managed forests of the Blue Mountains of Oregon and Washington. Agriculture Handbook No. 553. Washington DC: U.S. Department of Agriculture, Forest Service. 512 p.
- Van Wagner, C.E. 1973. Height of crown scorch in forest fires. *Can. J. For. Res.* 3:373-378.
- Van Wagner, C.E. 1977. Conditions for the start and spread of crown fire. *Can. J. For. Res.* 7:23-34.
- Williams, C.K.; Kelly, B.; Smith, B.; Lillybridge, T. 1995. Forested plant associations of the Colville National Forest. Gen. Tech. Rep. PNW-GTR-360. Portland, OR: U.S. Department of Agriculture, Forest Service, Pacific Northwest Research Station. 375 p.
- Williams, C.K.; Lillybridge, T.R. 1983. Forested plant associations of the Okanogan National Forest. Report R6-Ecol-132b-1983. Portland, OR: U.S. Department of Agriculture, Forest Service, Pacific Northwest Region. 116 p.
- Williams, C.K.; Lillybridge, T.R.; Smith, B.G. 1990. Forested Plant Associations of the Colville National Forest. Colville, WA: U.S. Department of Agriculture, Forest Service, Colville National Forest. 133 p.
- Wykoff, W.R.; Crookston, N.L.; Stage, A.R. 1982. User's guide to the Stand Prognosis Model. Gen. Tech. Rep. INT-133. Ogden, UT: U.S. Department of Agriculture, Forest Service, Intermountain Forest and Range Experiment Station. 112 p.



Keyword Index

Keyword	Note	Page numbers		
		<i>Chapter 2 Model Description</i>	<i>Chapter 3 User's Guide</i>	<i>Chapter 4 Variants</i>
BURNREPT		55	86, 87	
CRBASEHT	Event Monitor variable		90	
CRBULKDN	Event Monitor variable		90	
CROWNIDX	Event Monitor variable		90	
DEFULMOD		35	71, 72, 73, 74	
DROUGHT			66, 71	
DUFFPROD		32	79	
END			62	
FIRE	Event Monitor variable		89	
FIREYEAR	Event Monitor variable		89	
FLAMEADJ		48, 49	66, 67, 68, 69, 91	102, 111, 123, 137, 147, 158, 168, 183
FMIN			62, 73, 91	
FUELDCAY		32	78, 79	100, 109, 122, 135, 145, 154, 165, 180, 189, 199

Keyword	Note	Page numbers		
		<i>Chapter 2 Model Description</i>	<i>Chapter 3 User's Guide</i>	<i>Chapter 4 Variants</i>
FUELINIT		26	64, 78	99, 107, 119, 134, 143, 153, 163, 177, 188, 197
FUELLOAD	Event Monitor function		89	
FUELMODL		38	71, 72, 73, 74	
FUELMOVE		40	81, 83, 84, 85, 86	
FUELMULT		32	78, 79, 80	
FUELOUT		40	80, 86, 87	
FUELPOOL		27	79, 80	100, 109, 122, 135, 145, 154, 165, 180, 189, 199
FUELREPT		56	86, 87	
FUELTRET		40	81, 83, 84	
MINSOIL	Event Monitor variable		89	
MOISTURE		44	66, 67, 69, 78	100, 109, 122, 135, 145, 154, 166, 180, 190, 200
MORTCLAS			86, 87	
MORTREPT		56	86, 87	
PILEBURN		46, 47	68, 78, 81, 83, 91	
POTFIRE		53, 57	62, 69, 74, 86, 87	
POTFLEN	Event Monitor function		90	
POTFMOIS		53	70	
POTFTEMP		53	70	
POTFWIND		48, 53	70	
PRUNE	Base Model keyword		81, 82	
SALVAGE		21	81, 82, 83	
SIMFIRE		44, 46, 48	66, 67, 68, 69, 73, 78	95, 105, 128, 139, 161, 175, 186, 193
SNAGBRK		17	74, 75	
SNAGCLAS		23, 24	86, 87	
SNAGDCAY		18	75, 76	95, 105, 128, 139, 161, 175, 186, 193

Keyword	Note	Page numbers		
		<i>Chapter 2 Model Description</i>	<i>Chapter 3 User's Guide</i>	<i>Chapter 4 Variants</i>
SNAGFALL		20	76, 77	95, 105, 128, 139, 161, 175, 186, 193
SNAGINIT		15	64, 65, 76	149
SNAGOUT		21	86, 88	
SNAGPBN		20	77, 78	95, 105, 128, 139, 161, 175, 186, 193
SNAGPSFT		15	64, 74, 75, 76	
SNAGS	Event Monitor function		90	
SNAGSUM		23	86, 87	
STATFUEL		38	71, 74	102, 111, 123, 137, 147, 168, 183
SVIMAGES			88	
TORCHIDX	Event Monitor variable		90	
YARDLOSS	Base Model keyword	21, 31	78, 81, 82, 83	



The Rocky Mountain Research Station develops scientific information and technology to improve management, protection, and use of the forests and rangelands. Research is designed to meet the needs of National Forest managers, Federal and State agencies, public and private organizations, academic institutions, industry, and individuals.

Studies accelerate solutions to problems involving ecosystems, range, forests, water, recreation, fire, resource inventory, land reclamation, community sustainability, forest engineering technology, multiple use economics, wildlife and fish habitat, and forest insects and diseases. Studies are conducted cooperatively, and applications may be found worldwide.

Research Locations

Flagstaff, Arizona
Fort Collins, Colorado*
Boise, Idaho
Moscow, Idaho
Bozeman, Montana
Missoula, Montana
Lincoln, Nebraska

Reno, Nevada
Albuquerque, New Mexico
Rapid City, South Dakota
Logan, Utah
Ogden, Utah
Provo, Utah
Laramie, Wyoming

*Station Headquarters, Natural Resources Research Center,
2150 Centre Avenue, Building A, Fort Collins, CO 80526

The U.S. Department of Agriculture (USDA) prohibits discrimination in all its programs and activities on the basis of race, color, national origin, sex, religion, age, disability, political beliefs, sexual orientation, or marital or family status. (Not all prohibited bases apply to all programs.) Persons with disabilities who require alternative means for communication of program information (Braille, large print, audiotape, etc.) should contact USDA's TARGET Center at (202) 720-2600 (voice and TDD).

To file a complaint of discrimination, write USDA, Director, Office of Civil Rights, Room 326-W, Whitten Building, 1400 Independence Avenue, SW, Washington, DC 20250-9410 or call (202) 720-5964 (voice or TDD). USDA is an equal opportunity provider and employer.